

# LDM136-151

## All-in-One Direct View LED Display User Guide

**IMPORTANT:** Please read this User Guide to obtain important information on installing and using your product in a safe manner, as well as registering your product for future service. Warranty information contained in this User Guide will describe your limited coverage from ViewSonic® Corporation, which is also found on our web site at <http://www.viewsonic.com> in English, or in specific languages using the Regional selection box of our website.

Model No. VS19933  
P/N: LDM136-151

## **Thank you for choosing ViewSonic®**

As a world-leading provider of visual solutions, ViewSonic® is dedicated to exceeding the world's expectations for technological evolution, innovation, and simplicity. At ViewSonic®, we believe that our products have the potential to make a positive impact in the world, and we are confident that the ViewSonic® product you have chosen will serve you well.

Once again, thank you for choosing ViewSonic®!

# Safety Precautions

Please read the following **Safety Precautions** before you start using the device.

- Keep this user guide in a safe place for later reference.
- Read all warnings and follow all instructions.
- Ensure there is no direct airflow from air conditioning blowing on the display.
- Do not use the device near water. To reduce the risk of fire or electric shock, do not expose the device to moisture.
- Avoid exposing the device to direct sunlight or other sources of sustained heat.
- Do not install near any heat sources such as radiators, heat registers, stoves, or other devices (including amplifiers) that may increase the temperature of the device to dangerous levels.
- When moving the device, be careful not to drop or bump the device on anything.
- Do not place the device on an uneven or unstable surface. The device may fall over resulting in an injury or a malfunction.
- Do not place any heavy objects on the device or connection cables.
- If smoke, an abnormal noise, or a strange odor is present, immediately turn the device off and call your dealer or ViewSonic®. It is dangerous to continue using the device.
- Do not attempt to circumvent the safety provisions of the polarized or grounding-type plug. A polarized plug has two blades with one wider than the other. A grounding-type plug has two blades and a third grounding prong. The wide blade and the third prong are provided for your safety. If the plug does not fit into your outlet, obtain an adapter and do not attempt to force the plug into the outlet.
- When connecting to a power outlet, DO NOT remove the grounding prong. Please ensure grounding prongs are NEVER REMOVED.
- Protect the power cord from being treaded upon or pinched, particularly at the plug, and at the point where it emerges from the equipment. Ensure that the power outlet is located near the equipment so that it is easily accessible.
- Only use attachments/accessories specified by the manufacturer.
- When a cart is used, use with caution when moving the cart/equipment combination to avoid injury from tipping over.
- Disconnect the power plug from the AC outlet if the device is not being used for a long period of time.



- Place the device in a well-ventilated area.
- Do not cover the surface of the display with any material.
- Do not block the air circulation around the display.
- Keep flammable materials away from the display.
- Refer all servicing to qualified service personnel. Service will be required when the unit has been damaged in any way, such as:
  - » if the power supply cord or plug is damaged;
  - » if liquid is spilled onto or objects fall in the unit;
  - » if the unit is exposed to moisture;
  - » if the unit does not operate normally or has been dropped.
- Do not assemble the display by yourself.
- This panel is an advanced product that contains millions of pixels. You may occasionally see pixel spots when viewing the screen. Since these deactivated pixels are not a defect, the performance and reliability of the product is not affected. For more information, please see page 87.



# Contents

<b>Safety Precautions.....</b>	<b>3</b>
<b>Introduction .....</b>	<b>9</b>
Package Contents .....	9
Product Overview .....	11
Front View .....	11
Rear View .....	11
Control Panel and I/O .....	12
I/O Ports .....	13
Remote Control .....	14
Bluetooth Remote Control Pairing .....	14
Remote Control Receiver Range .....	15
IR Extension .....	15
Inserting Remote Control Batteries .....	16
<b>Making Connections .....</b>	<b>17</b>
Connecting to Video .....	17
HDMI .....	17
HDMI Out .....	17
USB Connection .....	18
USB Type A .....	18
USB Type C .....	18
Network Connection.....	19
LAN .....	19
Control Connection .....	20
RS-232 (DB 9-pin) .....	20
RJ45 (LAN) .....	20
Audio Connection .....	21
Audio Out .....	21
SPDIF .....	21

<b>Using Your Display.....</b>	<b>22</b>
Turning the LED Display On/Off.....	22
Home Screen .....	23
Navigating the Home Screen .....	24
Remote Control .....	24
Keyboard and Mouse .....	24
App Center.....	25
Input Source .....	26
Settings.....	27
Settings Menu Tree .....	28
Network.....	31
Dehumidification Service .....	34
Device.....	35
System .....	39
On-Screen Display (OSD) Menu .....	41
On-Screen Display (OSD) Menu Tree .....	42
Menu Options .....	47
Picture .....	47
Screen.....	49
PBP (Picture-by-Picture).....	50
PIP (Picture-in-Picture).....	51
Audio .....	52
Time.....	53
Advanced.....	54
About.....	56

<b>Pre-installed Applications.....</b>	<b>57</b>
vCast .....	57
Display Group Settings .....	59
Synchronized Group Screen All the Time .....	61
Share a Screen to the Display Group (One to Many Casting).....	61
Moderator Mode .....	62
Broadcast .....	63
Multiple Screen Sharing .....	63
Preview Screen.....	63
Touch.....	63
Casting from Windows, MacBook, and Chrome Devices .....	64
Casting from Android Devices .....	66
Casting from Apple iOS Devices .....	70
Connecting to a ViewBoard from a Mobile Device .....	73
Other Default Applications .....	74
Browser .....	74
OfficeSuite.....	75
vSweeper.....	76
<b>Appendix.....</b>	<b>77</b>
Specifications.....	77
Timing Chart .....	79
HDMI (PC).....	79
HDMI (Video).....	80
Supported Media Formats.....	81
LED Display Stuck Pixel Definition .....	87
Maintenance Tools .....	88
Vacuum Suction Tool (LED Module Maintenance Tool).....	88
System Control Box Maintenance Tool .....	91
Troubleshooting .....	92
General.....	92
Video Not Working Properly .....	93
Audio Not Working Properly .....	93
Maintenance.....	95
General Precautions.....	95
Initial Operation .....	95
Front Panel Cleaning Instructions .....	95
Cabinet Cleaning Instructions .....	96
Regular Use .....	96

<b>RS-232 Protocol</b> .....	<b>97</b>
Description .....	97
RS-232 Hardware Specification .....	97
RS-232 Communication Setting.....	97
Command Table.....	98
Get Operation Time Example .....	100
<b>Regulatory and Service Information</b> .....	<b>101</b>
Compliance Information.....	101
FCC Compliance Statement.....	101
FCC Radiation Exposure Statement.....	102
IC Warning Statement .....	102
Country Code Statement.....	102
IC Radiation Exposure Statement.....	103
CE Conformity for European Countries .....	103
Declaration of RoHS2 Compliance.....	104
European Union Regulatory Conformance .....	105
Indian Restriction of Hazardous Substances .....	105
Product Disposal at End of Product Life .....	105
Copyright Information .....	106
Customer Service.....	107
Limited Warranty .....	108
Mexico Limited Warranty.....	111

# Introduction

## Package Contents

Item	Description	Quantity	Note
Installation Guide		1	
LED Display	Cabinet Section	5	One Left (E), three Middle (D, C, B), and one Right (A).
	LED Module	100	The quantity of spare LED modules varies by country.
Screen Bezel		5 x Left 5 x Right	
System Control Box	System Control Box	2	
	System Control Box Cover	2	
	Connector Plate	1	
	System Control Box Maintenance Tool (LD-MK-004)	1	
Wall Installation	Wall Mount Brackets	4	2 x 1799 mm 2 x 1199 mm
	Wall Mount Connector Plate	2	
Accessories	Screws	20 x M8 x 80 mm 22 x M8 nuts 74 x M8 x 20 mm 12 x PM6 x 10 mm 16 x M3 x 10 mm 16 x M3 x 6 mm 5 x M2.5 x 4 mm	
	Hand Tools	2 x Cross-head screwdrivers 2 x Ratchet wrenches	
	Anti-Static Gloves	2 pairs	

Item	Description	Quantity	Note
Remote Control		1	
Ethernet Cable (3.5 m)		1	
IR Extension Cable (3 m)		1	
Vacuum Suction Tool (LD-MK-003)		1	
USB Thumb Drive		1	

**NOTE:**

- This product is packed in a wooden crate.
- Due to the size and weight, it is recommended that two or more people handle it.
- The base stand (trolley) is an optional accessory and sold separately.

# Product Overview

## Front View

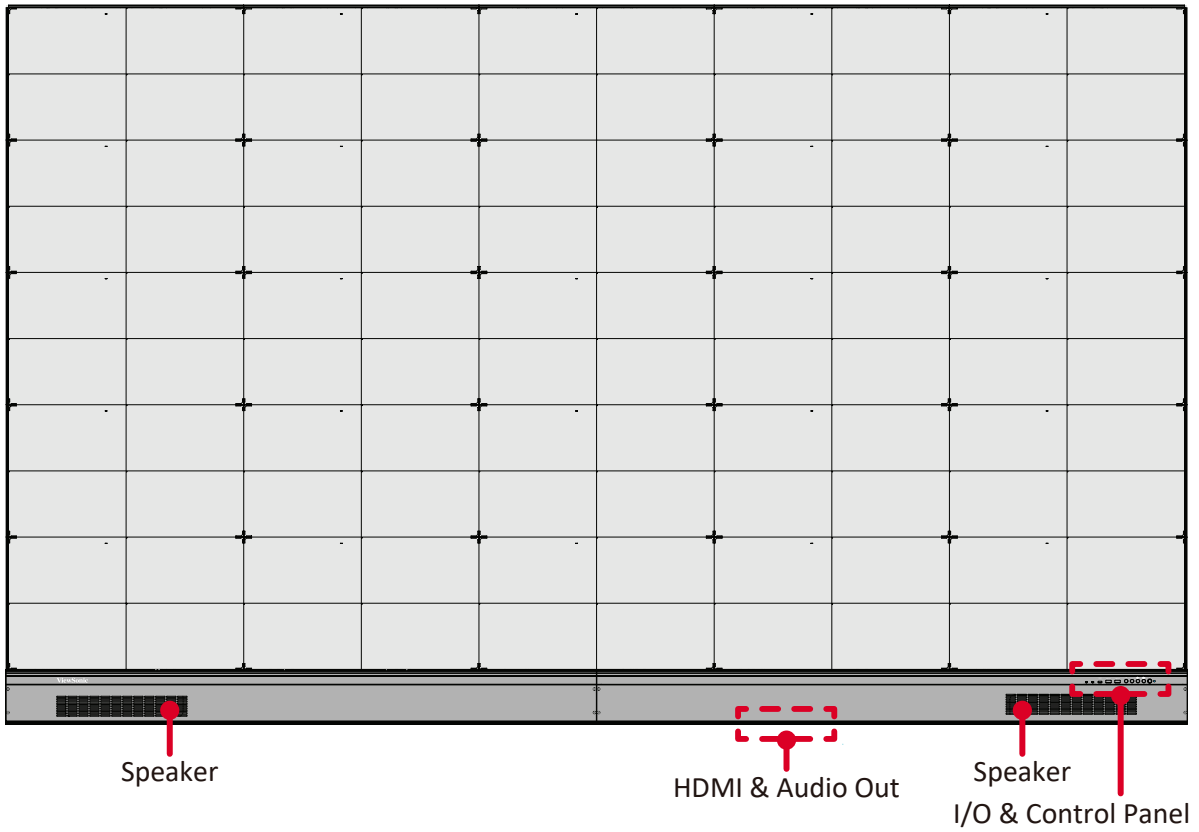

## Rear View

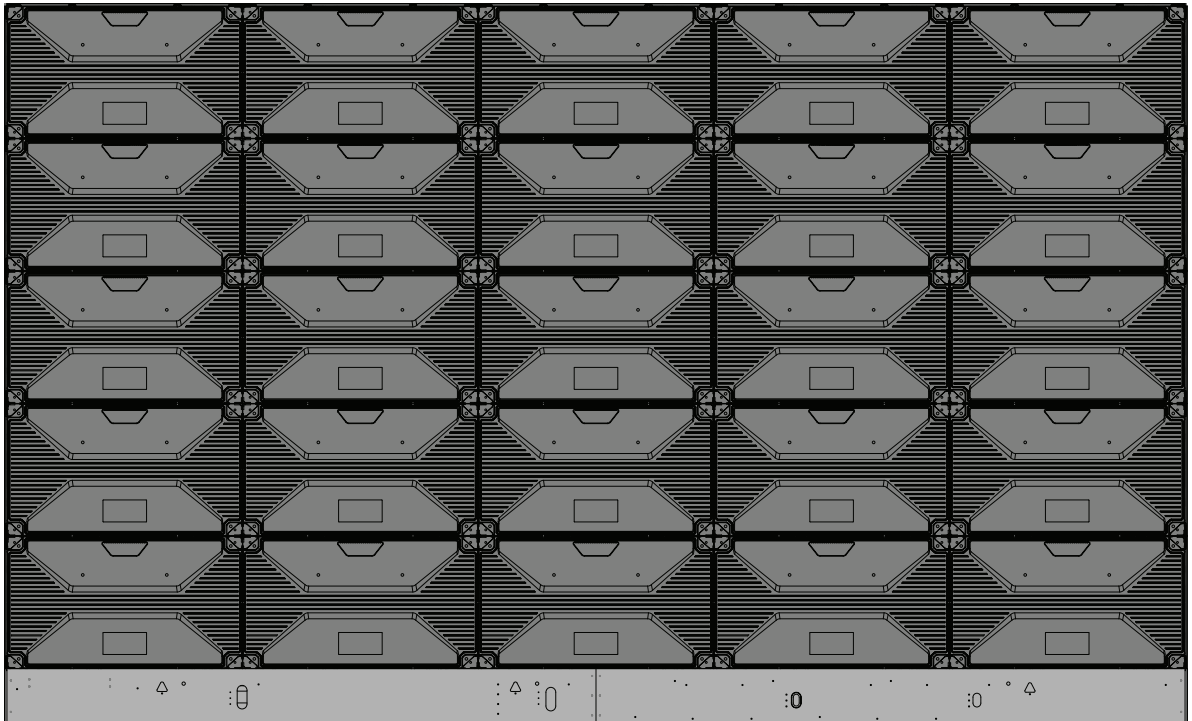

# Control Panel and I/O

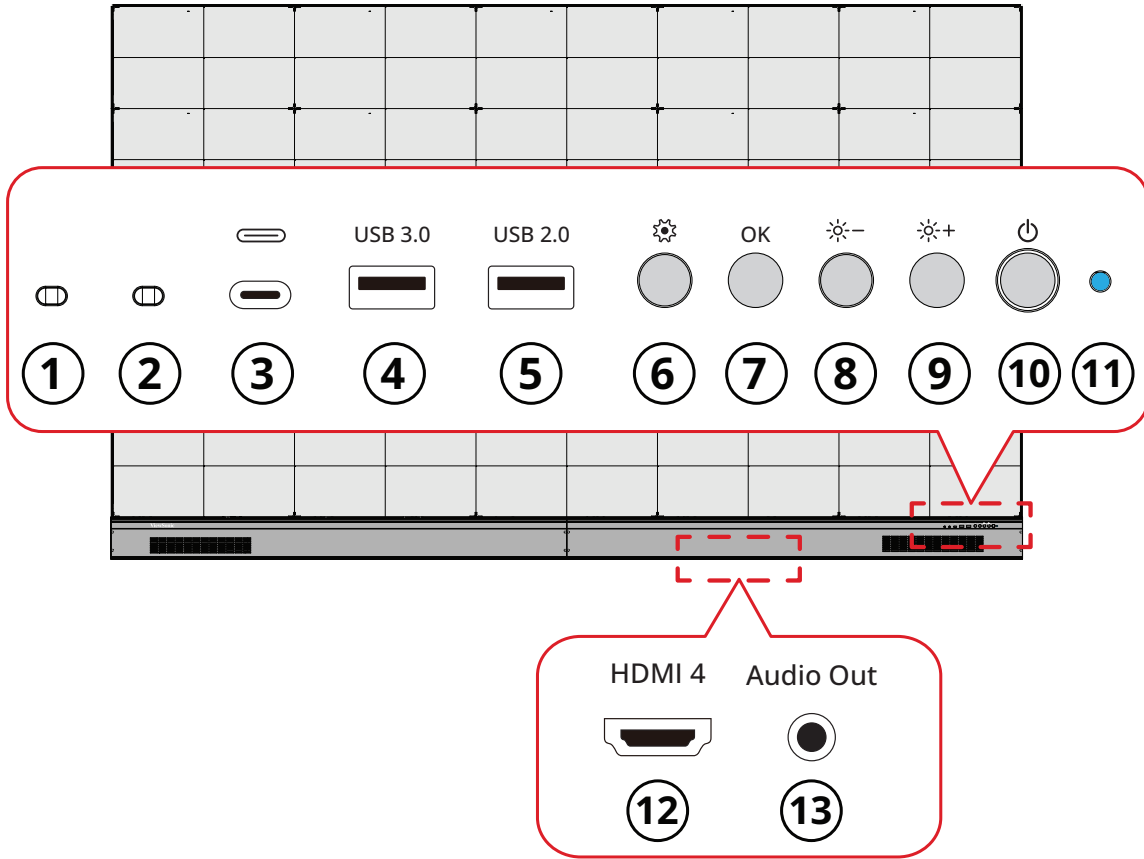

Item	Description
1	Light Sensor Ambient light sensor.
2	IR Receiver Receiver for remote control signal.
3	USB Type C USB 2.0 support (5V/1.0A).
4	USB 3.0 USB Reader (5V/0.9A).
5	USB 2.0 USB Reader (5V/0.5A).
6	Menu Open the display settings or On-Screen Display (OSD) Menu.
7	Brightness/OK <ul style="list-style-type: none"> <li>Brightness adjustment button.</li> <li>Confirm selection when the OSD Menu is open.</li> </ul>
8	Brightness Decrease Decrease the brightness level.
9	Brightness Increase Increase the brightness level.
10	Power Power on, standby and wake button.
11	Indicator Light Power status indicator light.
12	HDMI 4 High definition input: PIP/PBP, connect to PC with HDMI output, set-top box, or other video device.
13	Audio Out Audio output to an external audio device.



# I/O Ports

**NOTE:** The below I/O ports are accessed by removing the right side of the System Control Box Cover.

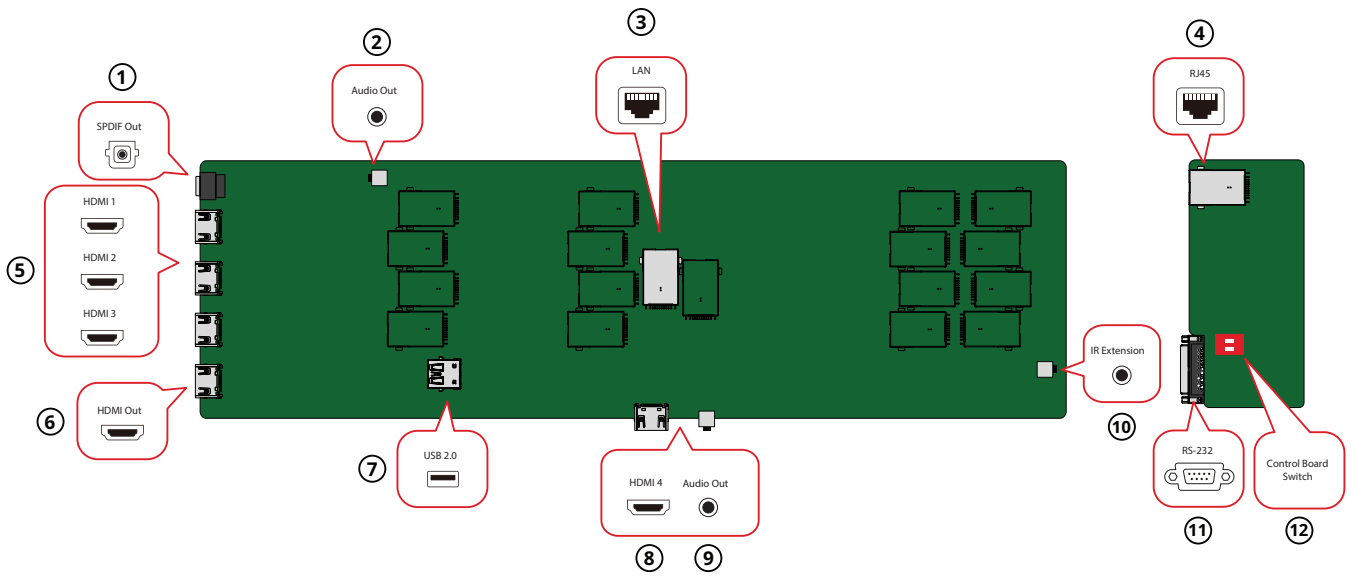

Item		Description
1	SPDIF Out	Multi-channel optical audio signal.
2	Audio Out	Audio output to an external audio device.
3	LAN	Standard RJ45 (10M/100M/1000M) Internet connection interface.
4	RJ45	Standard RJ45 control connection interface.
5	HDMI 1/2/3	High definition input: PIP/PBP, connect to PC with HDMI output, set-top box, or other video device.
6	HDMI Out	Extend the display's content out to another display device.
7	USB 2.0	USB Type A port for power (5V/2A).
8	HDMI 4	High definition input: PIP/PBP, connect to PC with HDMI output, set-top box, or other video device. <b>NOTE:</b> This port can also be accessed without removing the System Control Box Cover.
9	Audio Out	Audio output to an external audio device. <b>NOTE:</b> This port can also be accessed without removing the System Control Box Cover.
10	IR Extension	Connection point for an extended IR receiver.
11	RS-232	Serial control port.
12	Control Board Switch	Control switch for the control board. <b>NOTE:</b> Make sure to switch to the left for RS-232 control.

# Remote Control

Button		Description
1	Power	Turn the display on or off.
2	Source	Select the input source.
3	Brightness	Adjust the screen's brightness level.
4	Blank	Change the current screen to a black screen.
5	Directional	Navigate menus and make adjustments.
6	OK	Confirm the selection.
7	Menu	Open the display settings or On-Screen Display (OSD) Menu.
8	Return	Return to the previous screen or exit a menu.
9	Home	Go to the Home screen.
10	Volume Control	Adjust the volume level.
11	Mute	Turn off the display's sound.
12	Forwards/Backwards	Move to next or previous content.
13	Play/Pause	Play or pause content.

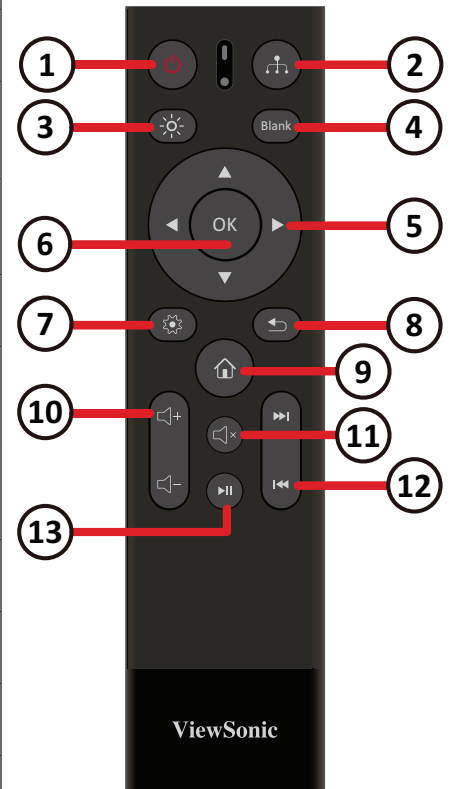

## Bluetooth Remote Control Pairing

To pair the remote control:

1. Make sure Bluetooth is enabled, go to: **Settings > Network > Bluetooth > Enable**.
2. Press and hold the **Menu** (⚙️) and **Return** (↩️) buttons for approximately three seconds until the indicator on the remote control flashes blue.
3. If the pairing is successful, a pop-up message will appear on the screen.

**NOTE:** If the pairing is unsuccessful after one minute, please try again by repeating Step 1 above.

## Remote Control Receiver Range

The operating range of the remote control is shown here. It has an effective range of 6 meters (20 feet), 30° degrees left and right. Please make sure there is nothing obstructing the remote control's signal to the receiver.

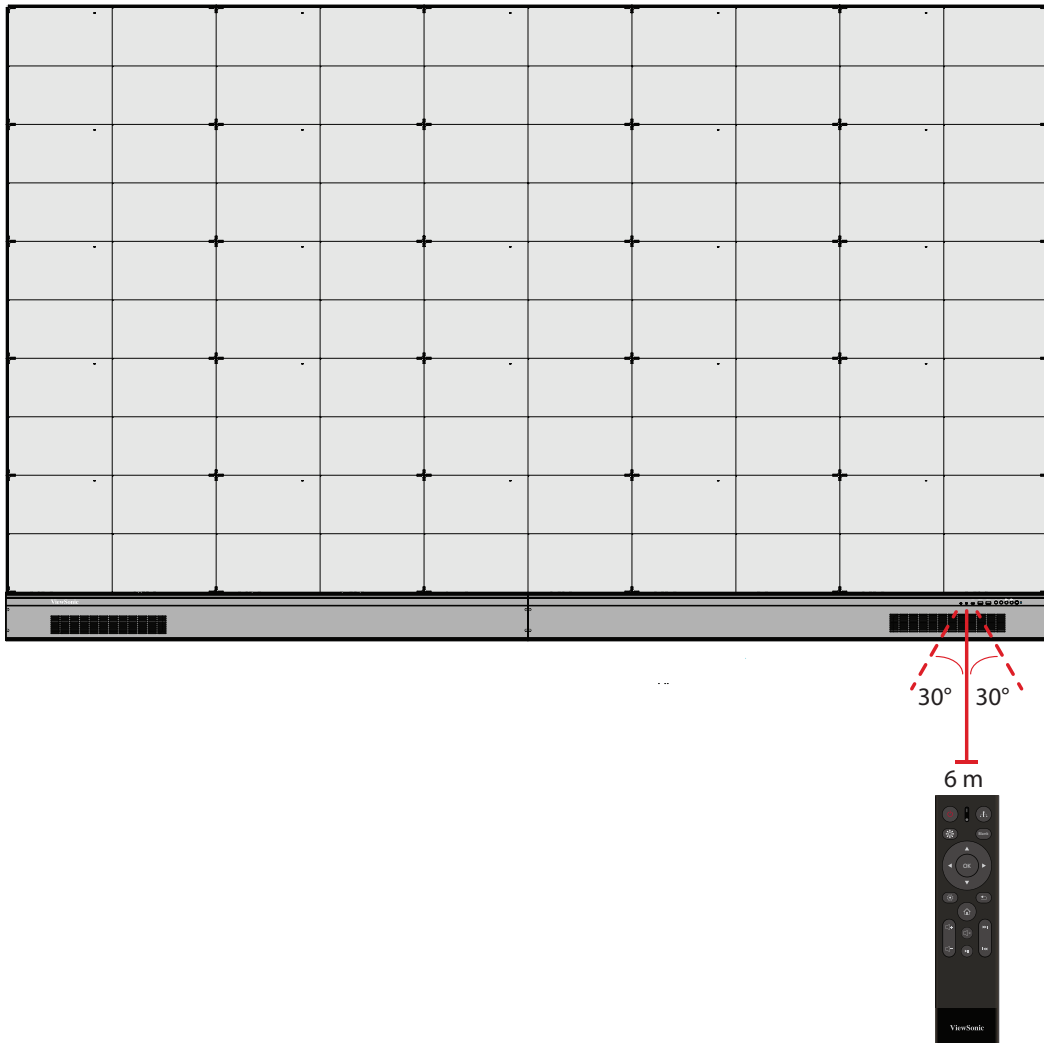

## IR Extension

If an additional IR Receiver is needed, an IR extension cable can be connected to the **IR Extension** port of the display.

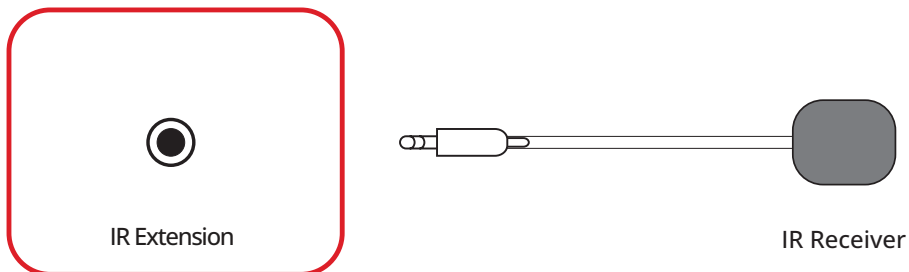

**NOTE:** The **IR Extension** port is accessed by removing the System Control Box Cover.

## Inserting Remote Control Batteries

The remote control is powered by two 1.5V "AAA" batteries.

To insert batteries into the remote control:

1. Remove the cover on the rear of the remote control.
2. Insert two "AAA" batteries, ensuring the positive (+) symbol on the battery matches the positive (+) symbol on the battery post.
3. Replace the cover by aligning it with the slot on the remote control and snapping the latch shut.

**WARNING:** There is a risk of explosion if batteries are installed with incorrect polarity.

### NOTE:

- It is recommended that you do not mix battery types.
- Avoid exposure to heat or steam.
- Do not allow water or other liquids to splash on the remote control. If the remote control becomes wet, wipe it dry immediately.
- Always dispose of old batteries in an environmentally friendly way. Contact your local government for more information on how to dispose of batteries safely.

# Making Connections

## Connecting to Video

### HDMI



Connect an HDMI cable from your external device to the **HDMI 1/HDMI 2/HDMI 3/HDMI 4** port on the display.

**NOTE:** The **HDMI 1/HDMI 2/HDMI 3** port is accessed by removing the System Control Box Cover.

### HDMI Out



To output video via an external display device, connect an HDMI cable to the **HDMI IN** port of your external display device, and the other end to the **HDMI OUT** port of the display.

**NOTE:** The **HDMI OUT** port is accessed by removing the System Control Box Cover.

# USB Connection

## USB Type A

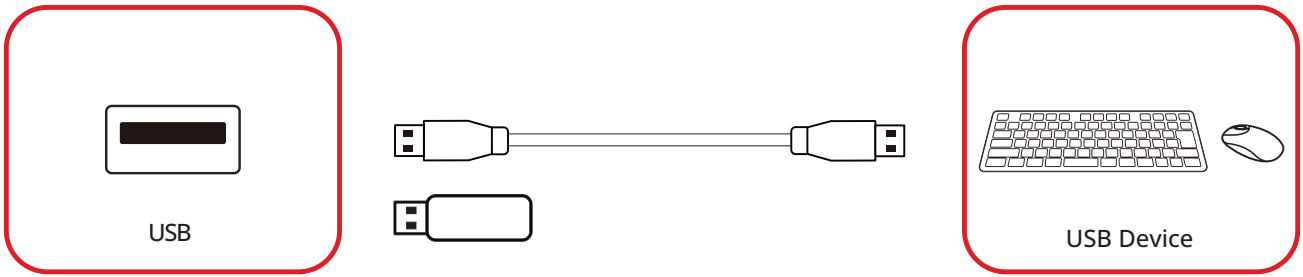

Plug the USB device or storage drive into a USB Type A (**USB 3.0** or **USB 2.0**) port on the display's control panel.

**NOTE:** An additional USB Type A port can be accessed by removing the System Control Box Cover; however, it is for power transfer only (5V/0.5A).

## USB Type C

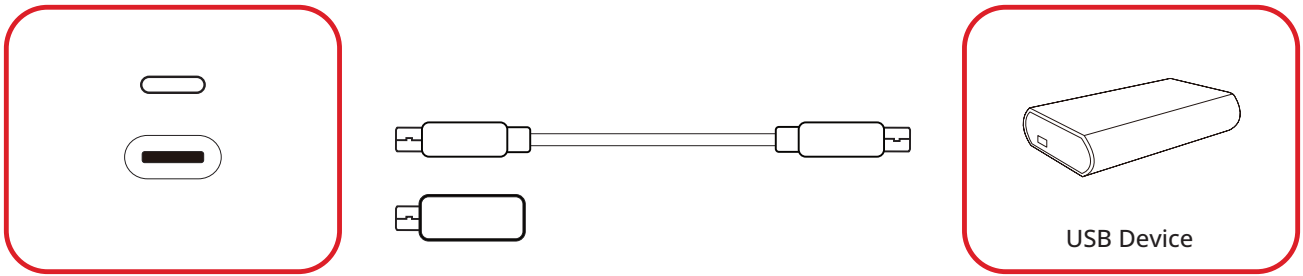

Plug the USB device or storage drive into the USB Type C (≡) port on the display's control panel.

**NOTE:** The USB Type C port is for data transfer only.

# Network Connection

## LAN



To connect to a network, connect an Ethernet cable to your network, then connect the other end to the **LAN** port of the display.

**NOTE:** The **LAN** port is accessed by removing the System Control Box Cover.

# Control Connection

## RS-232 (DB 9-pin)



When you use a RS-232 serial cable to connect the display to an external computer or control system, certain functions can be controlled remotely such as: power on and off, volume adjustment, input select, brightness, and more.

**NOTE:** The **RS-232** port is accessed by removing the System Control Box Cover.

## RJ45 (LAN)

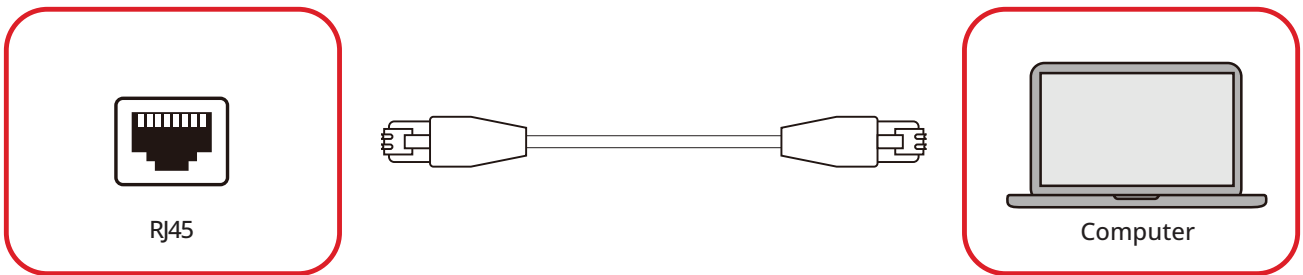

When you use an Ethernet cable to connect the display to an external computer or control system, certain functions can be controlled remotely such as: power on and off, volume adjustment, input select, brightness, and more.

**NOTE:** The **RJ45** port is accessed by removing the System Control Box Cover.



# Audio Connection

## Audio Out

To play audio from the display through an external speaker, connect one end of an audio cable to the external speaker, and the other end to the display's **Audio Out** port.

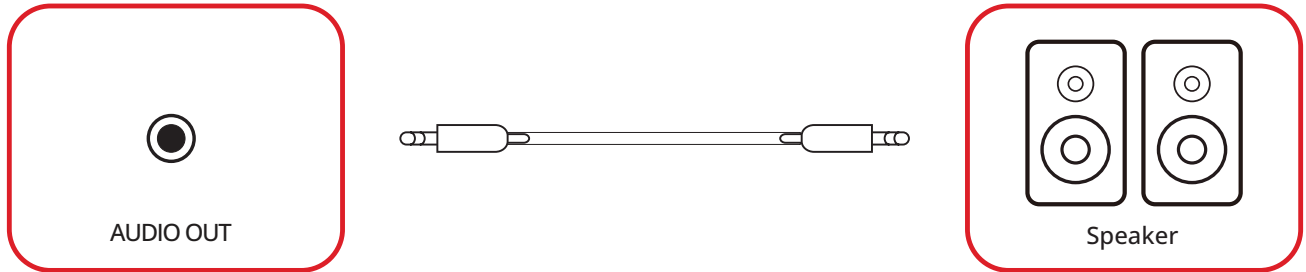

**NOTE:** The display is equipped with two **Audio Out** ports, one can be accessed externally, while the other is accessed by removing the System Control Box Cover.

## SPDIF

To play audio from the display through an external speaker, connect one end of an optical cable to the external speaker, and the other end to the display's **SPDIF Out** port.

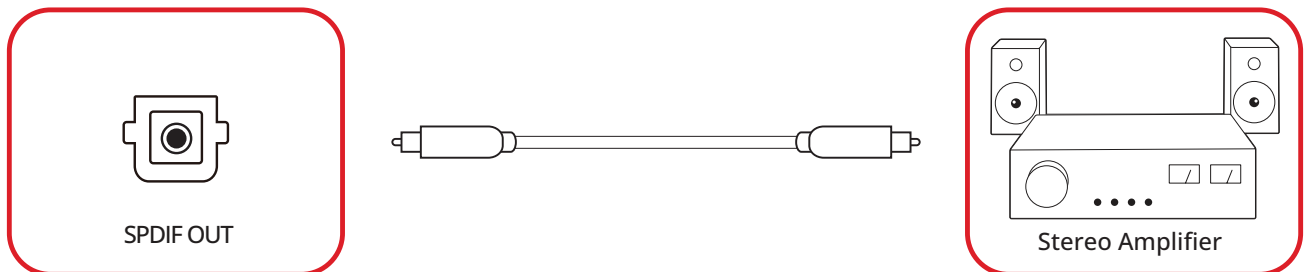

**NOTE:** The **SPDIF Out** port is accessed by removing the System Control Box Cover.

# Using Your Display

## Turning the LED Display On/Off

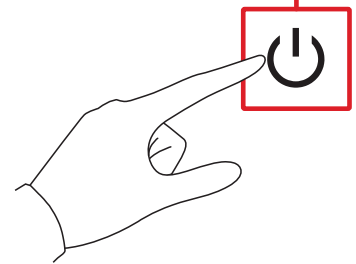
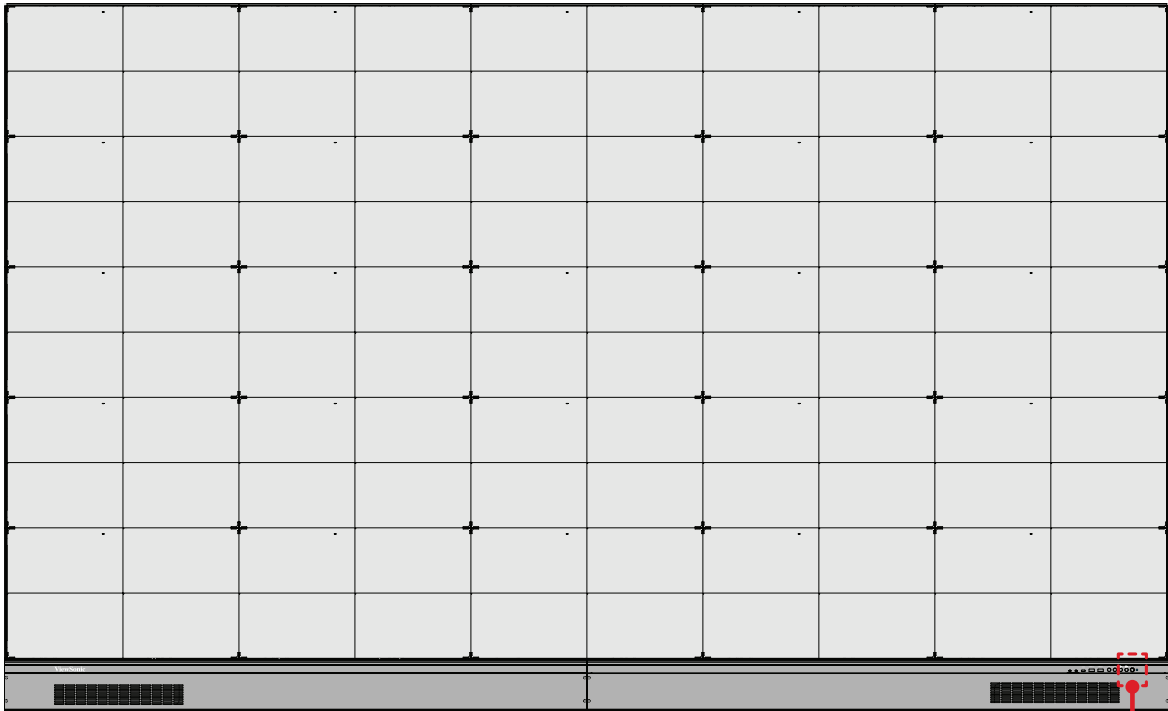

1. Make sure the power cord is connected and plugged into a power outlet.
2. Press the **⏻ Power** button to turn on the display.
3. To turn the display off, press the **⏻ Power** button again.

# Home Screen

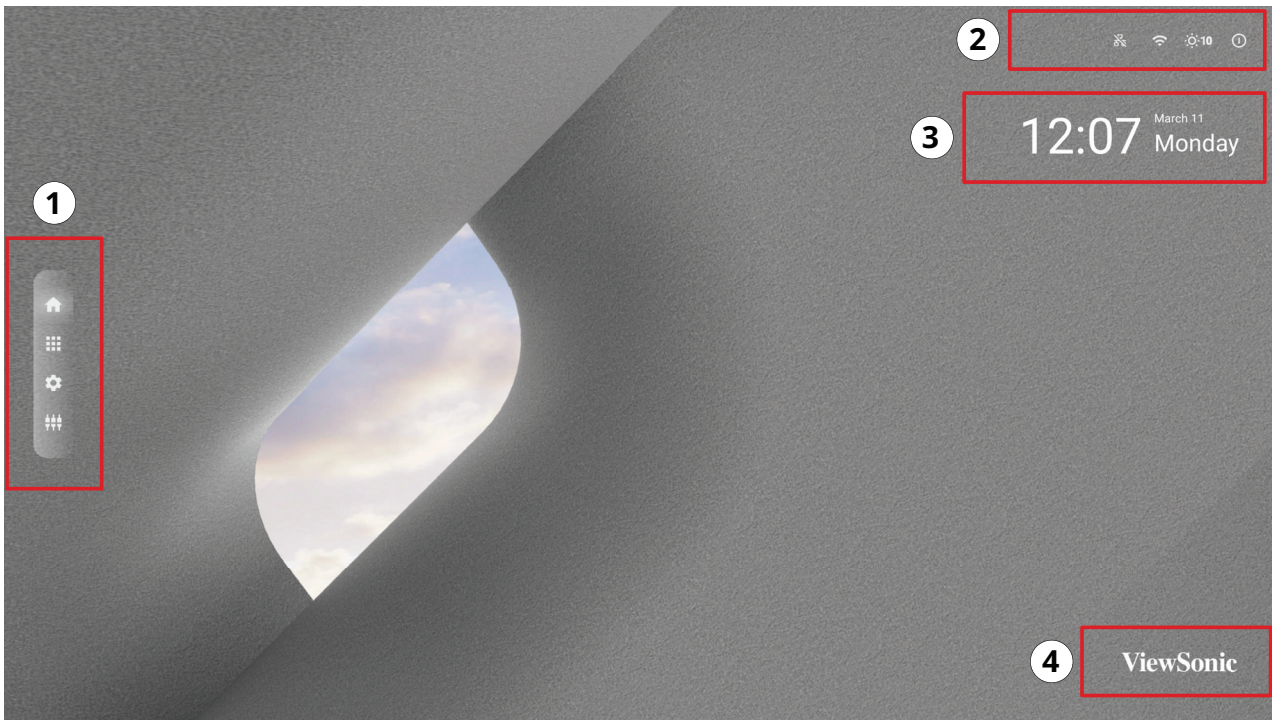

Number	Item	Description
1	Main Menu	Access the Home Screen, App Center, Settings, and Input Source.
2	Quick Access	Quick access to WAN/LAN, Wi-Fi, Brightness, and Power. <b>NOTE:</b> Only supported by keyboard and mouse.
3	Date & Time	Adjust and show or hide the Date & Time by going to: <b>Settings &gt; Device &gt; Launcher Settings</b>
4	ViewSonic Logo	Show or hide the logo by going to: <b>Settings &gt; Display &gt; Launcher Settings</b>

# Navigating the Home Screen

## Remote Control

The remote control can be used to easily navigate the Home Screen. When using the remote control, ensure it is kept within the IR receiver range as shown below:

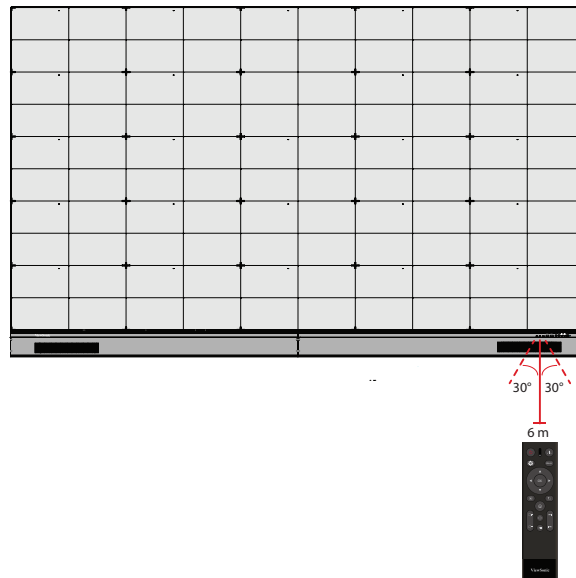

## Keyboard and Mouse

When connected to the USB Type A port of the display, a keyboard and mouse can also be used to navigate the Home Screen.

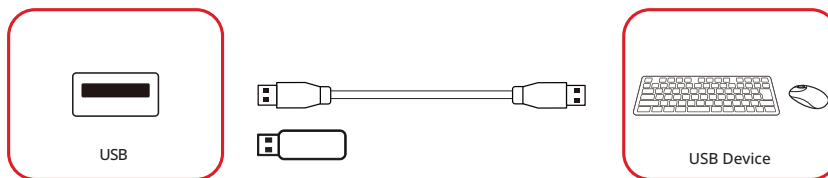

An orange mouse pointer will appear on the display when used.

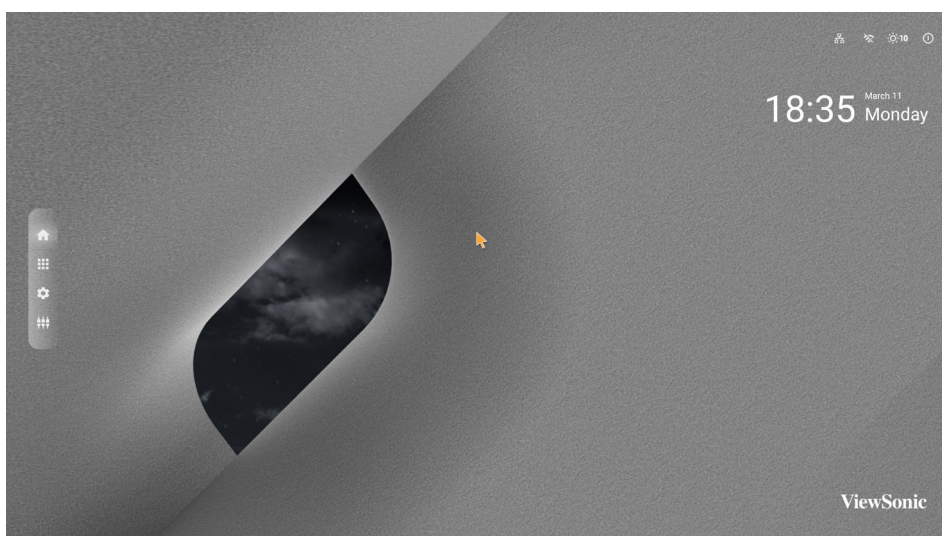







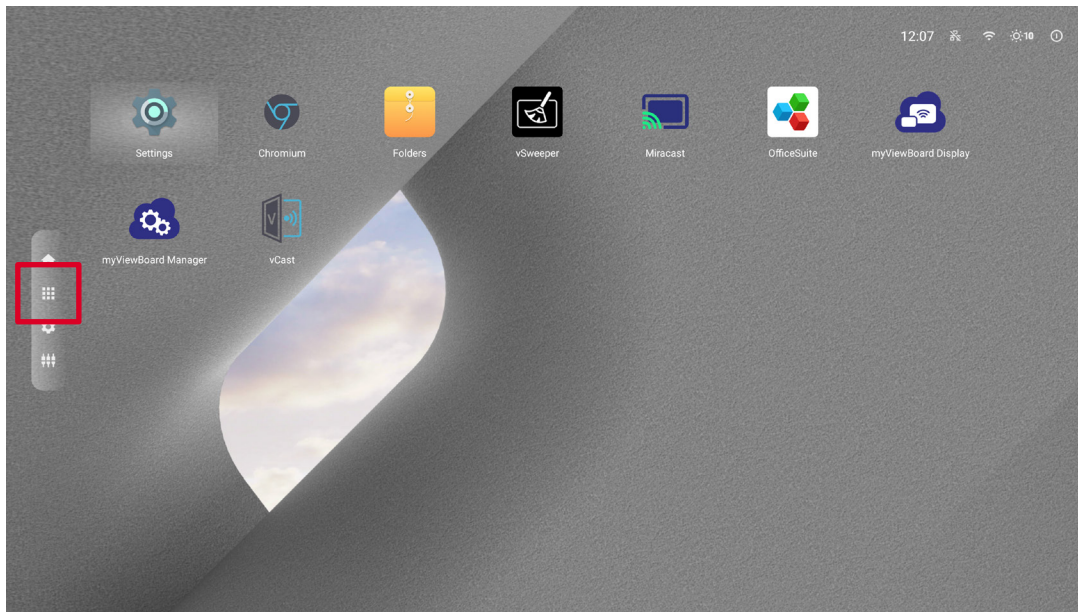

- The left mouse button will confirm actions.
- The right mouse button will go back to the previous layer.

# App Center

Installed applications will be in the App Center.



Icon	Name	Description
	Settings	Adjust and view the display's settings.
	Chromium	Web browser.
	Folders	File explorer.
	vSweeper	Resource management tool.
	Miracast	Wireless screen mirroring.
	OfficeSuite	Create documents, spreadsheets, and presentations.
	myViewBoard Display	Wirelessly mirror your desktop.
	myViewBoard Manager	Remote device management.
	vCast	Receive casted content from other devices.

**NOTE:** Pre-installed applications are subject to change without notice.



# Input Source

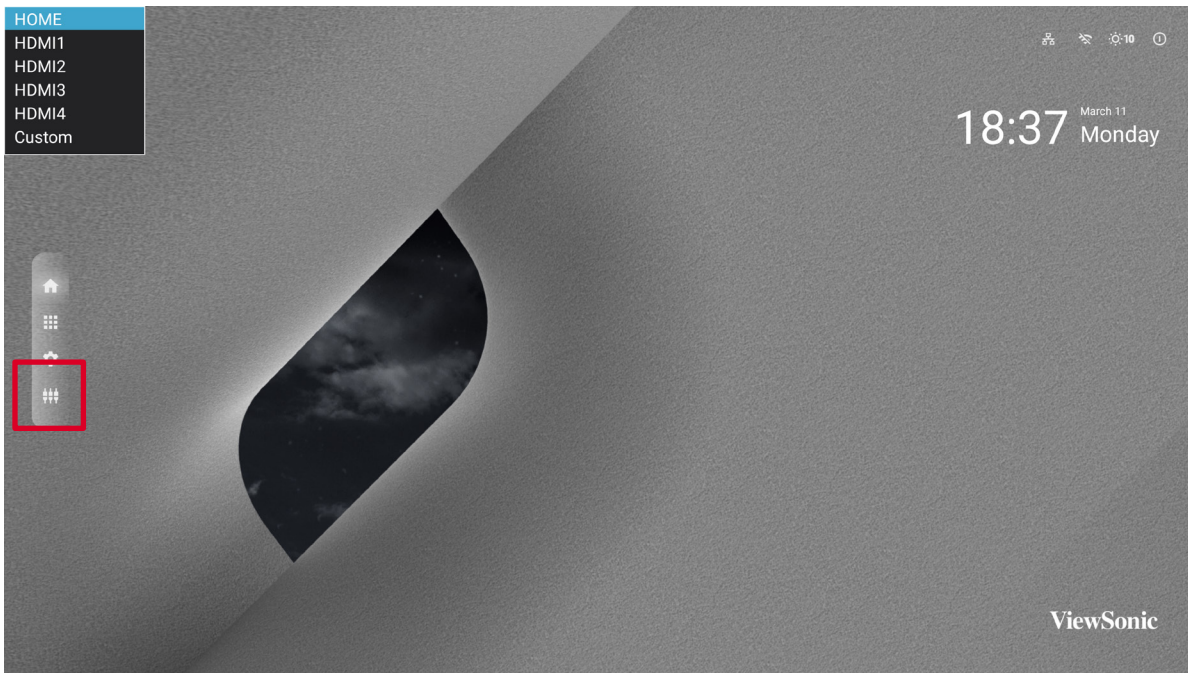

The display supports eight input sources: **Home**, **HDMI 1**, **HDMI 2**, **HDMI 3**, **HDMI 4**, and **Custom**.

**NOTE:** The **Custom** input source is used to quickly access custom applications. To select the custom application, go to: **Settings > Device > Signage Display > Custom App**.

# Settings

Adjust and view the display's settings.

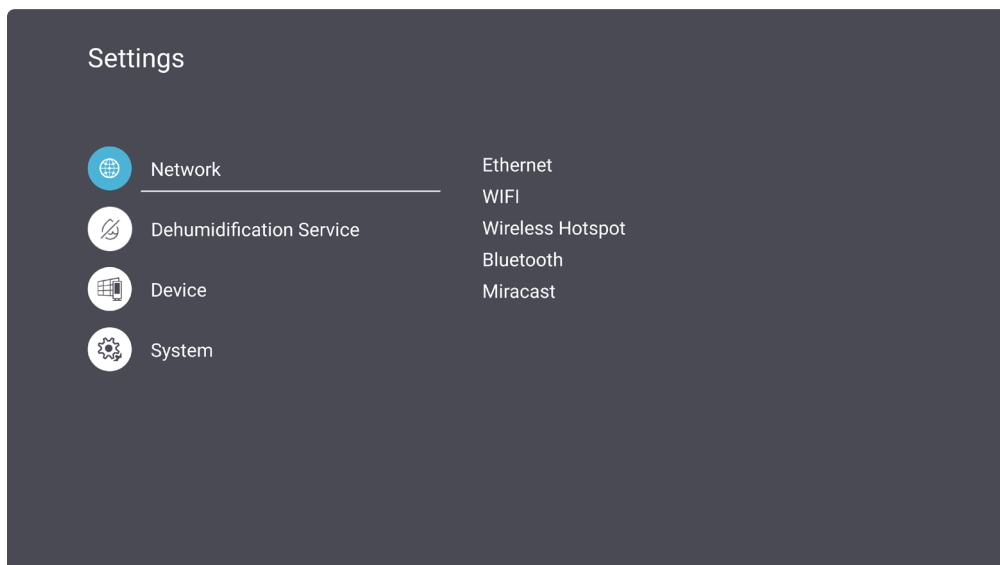
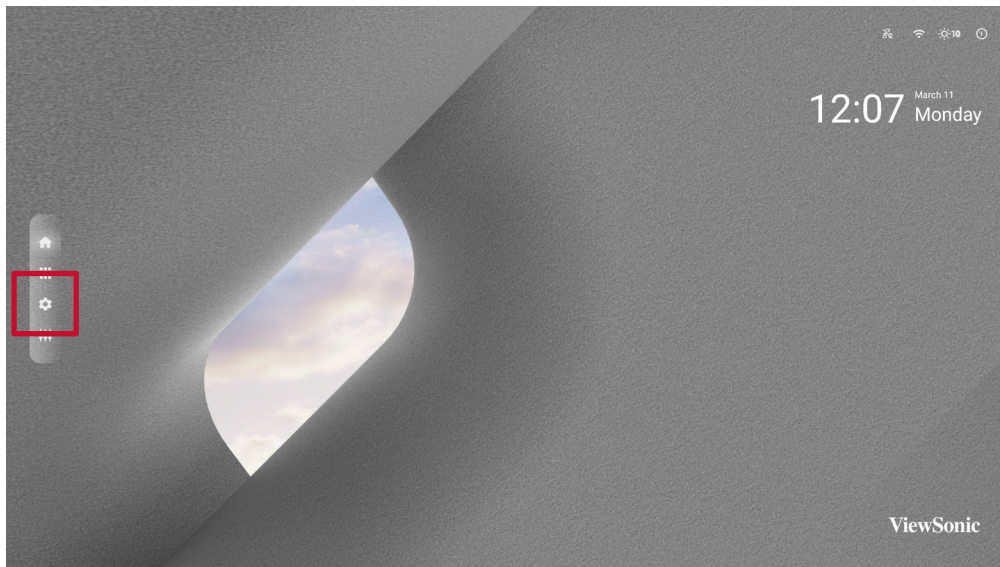

Menu	Description
<b>Network</b>	View and adjust Ethernet, Wi-Fi, Wireless Hotspot, Bluetooth, and Miracast settings.
<b>Dehumidification Service</b>	View and adjust dehumidification settings and start the dehumidification process.
<b>Device</b>	View and adjust Signage Display, System Tools, Display, Apps, Audio, Physical Keyboard, Input method, and Launcher settings.
<b>System</b>	View and adjust Date & Time and About settings.

## Settings Menu Tree

Main Menu	Sub-menu	Menu Option	
Network	Ethernet	Main Switch	Disable
			Enable
		Ethernet Configuration	Connection Type
			Mac Address
	Wi-Fi	Disable	
		Enable	
		Add Wi-Fi	
	Wireless Hotspot	Main Switch	Disable
			Enable
		Hotspot Configuration	Network Name
			Security Type
	Bluetooth	Bluetooth	Disable
			Enable
	Miracast	Available Device	
Main Switch		Disable	
	Enable		
Detail	Name		
Dehumidification Service	Dehumidification Settings	Dehumidification Level	Shutdown
			Low
			Middle
			High
	Begin Dehumidification Now		



Main Menu	Sub-menu	Menu Option	
Device	Signage Display	General Settings	Signage Display Name
			Boot Logo
		Source Settings	Custom App
		Credential Settings	Trusted Credentials
			User Credentials
			Install from Storage
			Clear Credentials
		Security	External Storage
			Unknown Sources
			Privacy and Copyright Protection
			App Authority
		System Tools	Clear Storage
	Internal Storage		
	USB Storage		
	Reset		Factory Reset
	Import & Export		Export Signage Display Settings
			Import Signage Display Settings
	Clone	Clone Media Files	
	Display	Font Size	
		Screen Saver	
	Apps	Running	
		All	
		Download	
	Physical Keyboard		
	Launcher Settings	ViewSonic Logo	On
			Off
		Date & Time	On
Off			
Theme			
Input Method			

Main Menu	Sub-menu	Menu Option	
System	Date & Time	Select Time Zone	
		NTP Server	
	About	Local System Updates	
		Online System Updates	
		Asset Tagging	
		Legal Information	
		Android Version	
		Kernel Version	
		Build Number	
		Operation Hours	

# Network

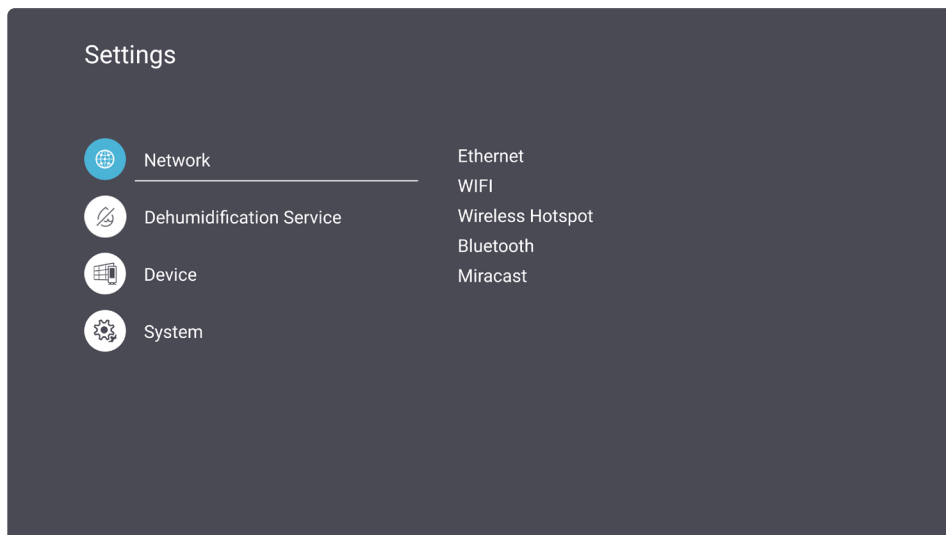

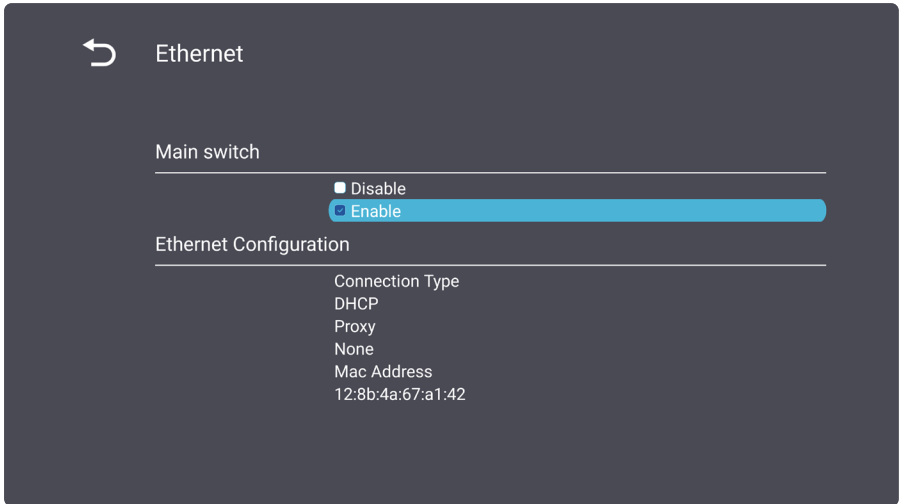
Sub-menu	Description
<b>Ethernet</b>	<p>Enable or disable Ethernet and configure it.</p>  <p>The screenshot shows the 'Ethernet' configuration screen. At the top, there is a back arrow and the title 'Ethernet'. Below this is the 'Main switch' section, which contains two radio buttons: 'Disable' and 'Enable'. The 'Enable' option is selected, indicated by a blue bar. Below the 'Main switch' is the 'Ethernet Configuration' section, which lists several settings: 'Connection Type' (set to DHCP), 'Proxy' (set to None), and 'Mac Address' (set to 12:8b:4a:67:a1:42).</p>

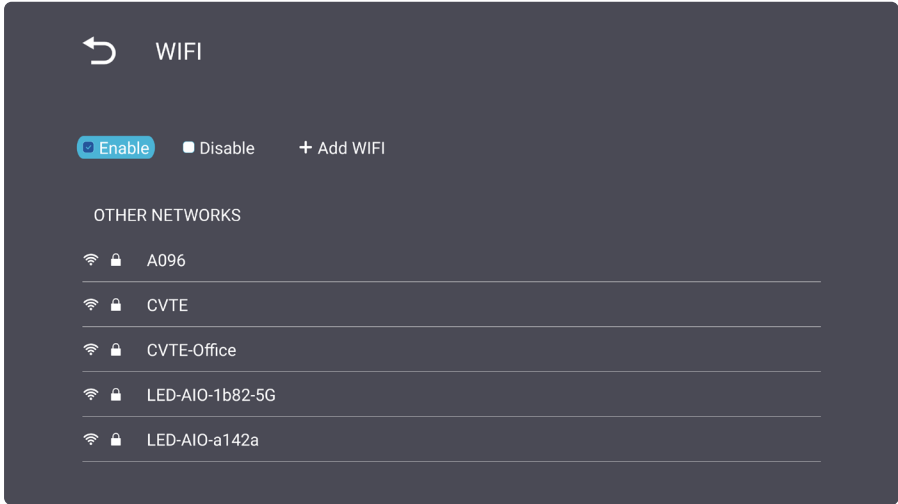
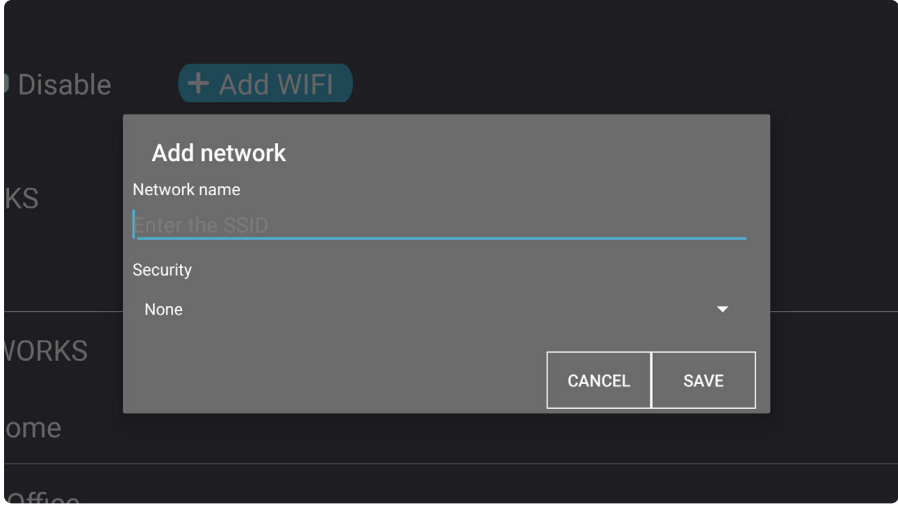
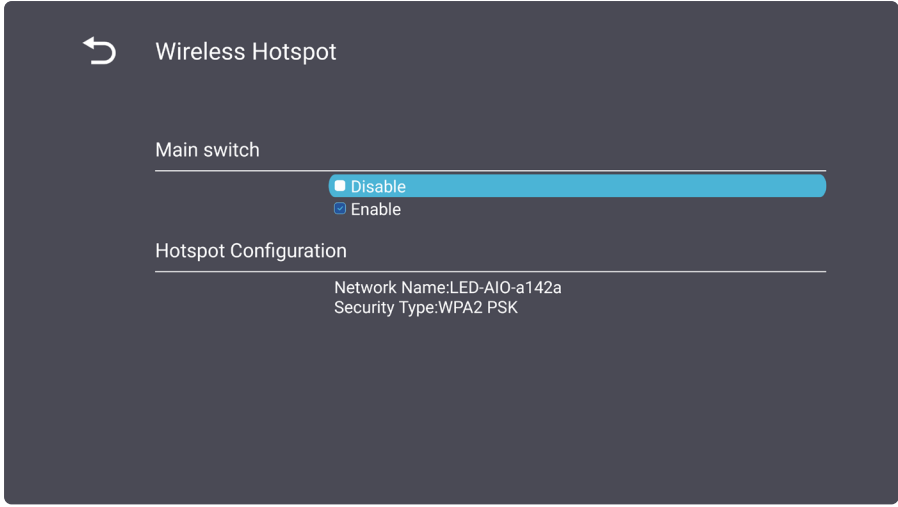
Sub-menu	Description
<p><b>Wi-Fi</b></p>	<p>Open the Wi-Fi selection interface to enable or disable Wi-Fi and connect to a Wi-Fi network.</p>  <p>You can also select <b>Add Network</b> in the Wi-Fi selection screen to manually add a Wi-Fi network.</p> 
<p><b>Wireless Hotspot</b></p>	<p>Enable or disable Wireless Hotspot. Once enabled, the hotspot name will be displayed and can be connected to.</p> 

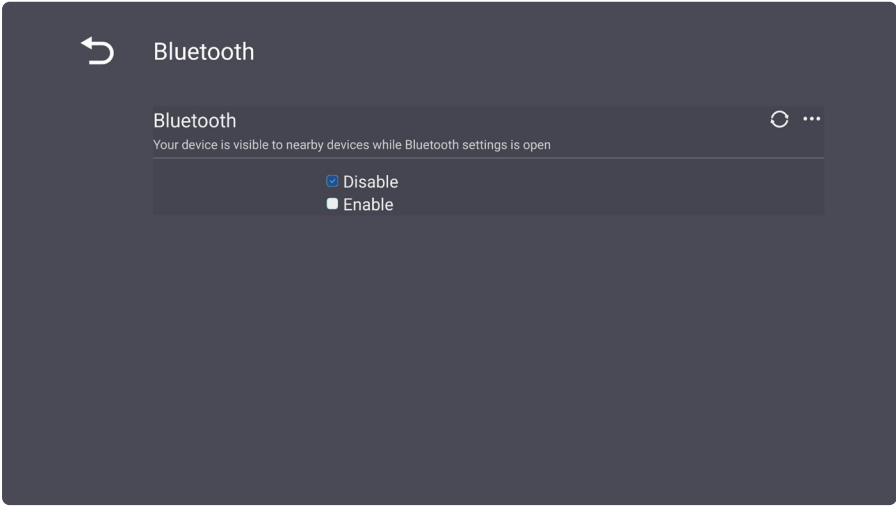
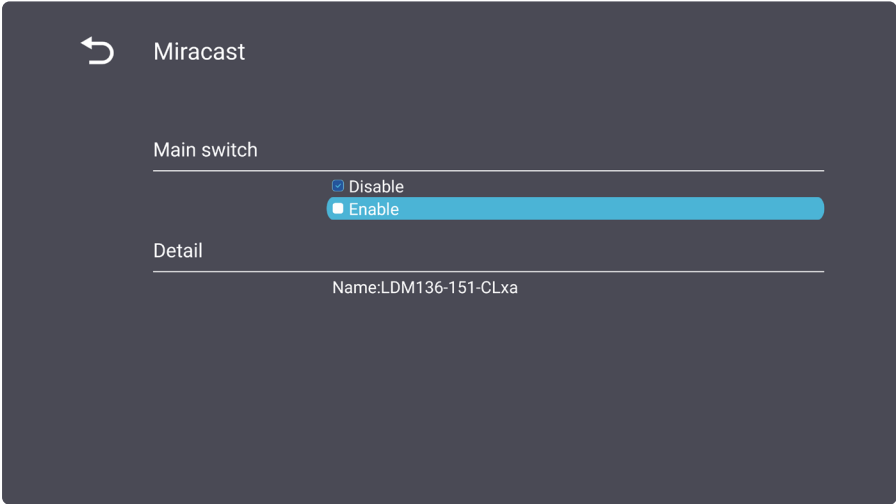
Sub-menu	Description
<p><b>Bluetooth</b></p>	<p>Enable or disable Bluetooth. Once enabled, available devices will be displayed and can be connected to.</p>  <p><b>NOTE:</b> The volume of a connected Bluetooth speaker cannot be adjusted with the remote control.</p>
<p><b>Miracast</b></p>	<p>Enable or disable Miracast.</p> 

# Dehumidification Service

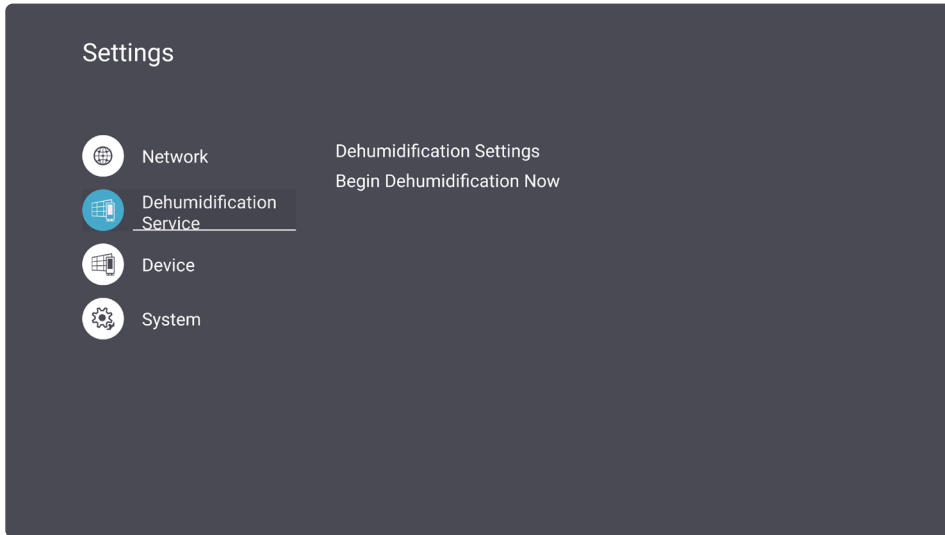

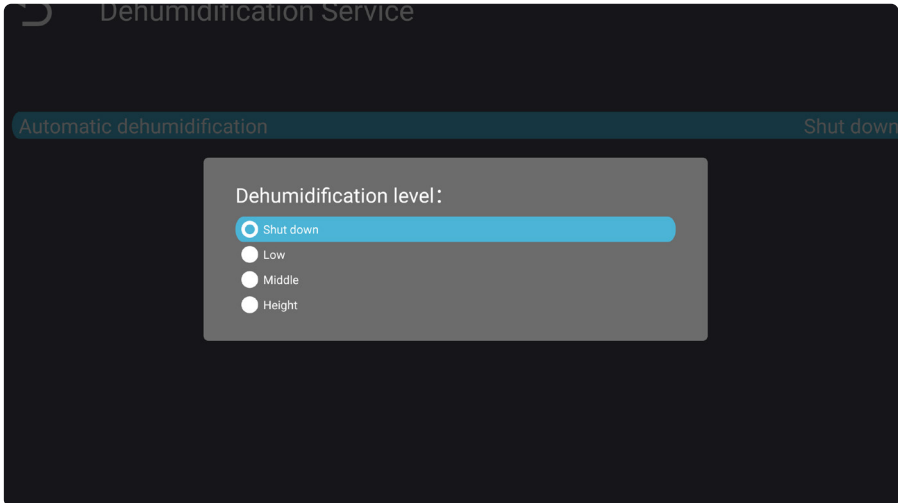
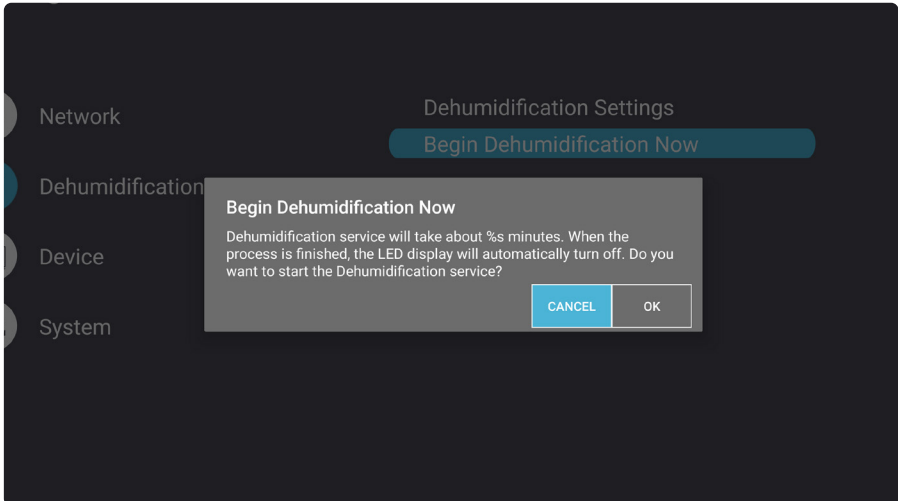
Sub-menu	Description
<p><b>Dehumidification Settings</b></p>	<p>Set the dehumidification level or shut it down.</p>  <p>The screenshot shows a dialog box titled 'Dehumidification Service'. It has two tabs: 'Automatic dehumidification' (selected) and 'Shut down'. The 'Dehumidification level:' section has four radio button options: 'Shut down' (selected), 'Low', 'Middle', and 'Height'.</p>
<p><b>Begin Dehumidification</b></p>	<p>Manually start the dehumidification process.</p>  <p>The screenshot shows the 'Settings' menu with 'Dehumidification Service' selected. A dialog box titled 'Begin Dehumidification Now' is displayed. The dialog contains the text: 'Dehumidification service will take about %s minutes. When the process is finished, the LED display will automatically turn off. Do you want to start the Dehumidification service?'. At the bottom right of the dialog are 'CANCEL' and 'OK' buttons.</p>

# Device

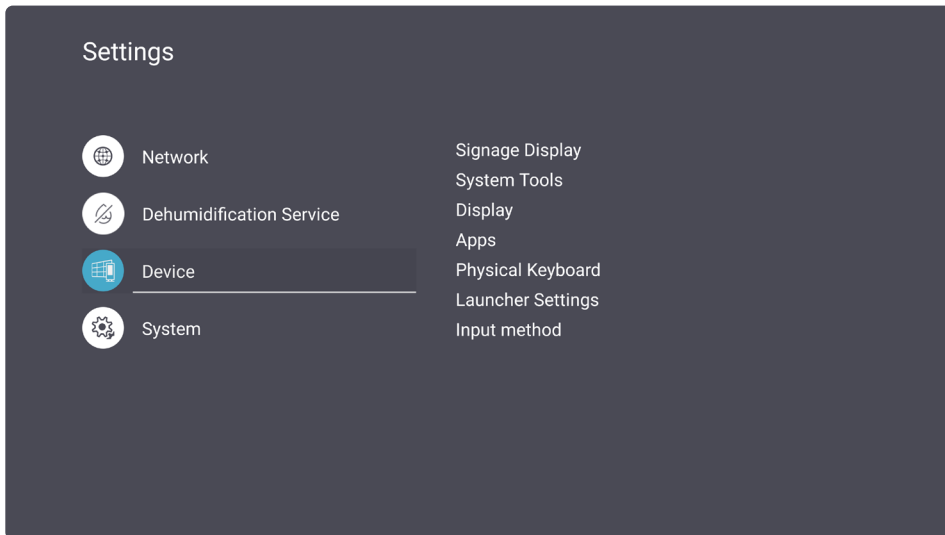

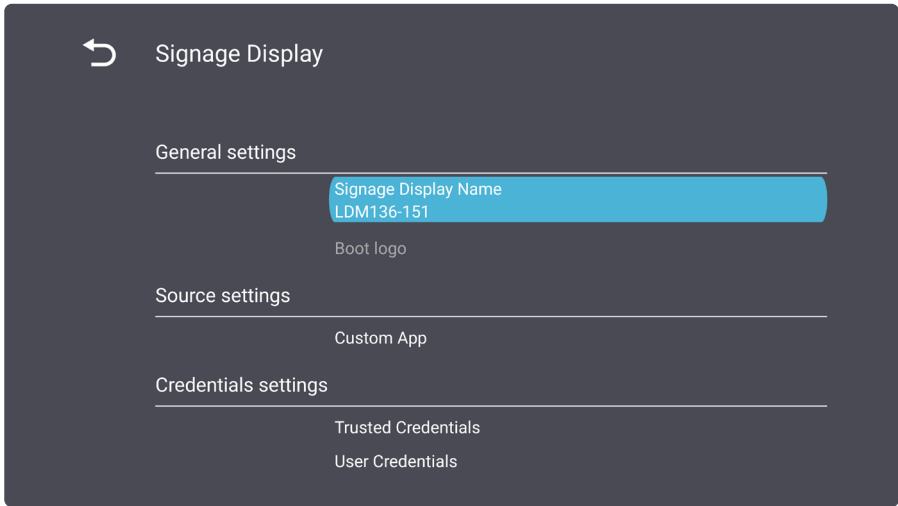
Sub-menu	Description
<p><b>Signage Display</b></p>	 <p><u>General Settings</u> Set the <b>Signage Display Name</b> and <b>Boot Logo</b>.</p> <p><u>Source Settings</u> Set the application to open when the <b>Custom</b> input source is selected.</p> <p><u>Credential Settings</u> View and clear credentials and install from storage.</p> <p><u>Security</u> Review privacy and copyright protections, allow external USB storage and installing applications from unknown sources.</p>

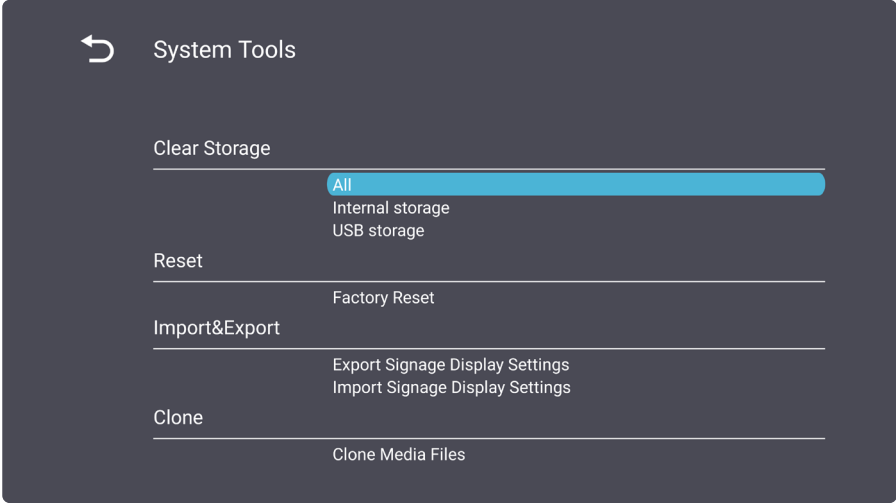
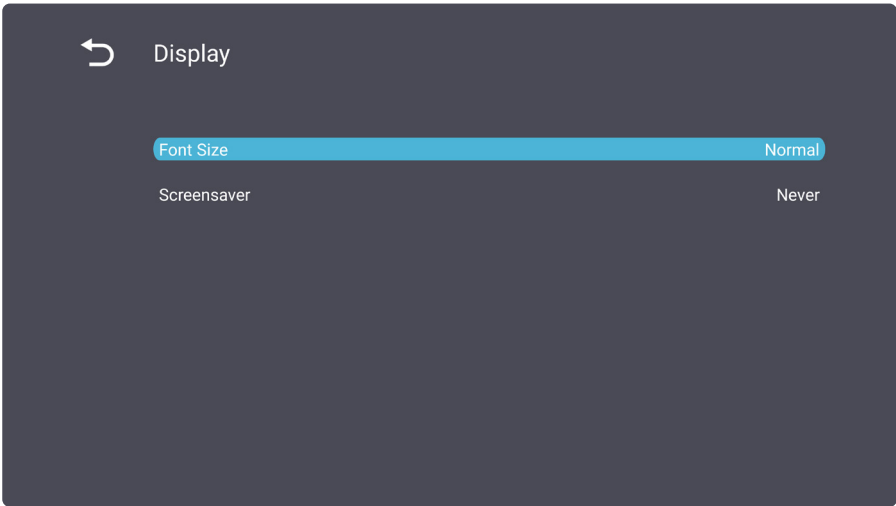
Sub-menu	Description
<p><b>System Tools</b></p>	 <p><u>Clear Storage</u> Clear storage space from both internal and external storage.</p> <p><u>Reset</u> Reset the display to its default factory values.</p> <p><u>Import &amp; Export</u> Import or export the display's settings.</p> <p><u>Clone</u> Copy media files from the display.</p>
<p><b>Display</b></p>	 <p><u>Font Size</u> Set the font size for the display.</p> <p><u>Screensaver</u> Enable or disable a screensaver.</p>

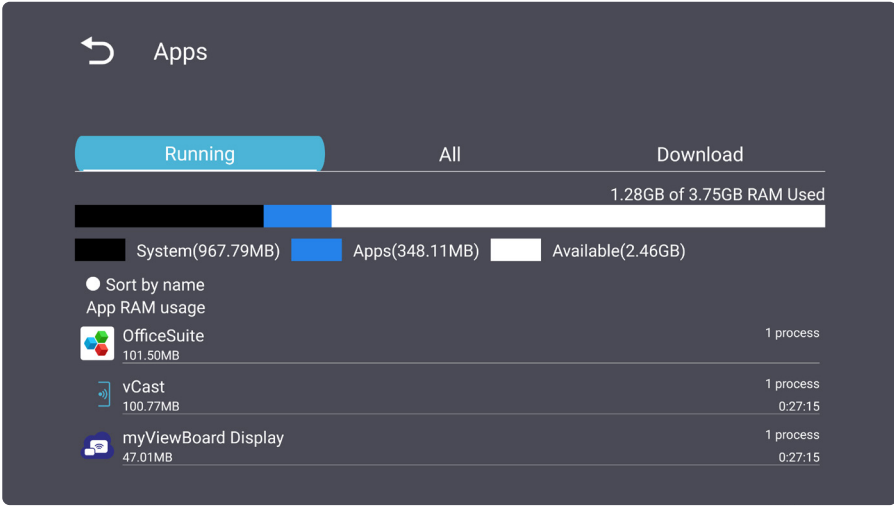
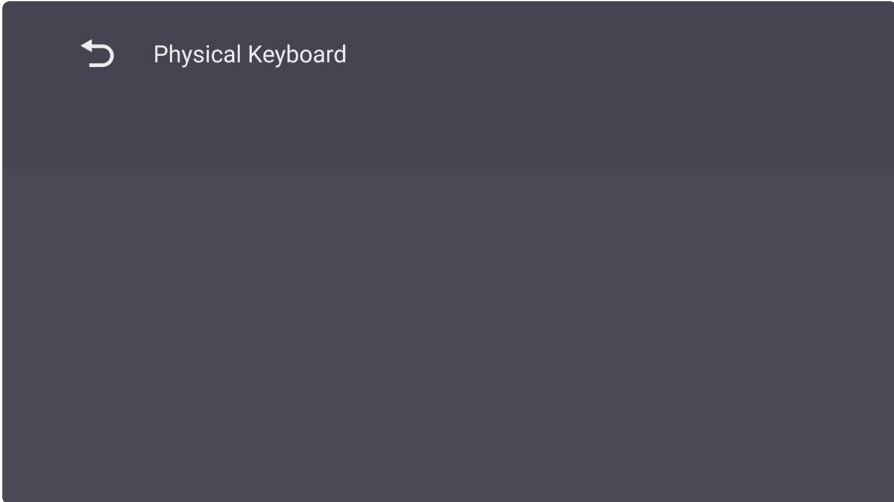

Sub-menu	Description																
<p><b>Apps</b></p>	<p>View information about the display's running, downloaded, or all applications.</p>  <p>The screenshot shows the 'Apps' menu with a back arrow and the title 'Apps'. Below the title are three tabs: 'Running' (selected), 'All', and 'Download'. A progress bar indicates '1.28GB of 3.75GB RAM Used'. Below the bar, a legend shows 'System(967.79MB)' in black, 'Apps(348.11MB)' in blue, and 'Available(2.46GB)' in white. There is a 'Sort by name' option and 'App RAM usage' text. A list of applications is shown with their icons, names, RAM usage, and process counts:</p> <table border="1"> <thead> <tr> <th>App Name</th> <th>RAM Usage</th> <th>Process Count</th> <th>Duration</th> </tr> </thead> <tbody> <tr> <td>OfficeSuite</td> <td>101.50MB</td> <td>1 process</td> <td></td> </tr> <tr> <td>vCast</td> <td>100.77MB</td> <td>1 process</td> <td>0:27:15</td> </tr> <tr> <td>myViewBoard Display</td> <td>47.01MB</td> <td>1 process</td> <td>0:27:15</td> </tr> </tbody> </table>	App Name	RAM Usage	Process Count	Duration	OfficeSuite	101.50MB	1 process		vCast	100.77MB	1 process	0:27:15	myViewBoard Display	47.01MB	1 process	0:27:15
App Name	RAM Usage	Process Count	Duration														
OfficeSuite	101.50MB	1 process															
vCast	100.77MB	1 process	0:27:15														
myViewBoard Display	47.01MB	1 process	0:27:15														
<p><b>Physical Keyboard</b></p>	<p>View and select a keyboard input method.</p>  <p>The screenshot shows the 'Physical Keyboard' menu with a back arrow and the title 'Physical Keyboard'. The rest of the screen is dark and mostly empty.</p>																

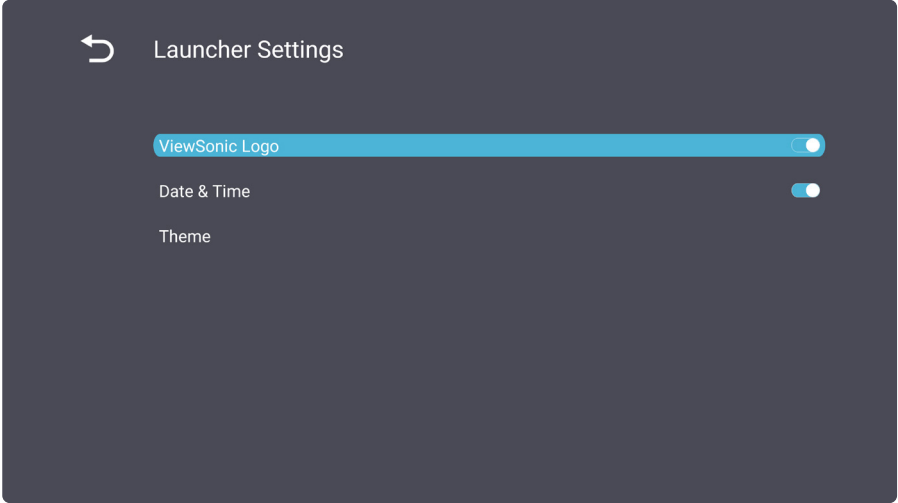
Sub-menu	Description
<p><b>Launcher Settings</b></p>	 <p>The screenshot shows a dark-themed settings menu titled "Launcher Settings" with a back arrow icon. It contains three toggleable options: "ViewSonic Logo" (which is currently turned on), "Date &amp; Time", and "Theme".</p> <p><u>ViewSonic Logo</u> Display or hide the ViewSonic logo on the Home Screen.</p> <p><u>Date &amp; Time</u> Display or hide the Date &amp; Time on the Home Screen.</p> <p><u>Theme</u> Set the theme for the Home Screen.</p>
<p><b>Input Method</b></p>	<p>View and select an input method.</p>

# System

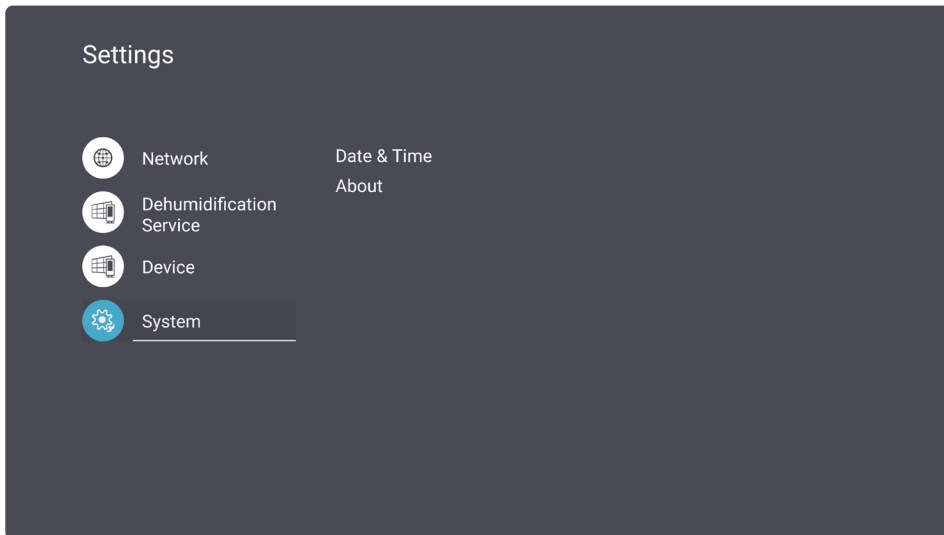

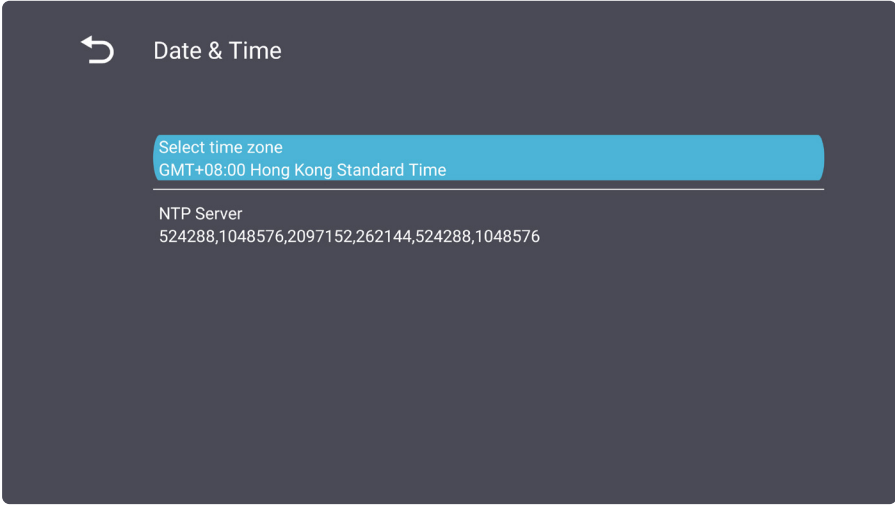
Sub-menu	Description
<p data-bbox="215 1115 411 1153"><b>Date &amp; Time</b></p>	 <p data-bbox="496 1312 738 1346"><u>Select Time Zone</u></p> <p data-bbox="509 1352 895 1388">Set the display's time zone.</p> <p data-bbox="496 1408 655 1442"><u>NTP Server</u></p> <p data-bbox="509 1449 936 1482">View NTP service information.</p>

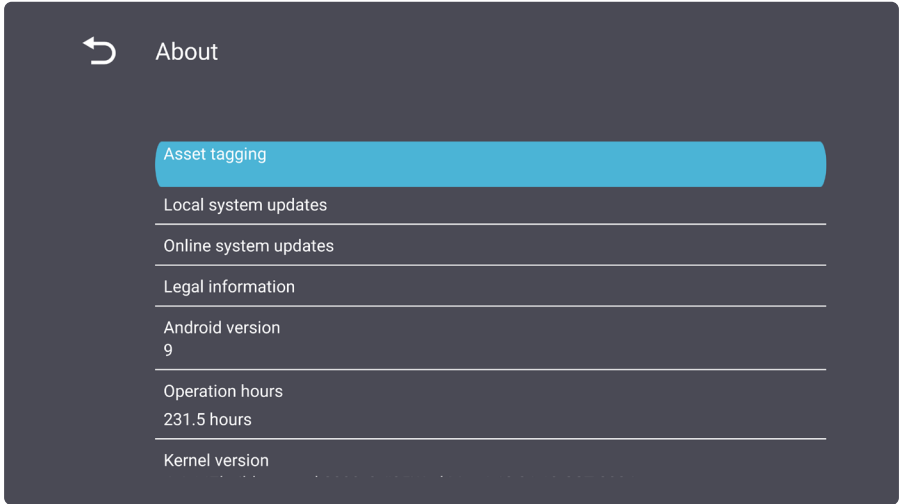
Sub-menu	Description
<b>About Device</b>	<p>View information about the display and update the system locally or online.</p> 

# On-Screen Display (OSD) Menu

Use the On-Screen Display (OSD) Menu to adjust settings.

**NOTE:** The OSD Menu is only available when there is an active input source (e.g., HDMI).

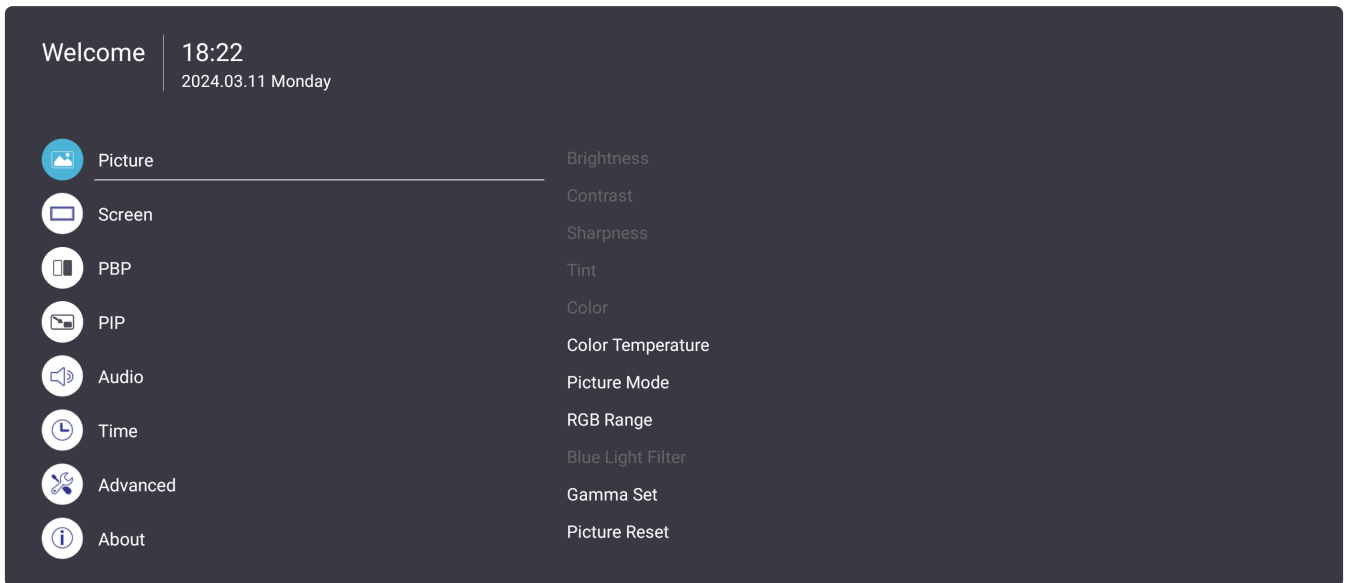

To open and operate the OSD Menu:

1. Press the **MENU** (⚙️) button on the remote control.
2. Press **▼/▲/◀/▶** on the remote control to select menu items or adjust values.
3. Press **OK** to confirm your selection.
4. Press the **RETURN** (↩️) button to go back to the previous menu level.
5. Press the **MENU** (⚙️) button to exit the OSD Menu.

## On-Screen Display (OSD) Menu Tree

Main Menu	Sub-menu	Menu Option	
Picture	Brightness	(-/+, 0~100)	
	Contrast	(-/+, 0~100)	
	Sharpness	(-/+, 0~15)	
	Tint	(-/+, 0~100)	
	Color	(-/+, 0~100)	
	Color Temperature	Warm	
		Normal	
		Cool	
		User	
	Picture Mode	Normal	
		Dynamic	
		Soft	
		User	
	RGB Range	Full Range	
		Limited Range	
		Auto	
Blue Light Filter	(-/+, 0~100)		
Gamma Set	Native		
	2.2		
	2.4		
Picture Reset	Cancel		
	Reset		
Screen	Zoom Mode	Full	
		Real	
		Dynamic	
		21:9	
	Screen Reset	Cancel	
		Reset	

Main Menu	Sub-menu	Menu Option	
<b>PBP</b>	PBP Mode	Full Screen	
		Dual Screen	
		Three-part Screen	
		Center Screen	
		Quad Screen	
	PBP Source		
PBP Audio			
PBP Reset			
<b>PIP</b>	PIP Mode	Top Left	
		Top Right	
		Bottom Left	
		Bottom Right	
	PicMain		
	PicSub		
	PIP Audio		
	PIP Reset		
<b>Audio</b>	Treble	(-/+, 0~24)	
	Bass	(-/+, 0~24)	
	Volume	(-/+, 0~100)	
	Maximum Volume	(-/+, 0~100)	
	Minimum Volume	(-/+, 0~99)	
	Mute	Off	
		On	
	Volume Control	Speaker	
		SPDIF	
		Headset	
Audio Reset	Cancel		
	Reset		

Main Menu	Sub-menu	Menu Option
Time	Off Time	Off
		(10 mins~240 mins)
	Date and Time	Use Network-Provided Time
		Set Date Format
		Choose Time Zone
		Use 24-hour Format
		Schedule List
	Schedule	Enable
		Start Time
		End Time
		Input
		Day of the Week
		Every Week
		Slideshow Interval
	OSD Turn Off	Off
		(5~120 seconds)
	Information OSD	Off
		(1~60 seconds)
	Time Reset	Cancel
		Reset



Main Menu	Sub-menu	Menu Option	
<b>Advanced</b>	Saving	Panel Saving	Off
			On
		Power Save	Sleep
			Hibernate
		Light Sensing	Off
			On
	Boot	Boot On Source	Last Source
			Input
		Boot On Logo	ViewSonic
			Blue
			Black
			Custom
	Signal	Auto Signal Detection	Off
			On
		No Signal Standby	(Off/0 min/5 min/15 min/30 min)
	Port	HDMI with One Wire	Off
			On
		HDMI Version	1.4
			2.0
			Auto
USB Cloning		Import	
		Export	
USB Auto Play		Off	
	On		

Main Menu	Sub-menu	Menu Option	
<b>Advanced</b>	Other	Switch On State	Power Off
			Last Status
			Forced On
		Language	English
			French
			Spanish
			German
			Russian
			Dutch
			Traditional Chinese
			Simplified Chinese
			Turkish
			Arabic
		Factory Reset	Cancel
			Reset
Advanced Reset	Cancel		
	Reset		
<b>About</b>	Heat Status	xx° C / xx° F	
	Monitor Information	Model Name	
		Serial No.	
		Operation Hours	
		SW Version	

# Menu Options

## Picture

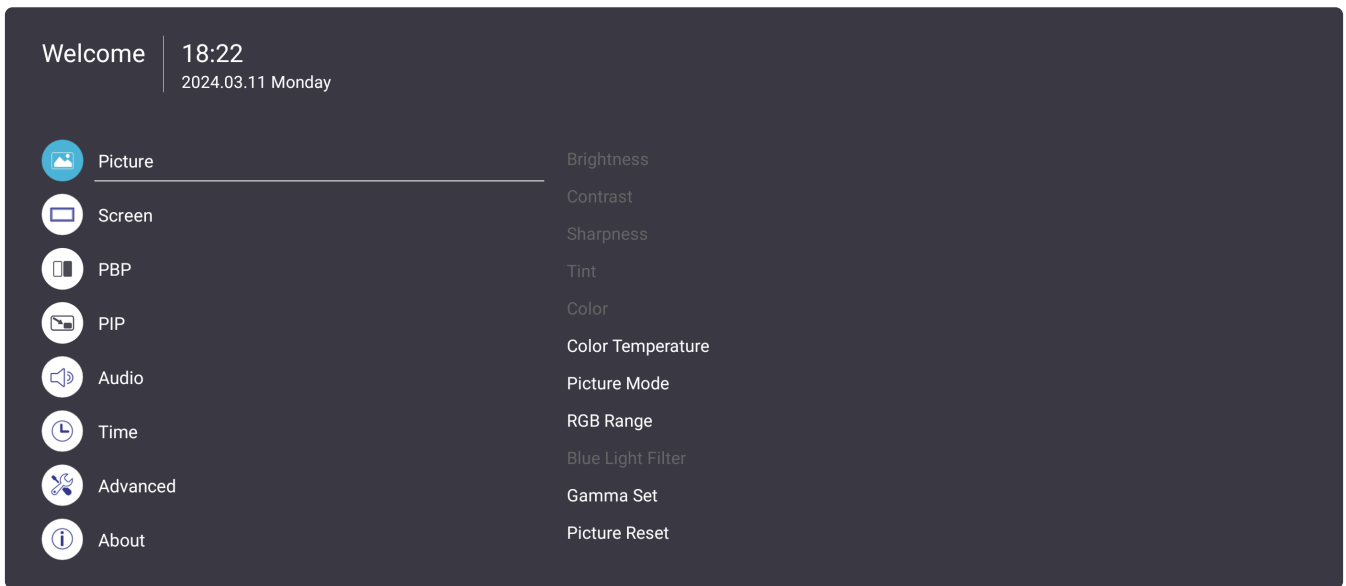

1. Press the **MENU** (⚙️) button on the remote control to display the OSD Menu.
2. Then press **OK** or use **▼/▲/◀/▶** on the remote control to select the **Picture** menu.
3. Press **▼/▲** to select the menu option. Then press **OK** to display its sub-menu, or press **◀/▶** to adjust/select the setting.

**NOTE:** Some sub-menu options may have another sub-menu layer.

Sub-menu	Description
<b>Brightness</b>	Adjust the background black levels of the screen image.
<b>Contrast</b>	Adjust the degree of difference between the lightest and darkest parts of the picture and changes the amount of black and white in the image.
<b>Sharpness</b>	Adjust the on-screen image's clarity.
<b>Tint</b>	Adjust the color balance of the screen image. The higher the value, the more greenish the image becomes. The lower the value, the more reddish the image becomes.
<b>Color</b>	Adjust the amount of color in the on-screen image.
<b>Color Temperature</b>	Set how color appears on screen using the Kelvin scale.
<b>Picture Mode</b>	Select the mode that best fits the display's environment.
<b>RGB Range</b>	Select from Full Range (black and white levels are full [0~255]), Limited Range (Black and white levels are limited [16~235]), or Auto.
<b>Blue Light Filter</b>	Block high-energy blue light for a more comfortable viewing experience.

<b>Sub-menu</b>	<b>Description</b>
<b>Gamma Set</b>	Manually adjust the brightness level of the monitor's grayscale levels.
<b>Picture Reset</b>	Reset the Picture settings to their default values.

## Screen

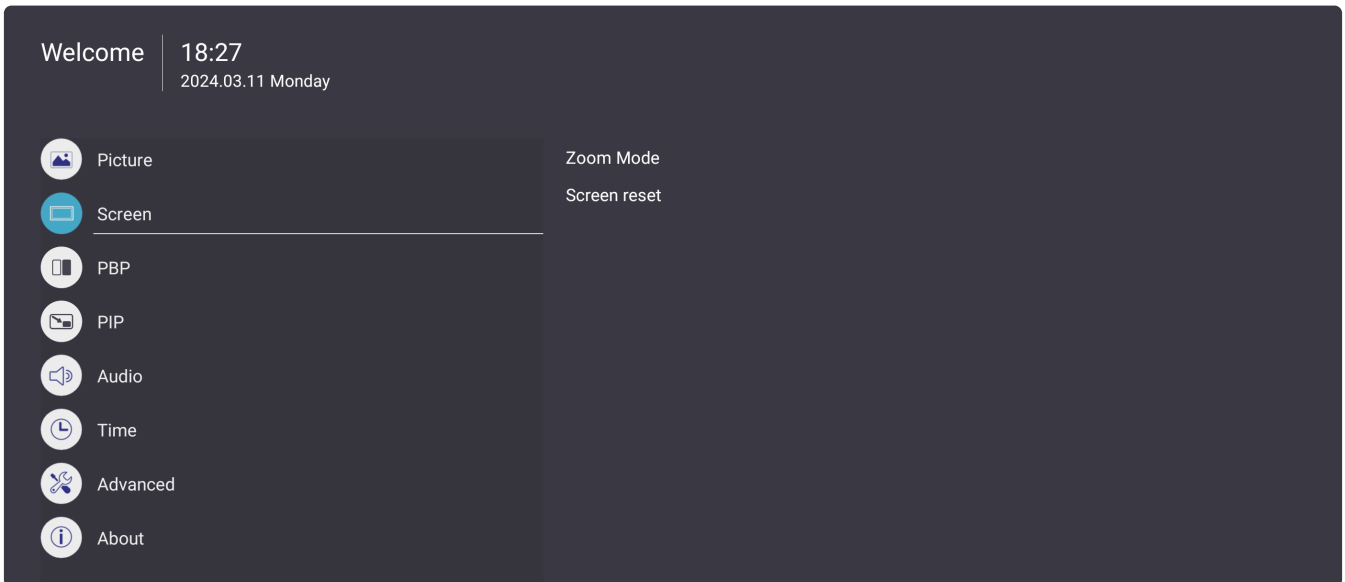

1. Press the **MENU** (⚙️) button on the remote control to display the OSD Menu.
2. Then press **OK** or use **▼/▲/◀/▶** on the remote control to select the **Screen** menu.
3. Press **▼/▲** to select the menu option. Then press **OK** to display its sub-menu, or press **◀/▶** to adjust/select the setting.

**NOTE:** Some sub-menu options may have another sub-menu layer.

Sub-menu	Description
<b>Zoom Mode</b>	Set the on-screen image's width and height.
<b>Screen Reset</b>	Reset the Screen settings to their default values.

# PBP (Picture-by-Picture)

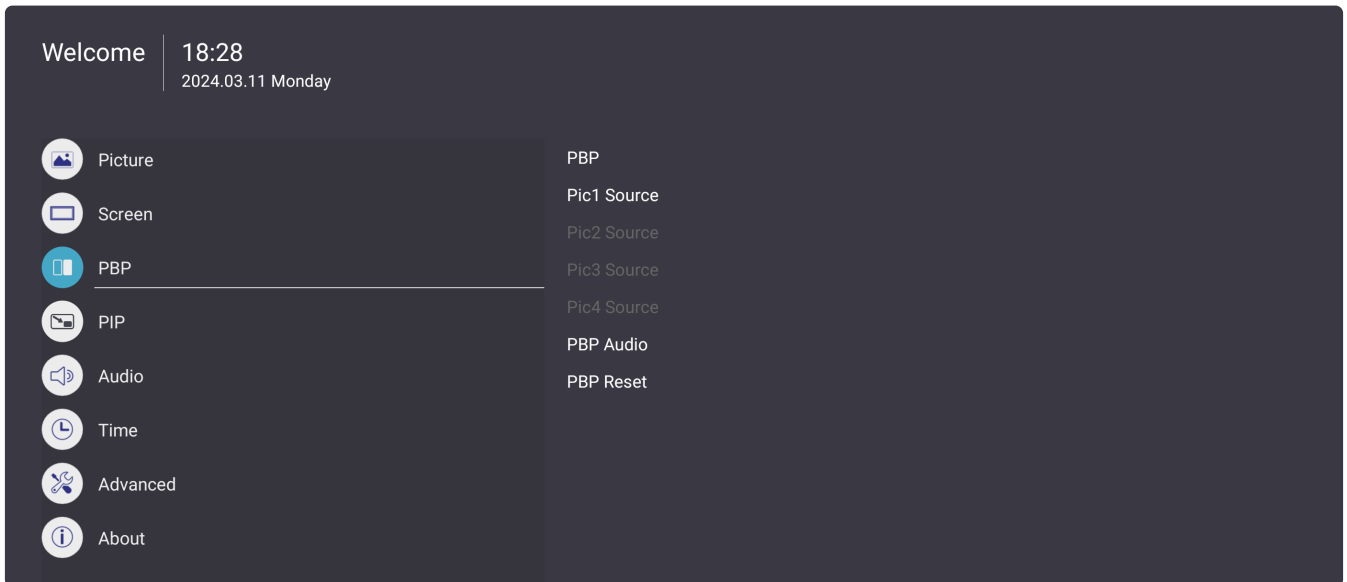

1. Press the **MENU** (⚙️) button on the remote control to display the OSD Menu.
2. Then press **OK** or use **▼/▲/◀/▶** on the remote control to select the **PBP** menu.
3. Press **▼/▲** to select the menu option. Then press **OK** to display its sub-menu, or press **◀/▶** to adjust/select the setting.

**NOTE:** Some sub-menu options may have another sub-menu layer.

Sub-menu	Description
<b>PBP Mode</b>	Select the type of PBP screen: Full, Dual, Three-part, Center, or Quad.
<b>PBP Source</b>	Set the video source for the PBP.
<b>PBP Audio</b>	Set the audio source for the PBP.
<b>PBP Reset</b>	Reset the PBP settings to their default values.

# PIP (Picture-in-Picture)

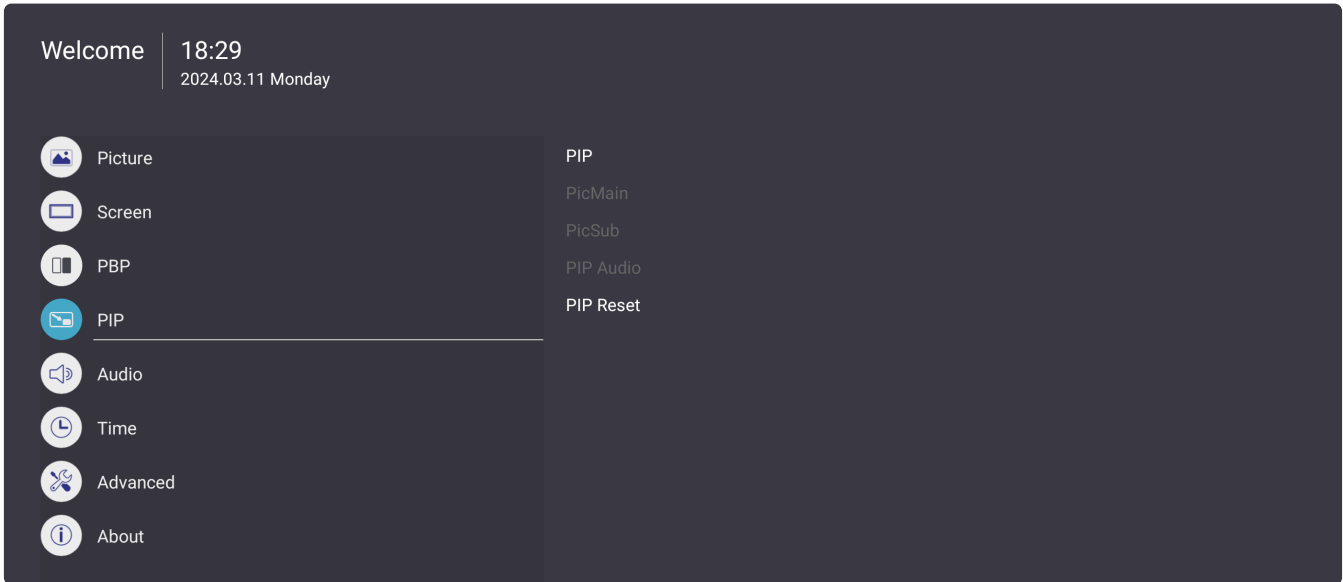

1. Press the **MENU** (⚙️) button on the remote control to display the OSD Menu.
2. Then press **OK** or use **▼/▲/◀/▶** on the remote control to select the **PIP** menu.
3. Press **▼/▲** to select the menu option. Then press **OK** to display its sub-menu, or press **◀/▶** to adjust/select the setting.

**NOTE:** Some sub-menu options may have another sub-menu layer.

Sub-menu	Description
<b>PIP Mode</b>	Select the location of the PIP screen: Top Left, Top Right, Bottom Left, Bottom Right.
<b>PicMain</b>	Set the video input source of the main screen.
<b>PicSub</b>	Set the video input source of the sub-screen.
<b>PIP Audio</b>	Set the audio source for the PIP.
<b>PIP Reset</b>	Reset the PIP settings to their default values.

## Audio

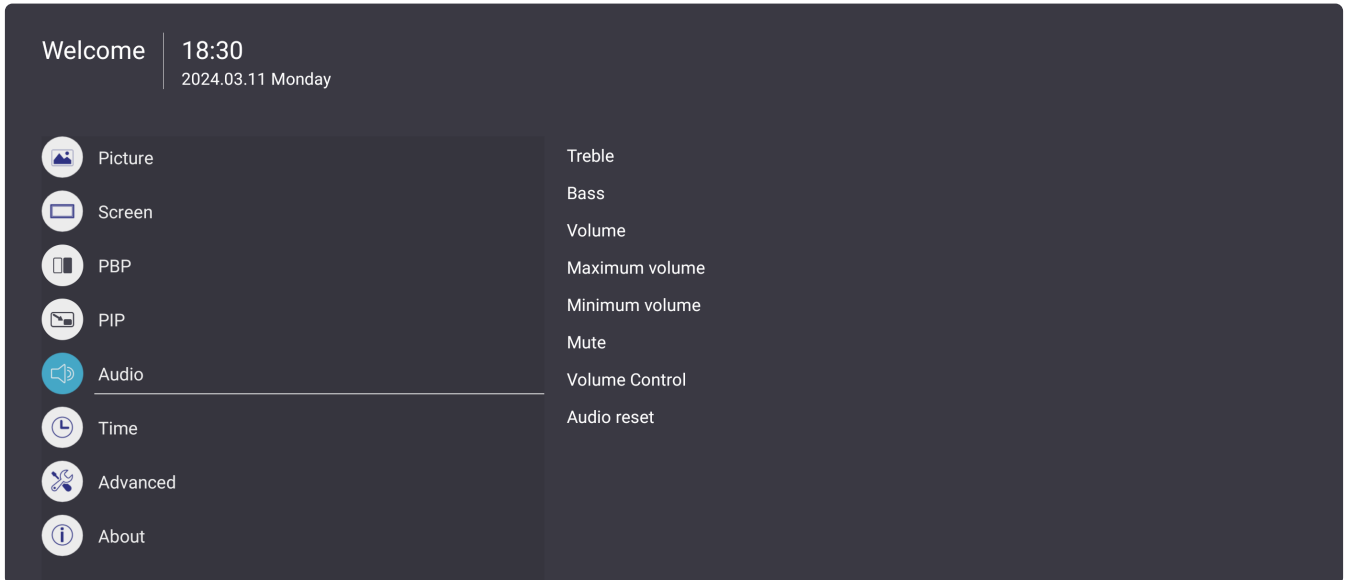

1. Press the **MENU** (⚙️) button on the remote control to display the OSD Menu.
2. Then press **OK** or use **▼/▲/◀/▶** on the remote control to select the **Audio** menu.
3. Press **▼/▲** to select the menu option. Then press **OK** to display its sub-menu, or press **◀/▶** to adjust/select the setting.

**NOTE:** Some sub-menu options may have another sub-menu layer.

Sub-menu	Description
<b>Treble</b>	Adjust the display's treble level (higher-pitched sounds).
<b>Bass</b>	Adjust the display's bass level (lower-pitched sounds).
<b>Volume</b>	Adjust the display's sound level.
<b>Maximum Volume</b>	Set a maximum sound level.
<b>Minimum Volume</b>	Set a minimum sound level.
<b>Mute</b>	Turn off the display's sound.
<b>Volume Control</b>	Select the audio source: the display's Speaker, SPDIF port, or Audio Out port.
<b>Audio Reset</b>	Reset the Audio settings to their default values.



# Time

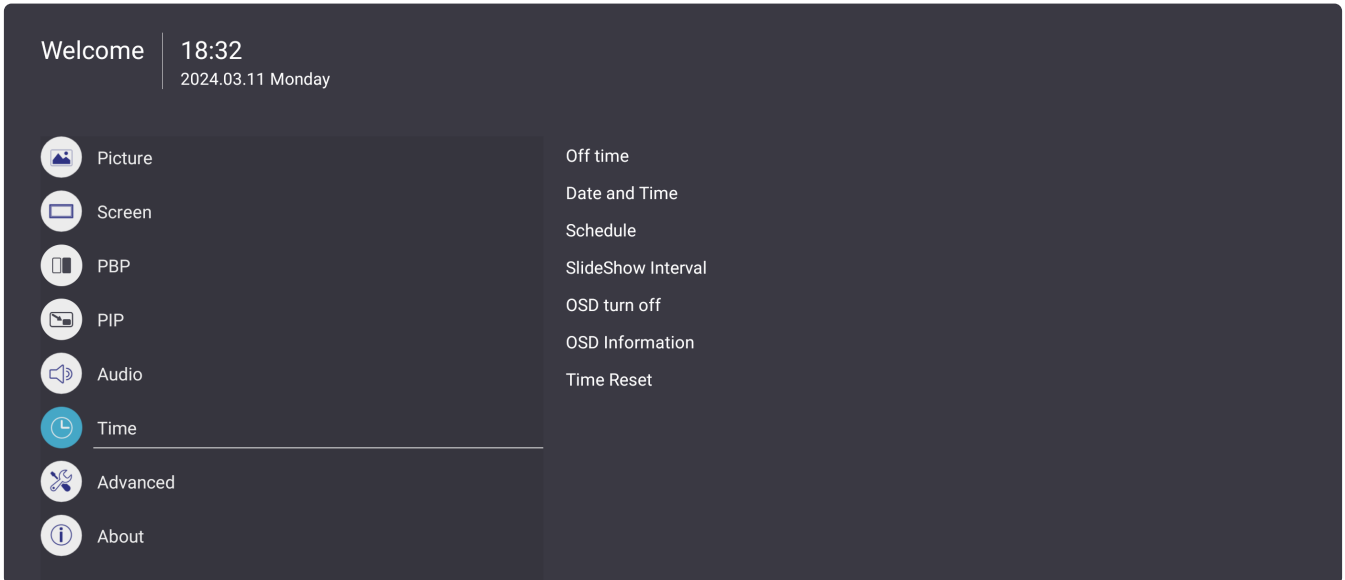

1. Press the **MENU** (⚙️) button on the remote control to display the OSD Menu.
2. Then press **OK** or use **▼/▲/◀/▶** on the remote control to select the **Time** menu.
3. Press **▼/▲** to select the menu option. Then press **OK** to display its sub-menu, or press **◀/▶** to adjust/select the setting.

**NOTE:** Some sub-menu options may have another sub-menu layer.

Sub-menu	Description
<b>Off Time</b>	Set a time for the display to turn off.
<b>Date and Time</b>	Set the date and time of the display.
<b>Schedule</b>	Set a schedule to turn the display on and off.
<b>Slideshow Interval</b>	Set the time interval to change between images for a photo slide show.
<b>OSD Turn Off</b>	Set the length of time the OSD Menu remains on screen.
<b>OSD Information</b>	Set the length of time the volume, brightness, and input source menu remain on screen.
<b>Time Reset</b>	Reset the Time settings to their default values.

# Advanced



1. Press the **MENU** (⚙️) button on the remote control to display the OSD Menu.
2. Then press **OK** or use **▼/▲/◀/▶** on the remote control to select the **Advanced** menu.
3. Press **▼/▲** to select the menu option. Then press **OK** to display its sub-menu, or press **◀/▶** to adjust/select the setting.

**NOTE:** Some sub-menu options may have another sub-menu layer.

Sub-menu	Description
<b>Saving</b>	<p><u>Panel Saving</u> Reduces the risk of image burn-in when enabled.</p> <p><u>Power Save</u> Reduce power consumption.</p>
<b>Boot</b>	<p><u>Boot On Source</u> Select the input source to enter automatically after the display is turned on.</p> <p><u>Boot On Logo</u> Show or hide a logo when the display is turned on.</p>

Sub-menu	Description
<p><b>Signal</b></p>	<p><u>Auto Signal Detection</u> Allow the display to detect and display available input sources automatically.</p> <p><u>No Signal Standby</u> Set the time period for the display to enter standby mode when there is no input signal.</p>
<p><b>Port</b></p>	<p><u>HDMI with One Wire</u> Enable or disable CEC (Consumer Electronics Control). CEC synchronizes power on/off operation via HDMI connection. That is, if a device that also supports CEC is connected to the HDMI input of the display, when the display's power is turned off, the power of the connected device will also be turned off automatically. When the power of the connected device is turned on, the display's power will be turned on automatically.</p> <p><u>USB Cloning</u> Save the OSD Menu configuration to a USB storage device.</p> <p><u>HDMI Version</u> Select the HDMI version.</p> <p><u>USB Auto Play</u> If enabled, the display will copy media files from a connected external USB storage device to the display's internal storage then play the media files automatically. <b>NOTE:</b> If power is lost during the file transfer, please remove the files from the internal storage and try again.</p>
<p><b>Other</b></p>	<p><u>Switch On State</u> Select the display status for the next time the power cord is connected to a power outlet: Power Off, the display will remain off, Last Status, the display will return to the previous power status, or Forced On, the display will turn on.</p> <p><u>Language</u> Set the language for the OSD Menu.</p> <p><u>Factory Reset</u> Reset all OSD Menu settings to their default values.</p> <p><u>Advanced Reset</u> Reset the Advanced settings to their default values.</p>

## About

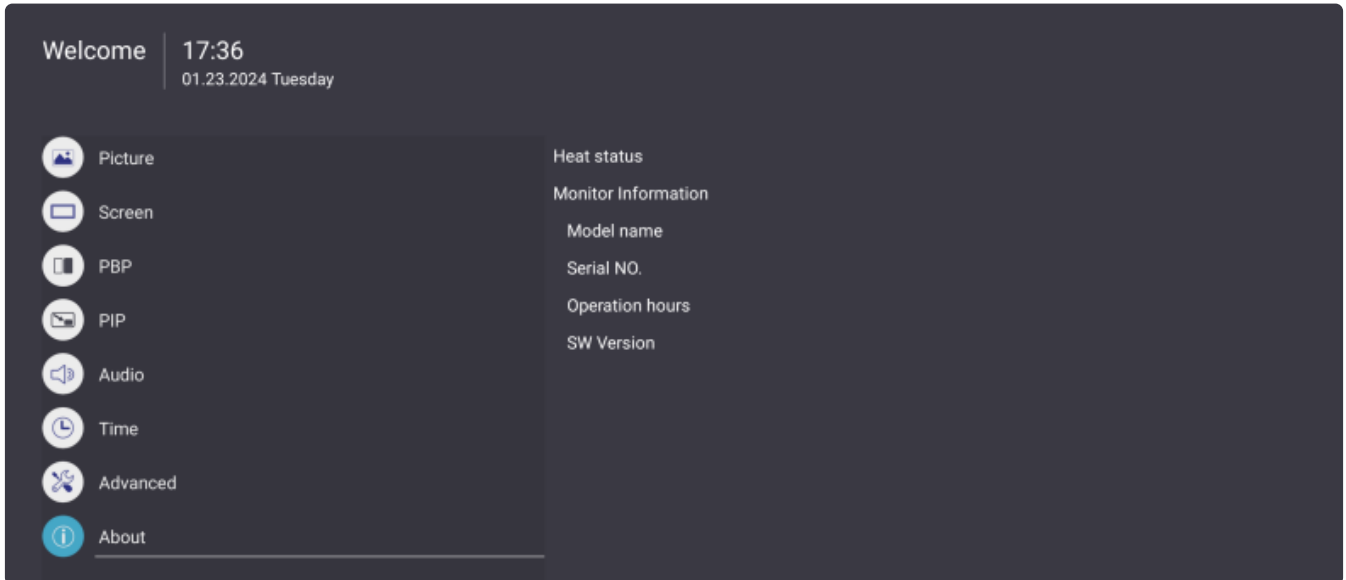

1. Press the **MENU** (⚙️) button on the remote control to display the OSD Menu.
2. Then press **OK** or use **▼/▲/◀/▶** on the remote control to select the **About** menu.
3. Press **▼/▲** to select the menu option. Then press **OK** to display its sub-menu, or press **◀/▶** to adjust/select the setting.

**NOTE:** Some sub-menu options may have another sub-menu layer.

Sub-menu	Description
Heat Status	View the maximum temperature of the display.
Monitor Information	View information about the display such as: Model Name, Serial Number, Operation Hours, and Software Version.

# Pre-installed Applications

## vCast

Working with ViewBoard® Cast software (vCast, vCast Pro, and vCastSender), the vCast application will allow the display to receive laptop screens (Windows/Mac/Chrome) and mobile (iOS/Android) users' screens, photos, videos, annotations, and camera(s) that are using the vCastSender application.

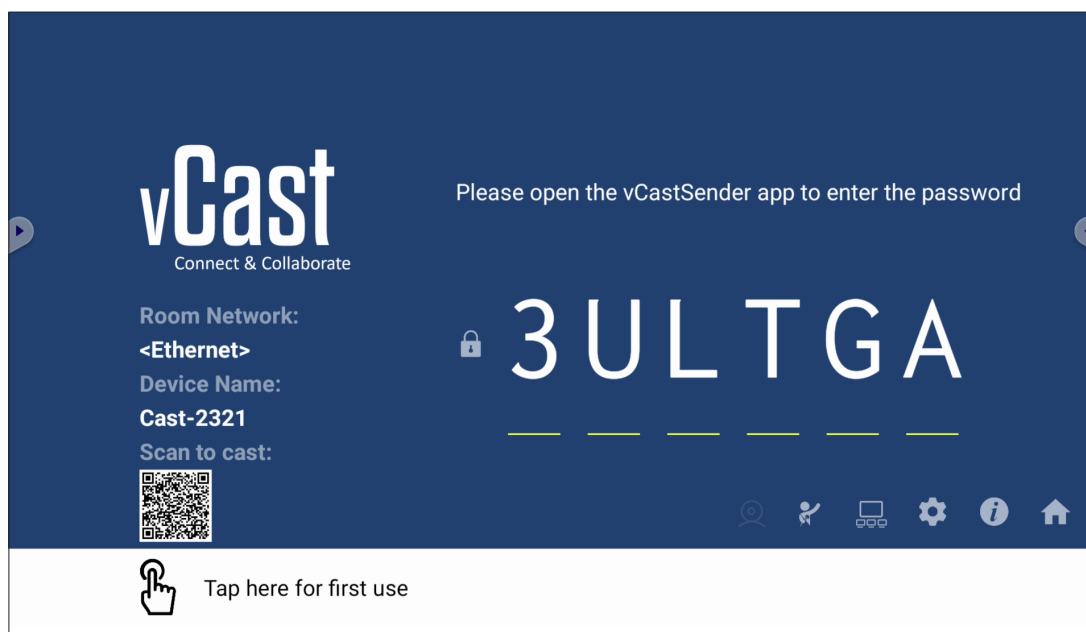

## Network Information

- ViewBoard® Cast software, laptops, and mobile devices can connect to both the same subnet and cross subnet by entering the on-screen PIN code.
- Connected devices will show up under **Device List** on the same subnet connection.
- If the device does not show up under **Device List**, users will need to key-in the on-screen PIN code.
- **Ports:**
  - » TCP 56789, 25123, 8121 & 8000 (Controlling message port & client device audio transfer)
  - » TCP 8600 (BYOM)
  - » TCP 53000 (Request share screen)
  - » TCP 52020 (Reverse control)
  - » TCP 52025 (Reverse control for ViewBoard Cast Button)
  - » TCP 52030 (Status sync)
  - » TCP 52040 (Moderator mode)
  - » UDP 48689, 25123 (Device searching and broadcast & client device audio transfer)
  - » UDP 5353 (Multicast search device protocol)
- **Port and DNS for Activation:**
  - » Port: 443
  - » DNS: <https://vcastactivate.viewsonic.com>
- **OTA Service**
  - » Server Port: TCP 443
  - » Server FQDN Name: <https://vcastupdate.viewsonic.com>

## Display Group Settings

To adjust the Display Group Settings, select the Display Group icon () located in the lower-right corner of the screen.

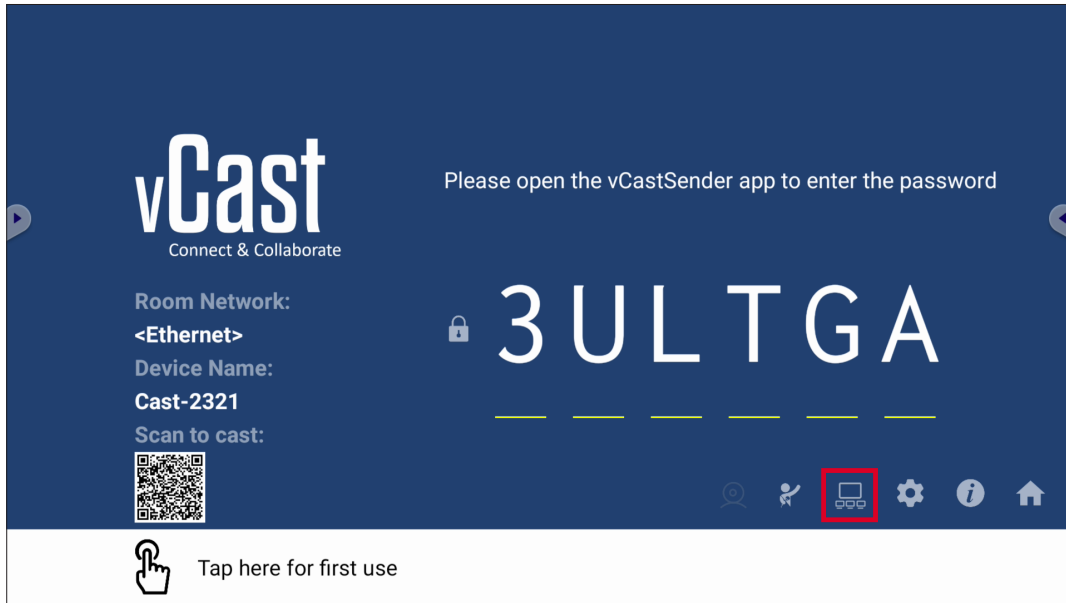

1. Toggle the “Turn On/Off Display Group” ON to enable the Display Group feature.

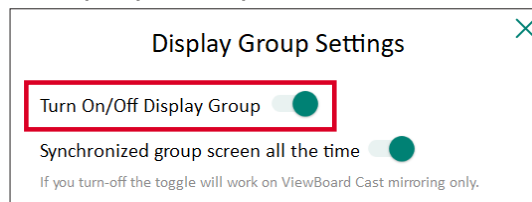

**NOTE:** Other preinstalled ViewBoard Cast devices in the same network will be listed.

2. Select the devices you want to join the display group and select **OK** to save the settings.

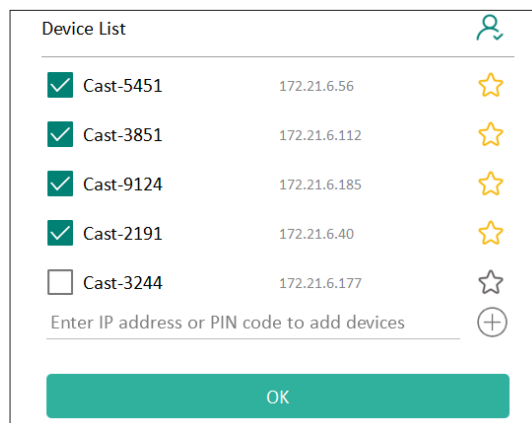

**NOTE:**

- If the devices you want to group are not listed, you can enter their respective IP address or connecting PIN code.
- The Display Group maximum device limit is six devices.

3. If you frequently connect to the same device, you can select the Star icon (★) next to the device to add it to your frequently connected devices list, “My List of Devices in Group”, for easier Display Group setup and management.

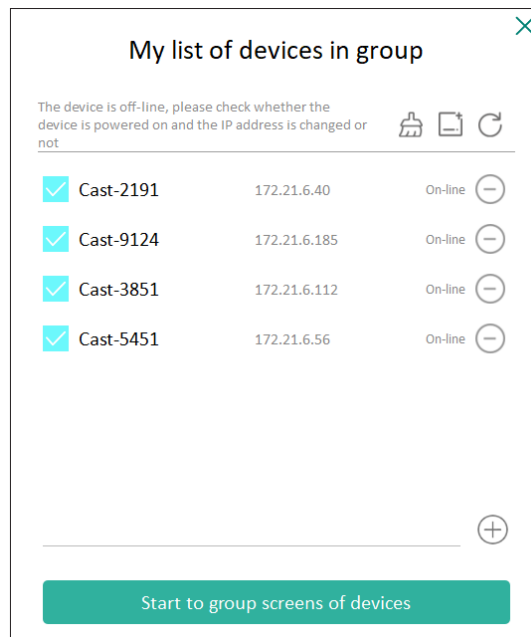



## Synchronized Group Screen All the Time

When the “Synchronized group screen all the time” function is toggled ON, it will display a synchronized group screen continuously. If it is toggled OFF, it will work on vCast mirroring only.

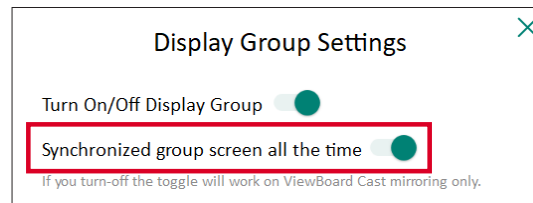

**NOTE:** Select the devices to group first, then toggle the “Synchronized group screen all the time” function ON to avoid interruption.

## Share a Screen to the Display Group (One to Many Casting)

After confirming the above settings, you can share your screen to the main display, then the grouped client devices will be synced up to your screen.



## Moderator Mode

Moderator Mode allows the moderator to take control of the devices connected to the display. To enter Moderator Mode, select the Moderator Mode icon (👤) located in the lower-right corner of the screen.

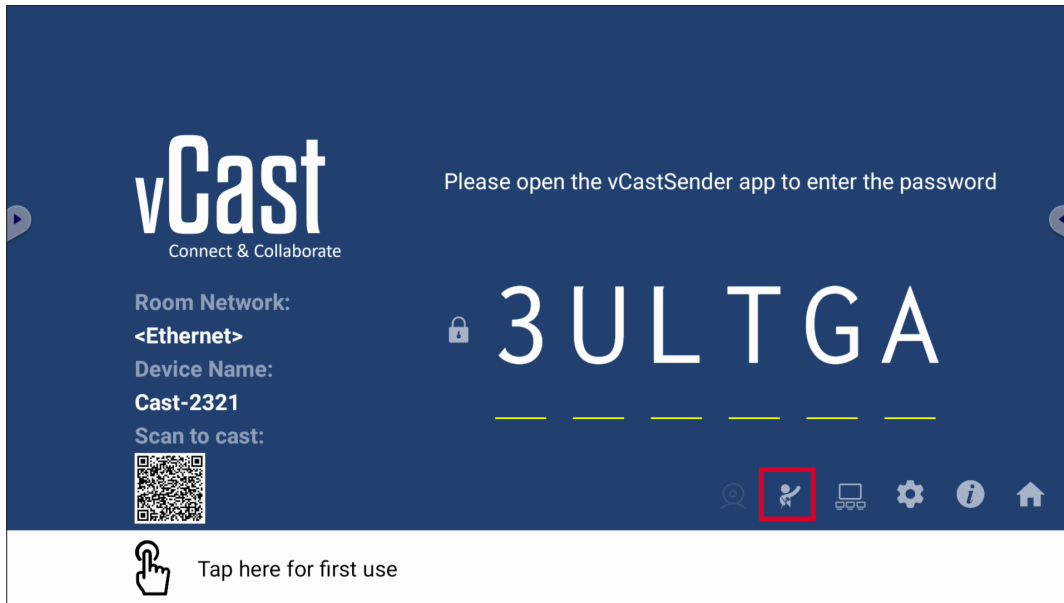

When enabled, the moderator can view a list of all connected screens in the left floating window and can preview each participant's screen and then select any of participant's screen and cast to the display's main screen for presentation. The moderator can also control each participant's screen, annotate on the display, and remove unwanted participants by selecting the close icon (X).

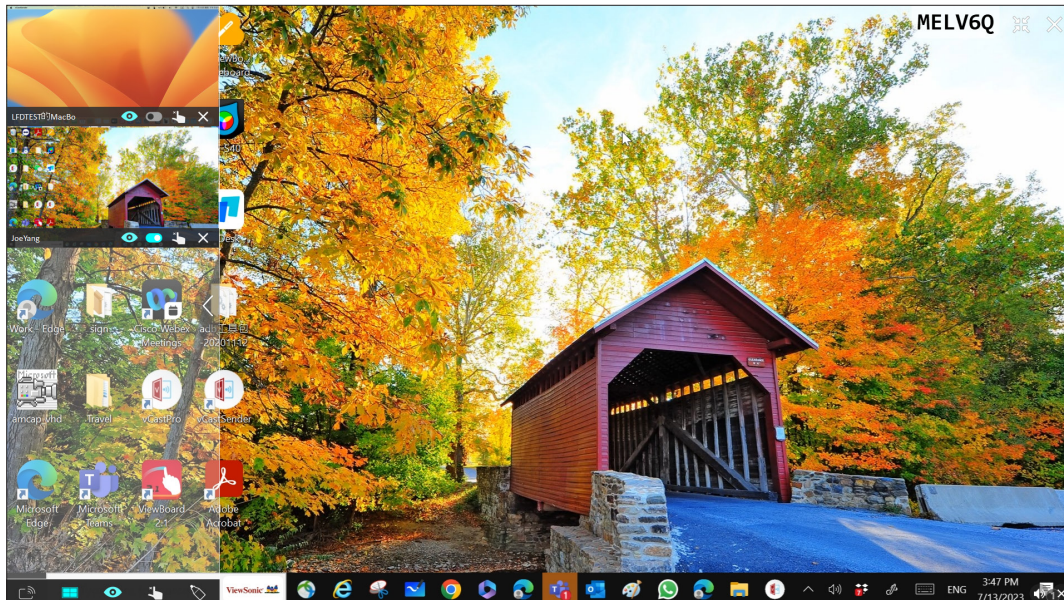

## Broadcast

When enabled, the display's screen will be broadcasted to all of the participant's connected screens simultaneously. The participants can only view the presentation contents until the moderator disables the Broadcast function.

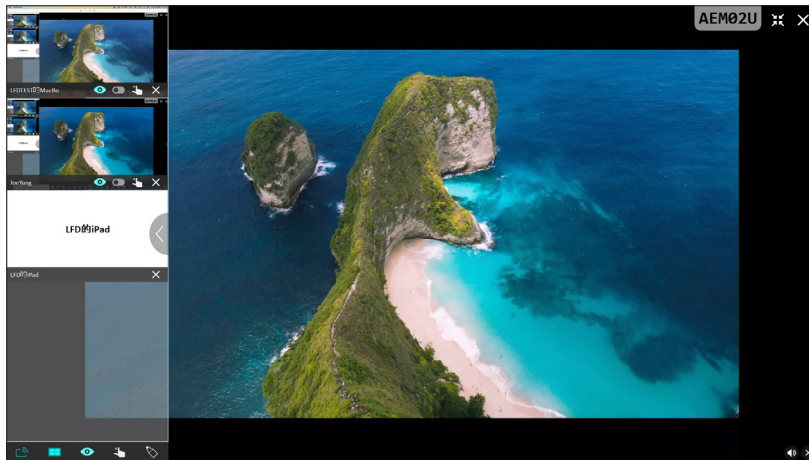

## Multiple Screen Sharing

By default, vCast is set to allow multiple screen sharing, but can also be set to single screen sharing. To do this, the moderator can select the Multiple Screen Sharing icon to switch to single screen sharing.

## Preview Screen

By default, vCast is set to let the moderator preview the participant's screen contents prior to sharing to the display. Selecting the Preview Screen icon, the Moderator can switch to see the participant's name only.

## Touch

By default, participants can use touch for collaboration after connecting. The moderator can enable/disable the touch function of a participant by selecting the Touch icon in their window.

### NOTE:

- Moderator Mode is supported on all vCastSender and AirPlay devices, but mobile devices are limited to a “preview” function. Additionally, mobile Android devices cannot cast sound out.
- When you cast your Windows/Mac/Chrome screen to the display, the selected full screen unit will not be broadcasted back to your device to avoid repetitive screen casting.
- The active presenter can touch each of the participant's screens to remotely control casting devices.
- The number of multi-screen presenters on-screen depends on your Windows CPU processor performance and router specifications.

## Casting from Windows, MacBook, and Chrome Devices

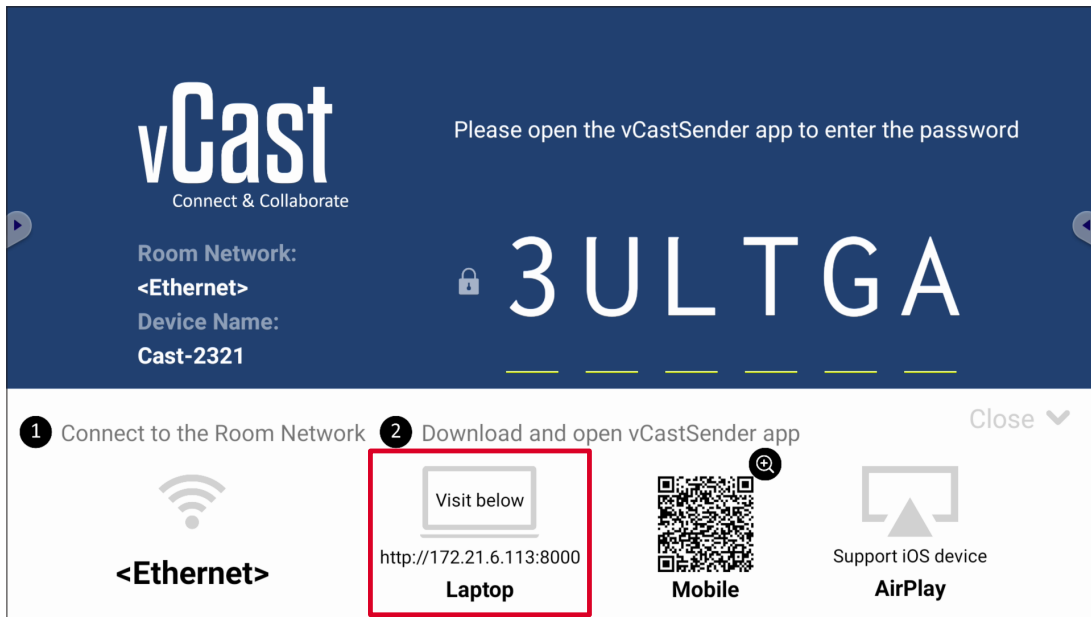

1. Ensure the client device (e.g., laptop) is connected to the same network as the display.

**NOTE:** The network name can be found under **Room Network**.

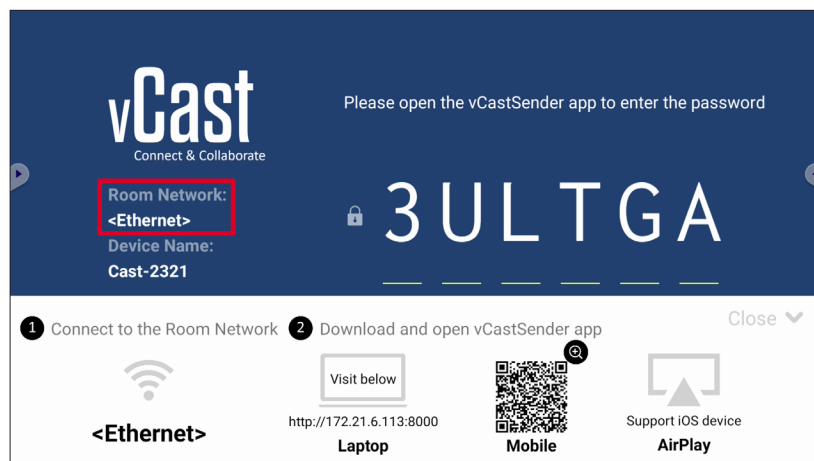

2. On the client device, visit the address that is shown on the display to download and install the vCastSender application.
3. After installing, launch the vCastSender application.

4. To connect to the display, input the PIN code and click OK.

**NOTE:** The PIN code can be found as highlighted below:

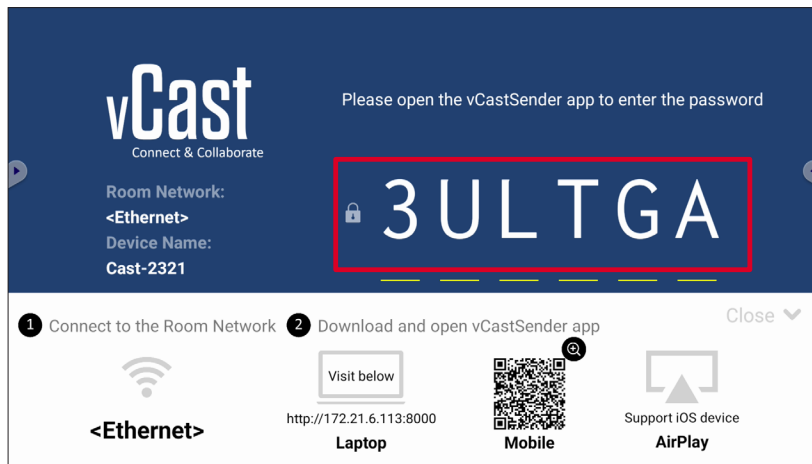

5. Additionally, you can connect to the display by clicking **Device List** then the **Device Name** listed.

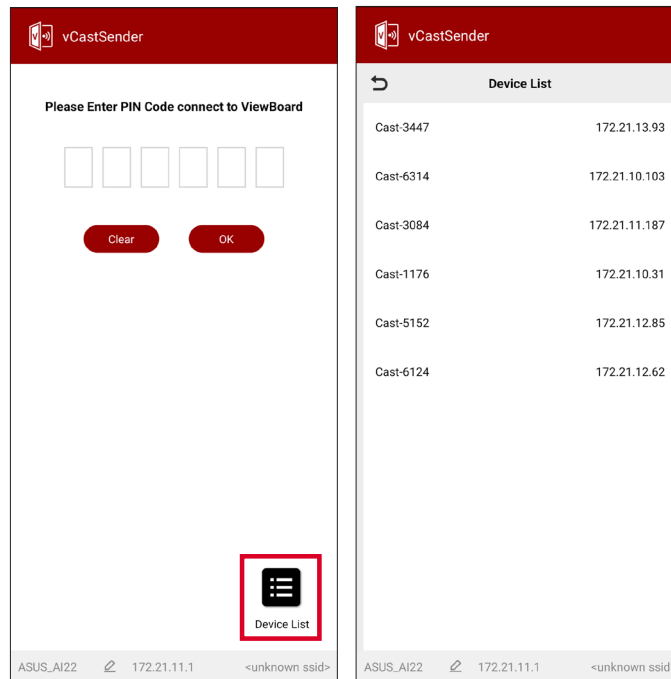

**NOTE:** The **Device Name** can be found as highlighted below:

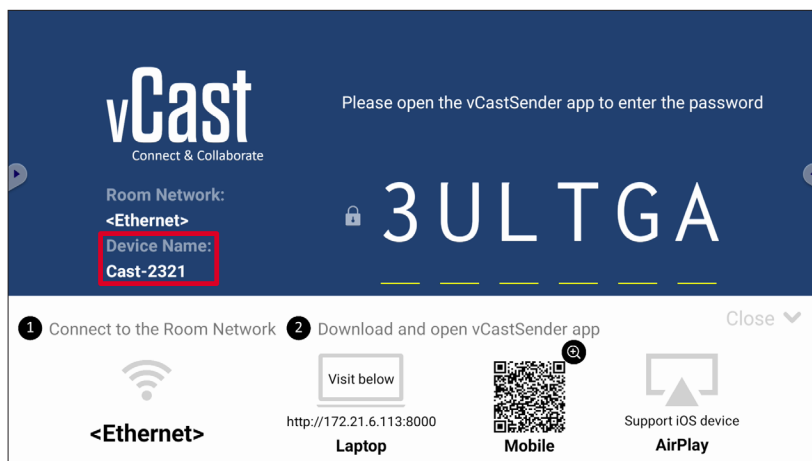

## Casting from Android Devices

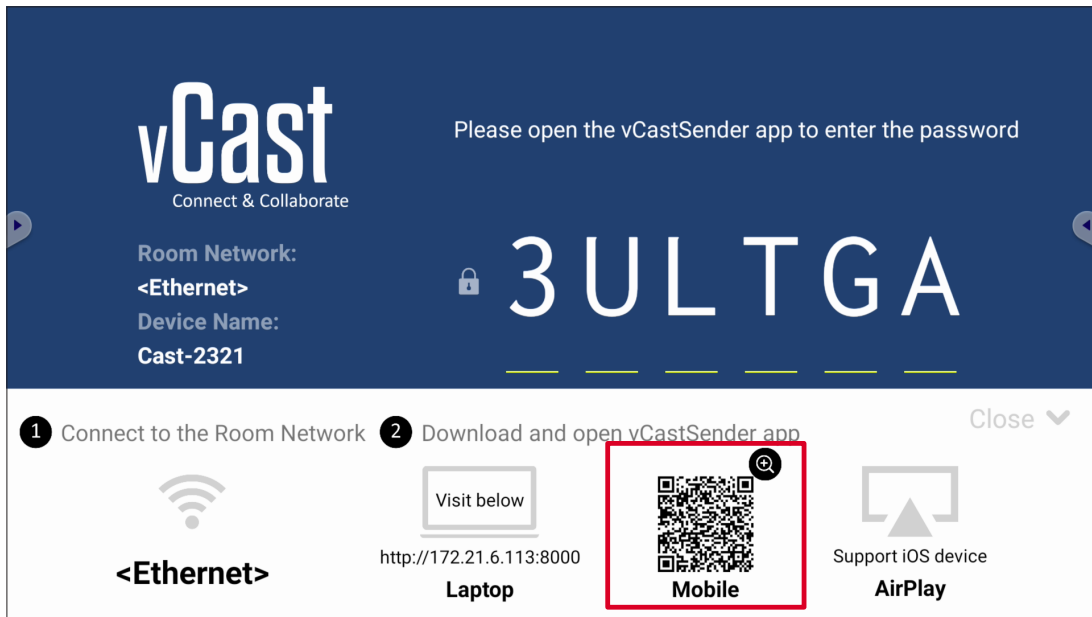

1. Ensure the client device (e.g., Android phone or tablet) is connected to the same network as the display.

**NOTE:** The network name can be found under **Room Network**.

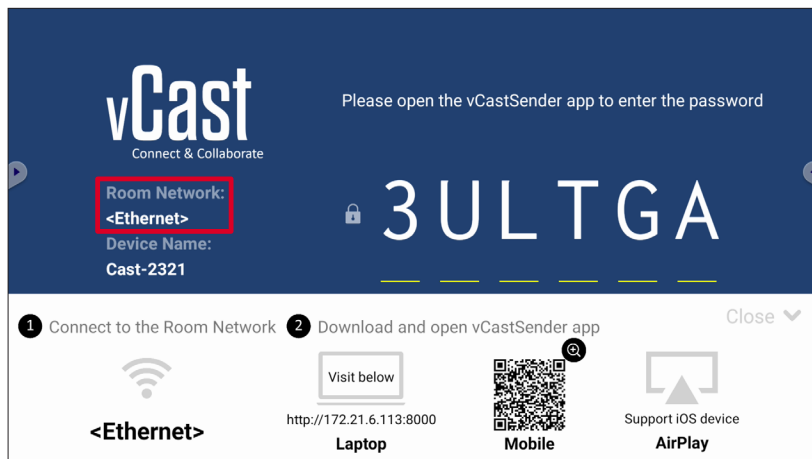



2. On the Android client device, scan the QR code shown on the display to directly download the vCastSender application, or download the application from the Google Play Store.

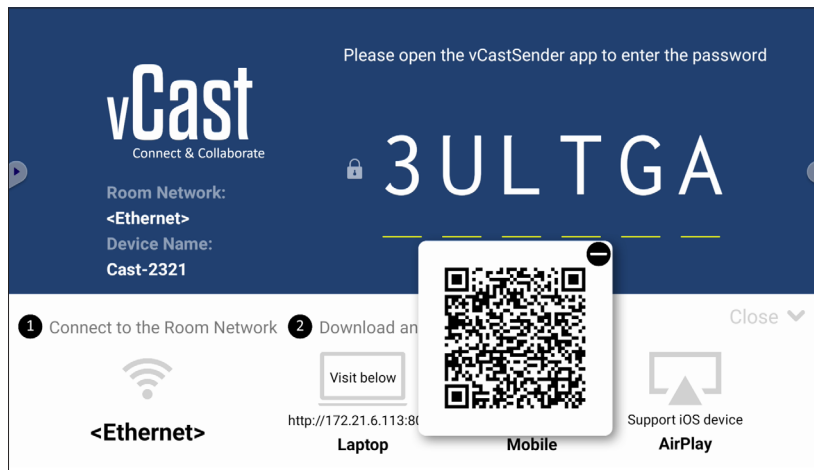

3. After installing, launch the vCastSender application.
4. To connect to the display, input the PIN code and select **OK**.

**NOTE:** The **PIN code** can be found as highlighted below:

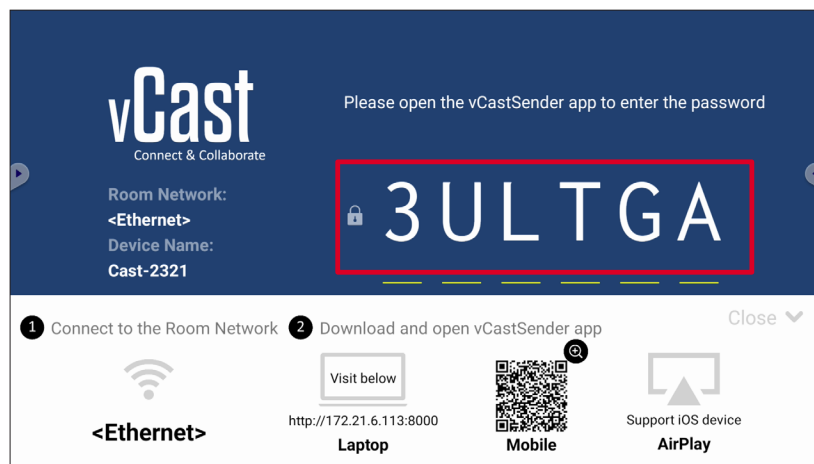

5. You can also connect to the display by selecting **Device List** then the **Device Name** listed.

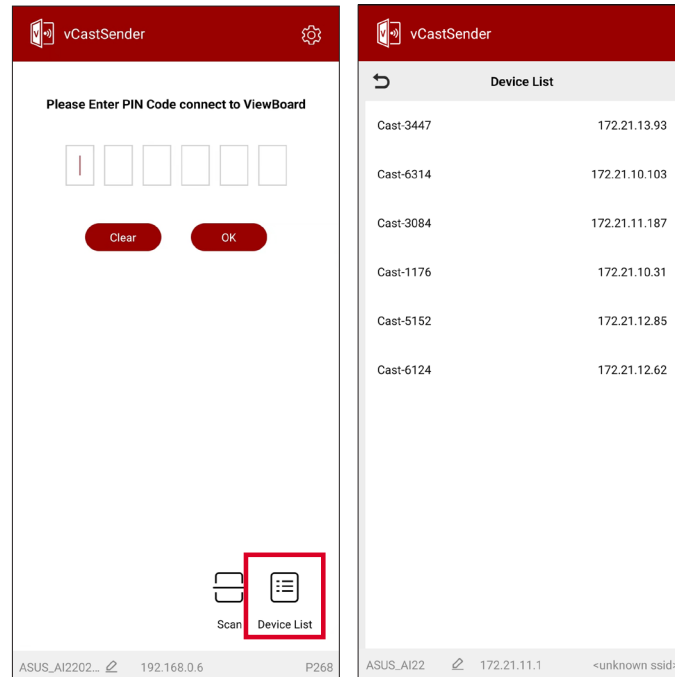

**NOTE:** The **Device Name** can be found as highlighted below:

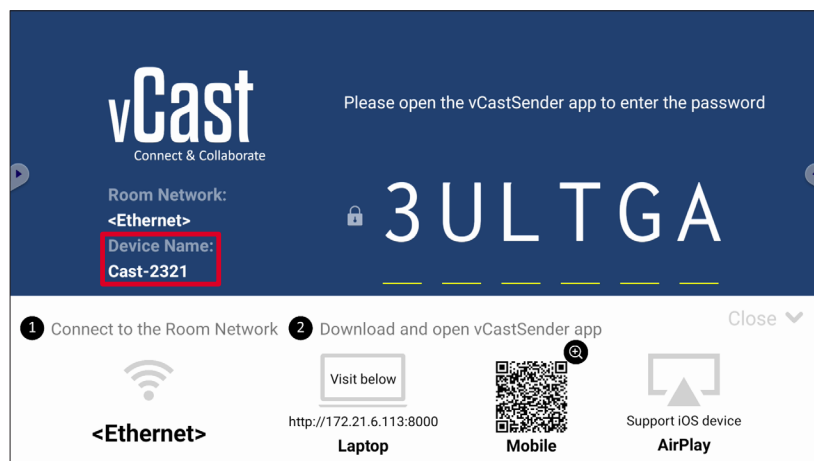



6. Additionally, you can connect to the display by selecting **Scan** then placing the on-screen QR code into the box to automatically connect.

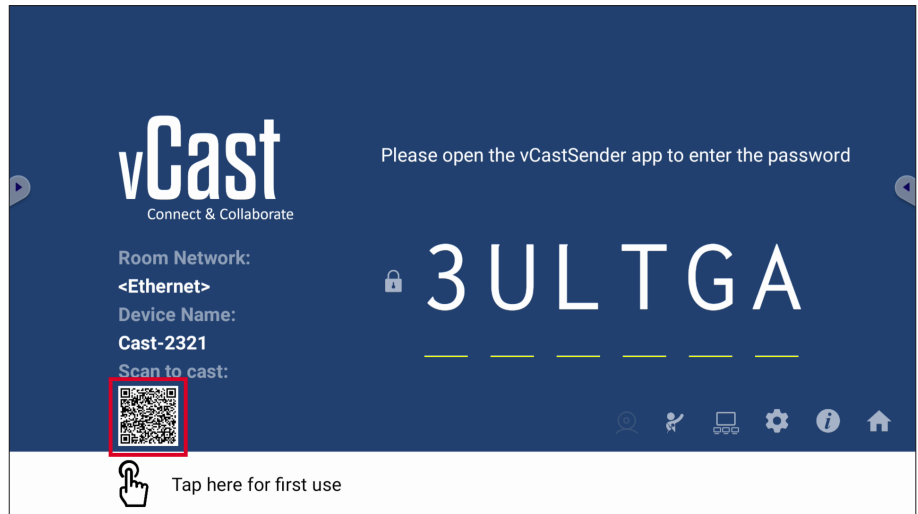
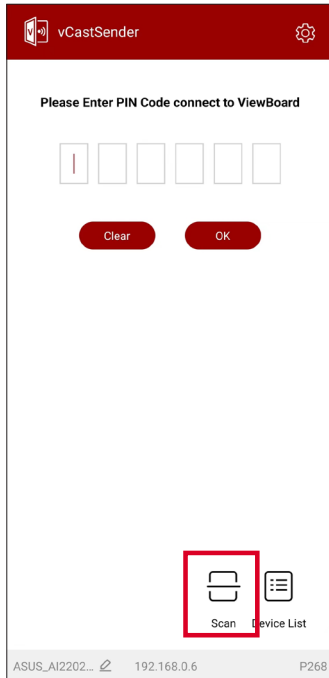

## Casting from Apple iOS Devices

Apple AirPlay® is compatible with vCast for screen mirroring and content streaming under the same subnet environment only. An “AirPlay Password” will be generated on-screen for connection when using AirPlay to cast to the display.

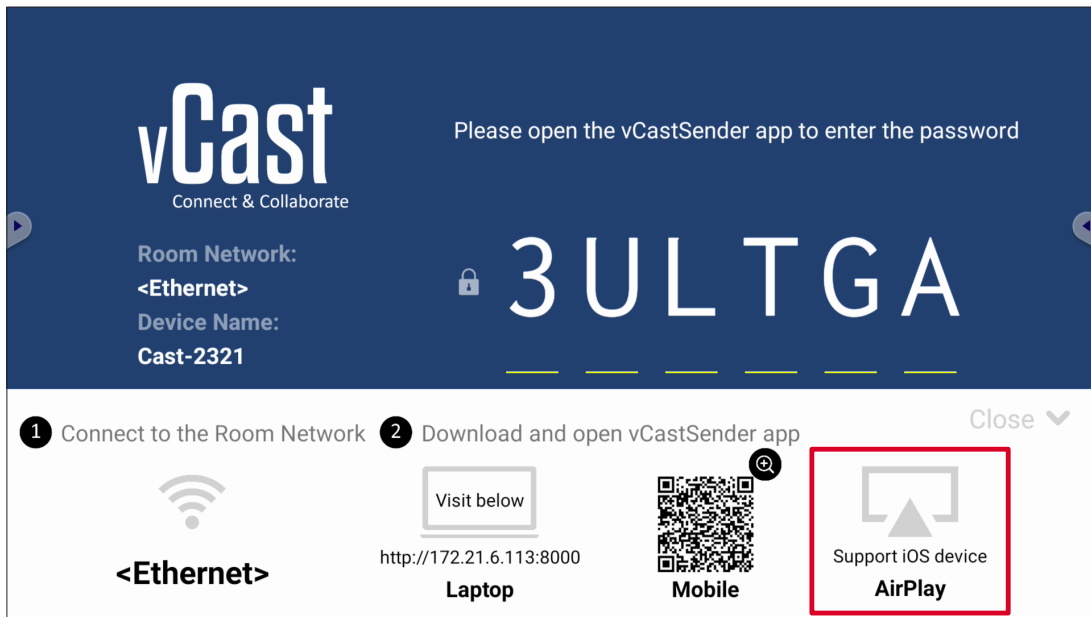

1. Ensure the client device (e.g., iPhone or iPad) is connected to the same network as the display.

**NOTE:** The network name can be found under **Room Network**.

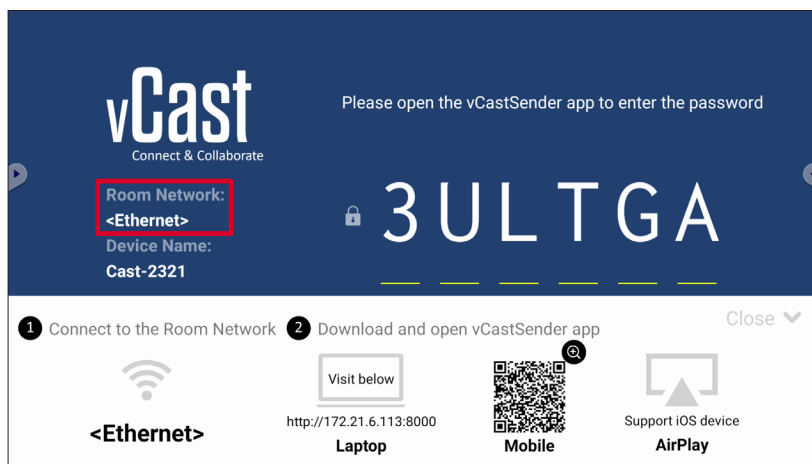

2. On the iOS client device, directly open AirPlay and select the **Device Name** of the display to connect.

**NOTE:** The **Device Name** can be found as highlighted below:

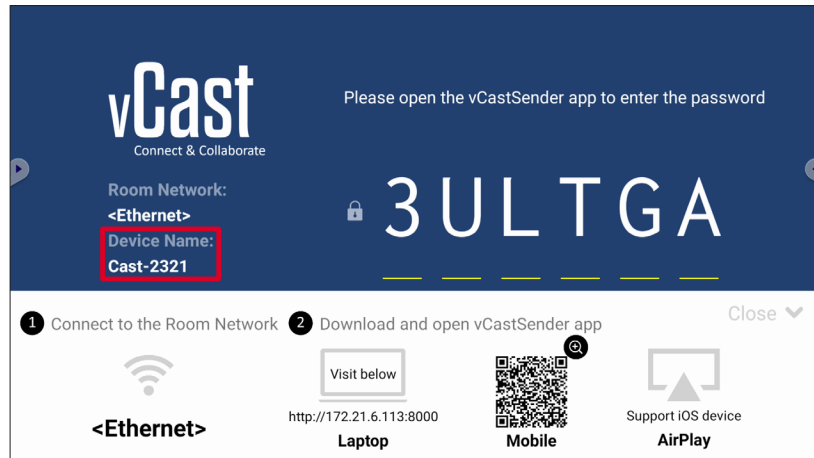

3. Input the generated on-screen **AirPlay Password** on the client device to connect.

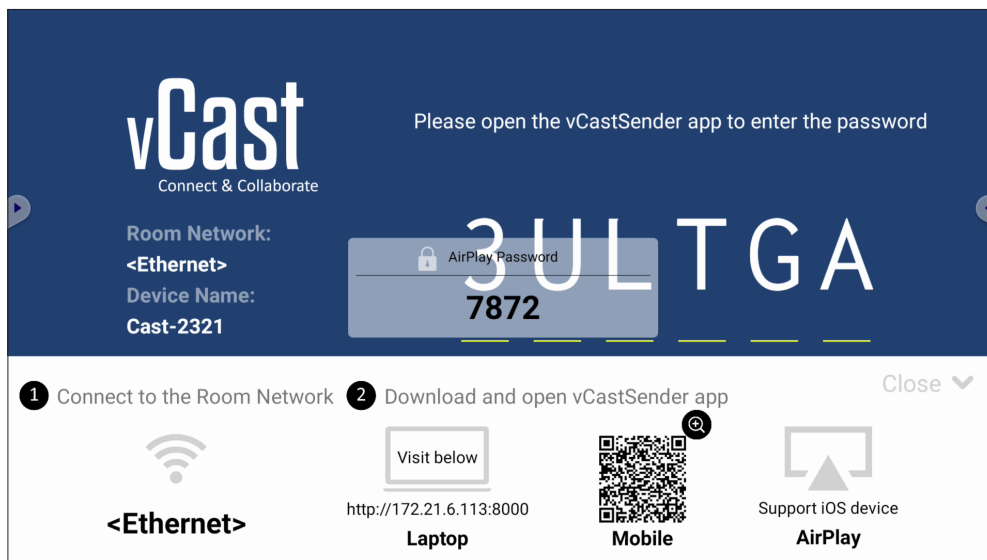

**NOTE:** In a cross subnet environment, please download and connect with the vCastSender iOS application from the Apple App Store.

4. You can also connect to the display by selecting **Scan** then placing the on-screen QR code into the box to automatically connect.

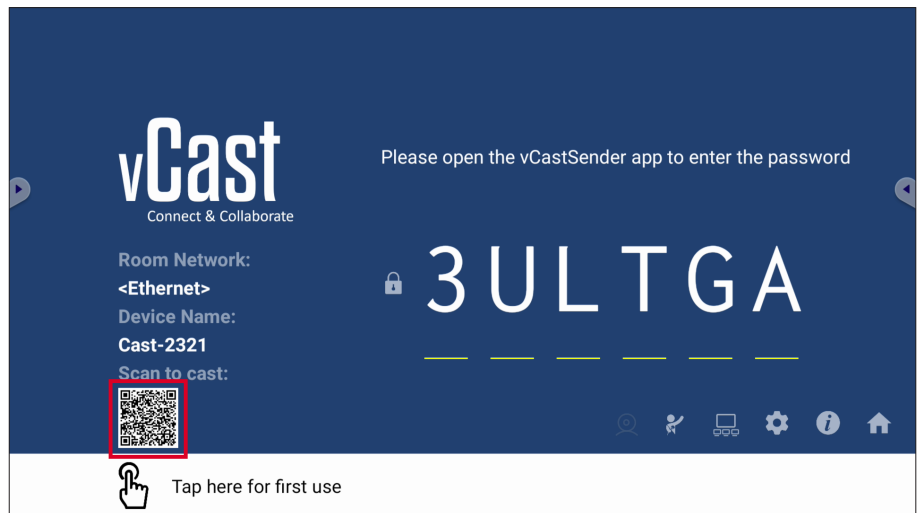
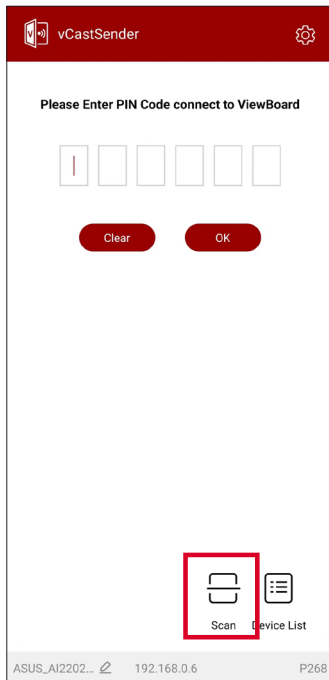

## Connecting to a ViewBoard from a Mobile Device

Once connected, select **Receive**. The display's screen will appear on the mobile device with an on-screen toolbar. Users can interact with the display with annotations, file sharing, etc.

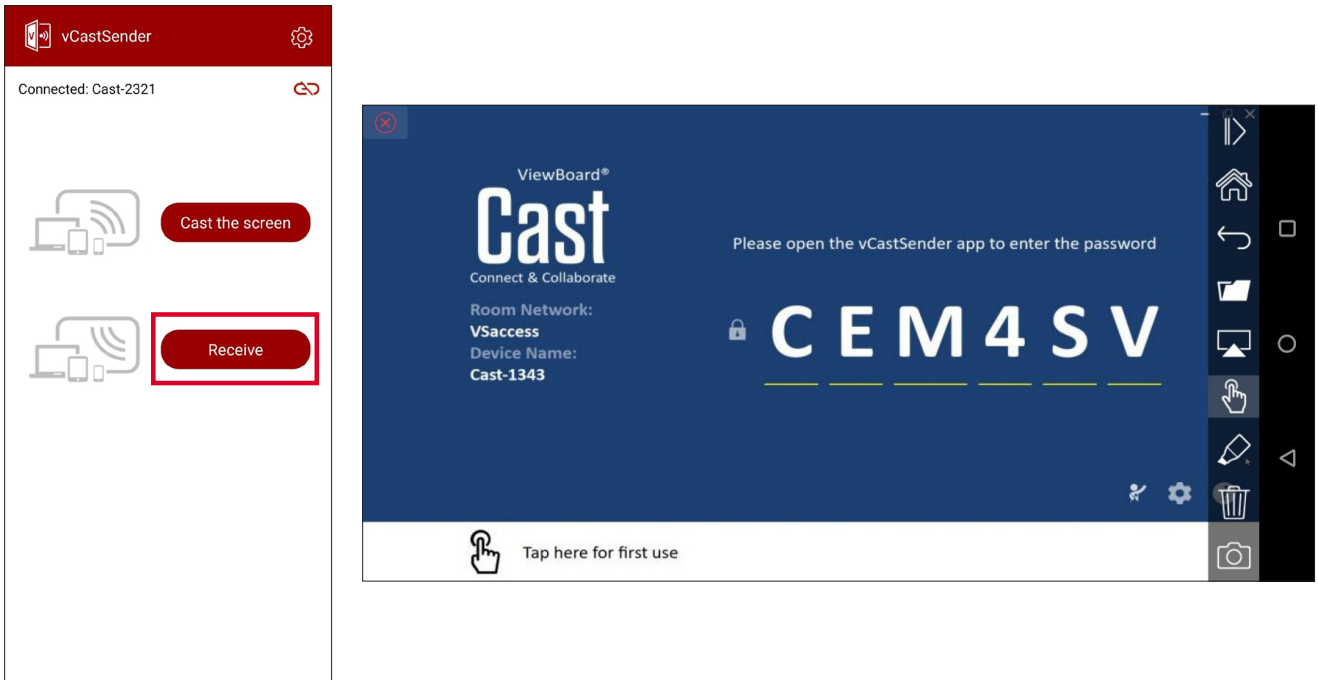

Item	Description
	<b>Toggle</b> Hide or display the toolbar.
	<b>Home</b> Return to the Home interface.
	<b>Return</b> Return to the previous operation.
	<b>Folder</b> View or open the mobile device's files.
	<b>Share</b> Cast the mobile device's screen to the connected display.
	<b>Touch</b> Remotely control the connected display.
	<b>Annotate</b> Make annotations, and adjust the pen color.
	<b>Clear</b> Clear everything on screen.
	<b>Camera</b> Send camera images to the connected display.

# Other Default Applications

## Browser

Web browser for surfing the Internet.

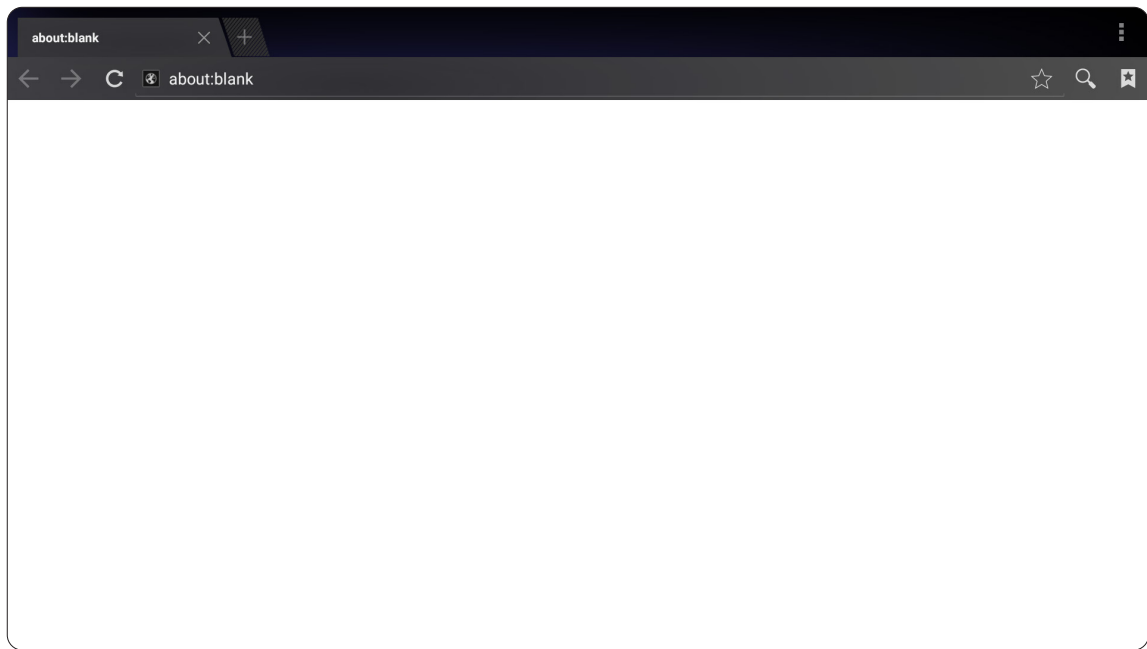

# OfficeSuite

Create, edit, and view documents, spreadsheets, presentations, and PDFs.

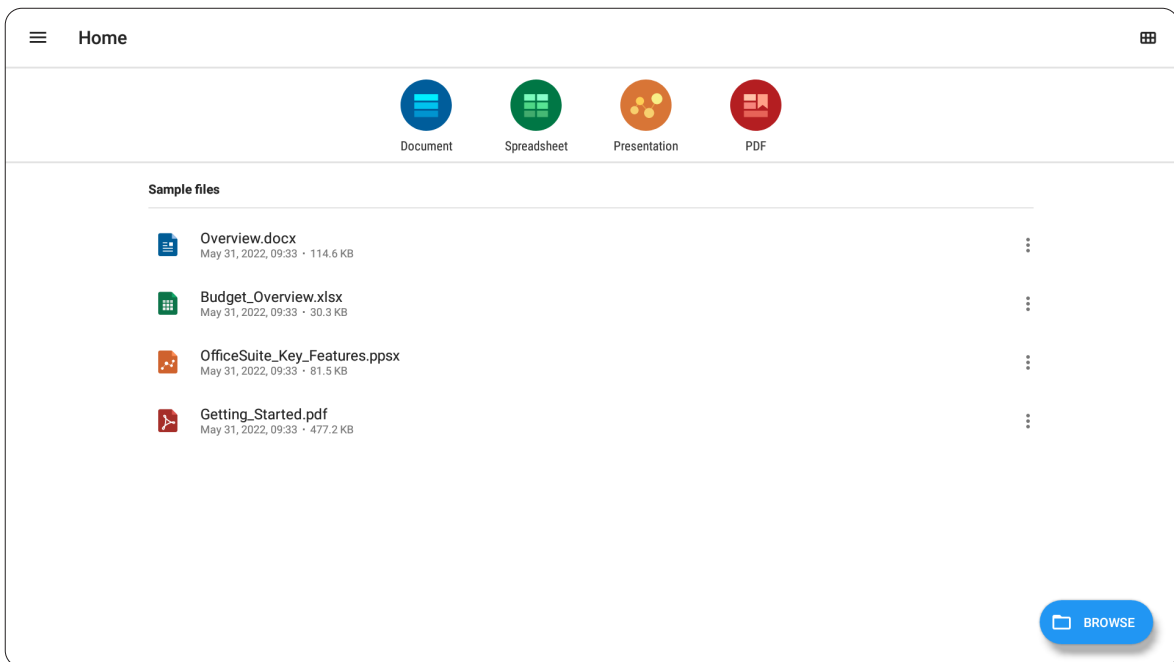
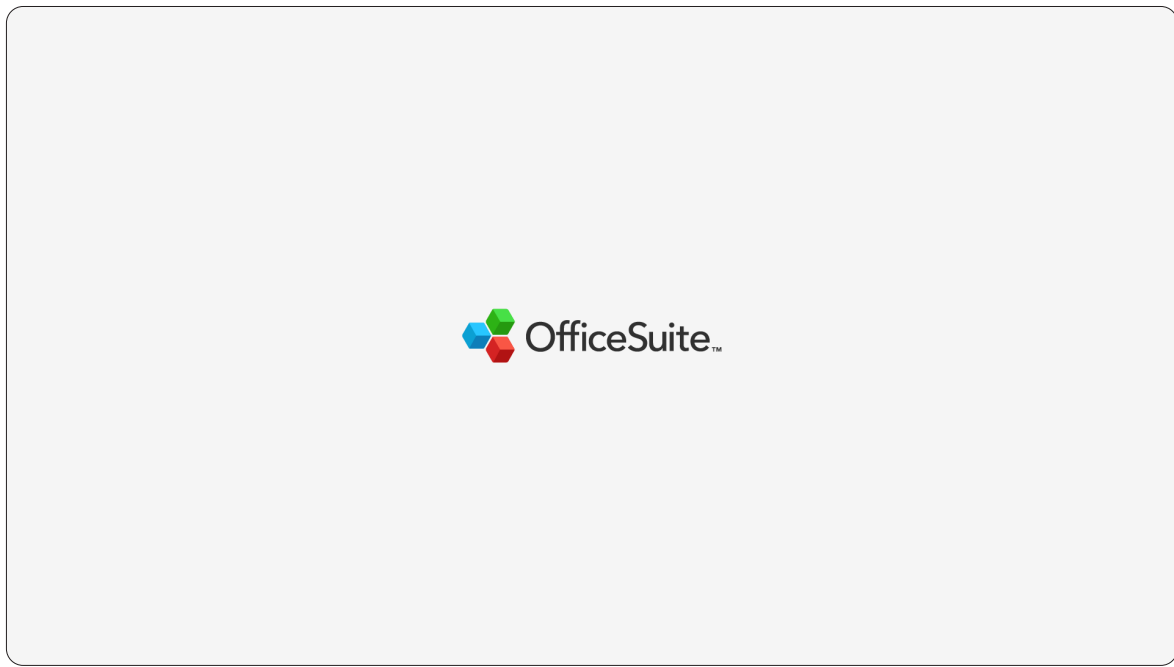

## vSweeper

Remove unnecessary data and unwanted files.

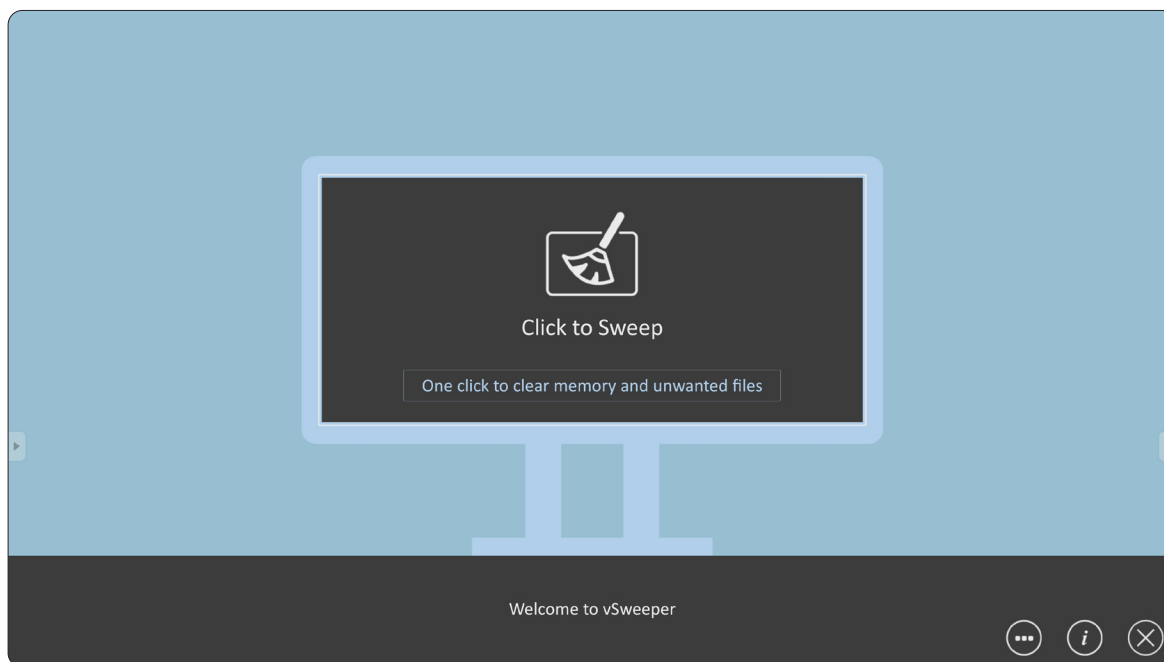

Advanced Settings can also be customized to the user's needs.

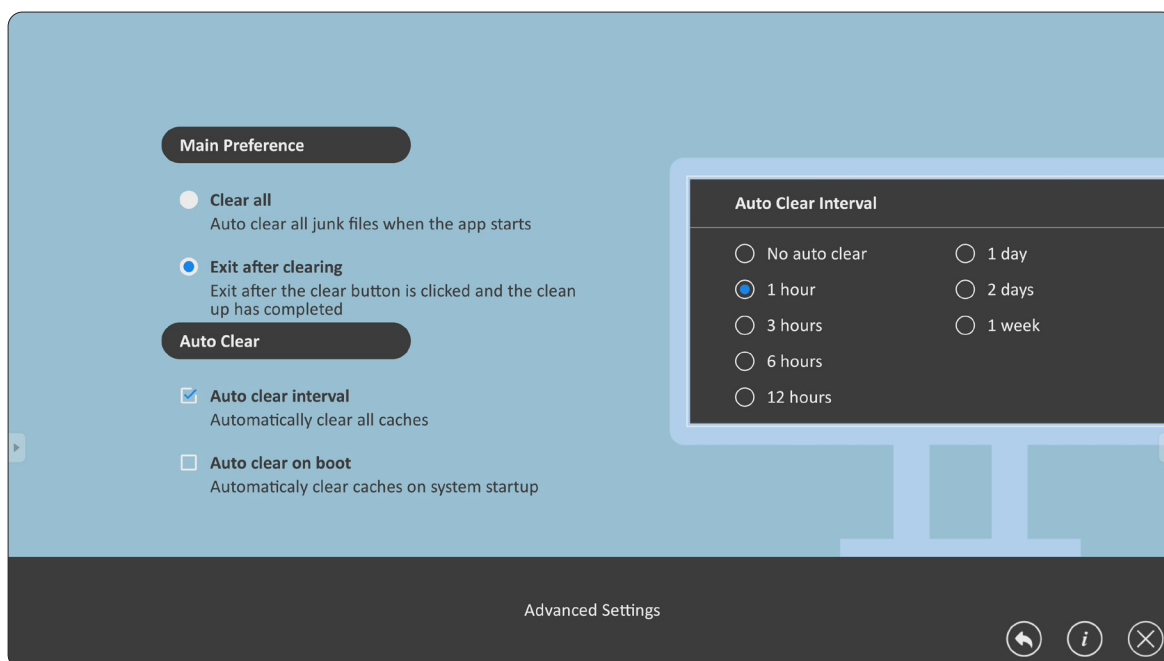



# Appendix

## Specifications

Item	Category	Specifications
Model		LDM136-151
LED Screen	Type	Direct View LED Display
	Size	136"
	Active Size (H x V)	3,000 mm x 1,687.5 mm
		118.11" x 66.44"
	Pitch Size	1.56 mm
	Resolution	FHD, 1920 x 1080
	Refresh Frequency	3840 Hz
	Contrast Ratio	6500:1 (Typical)
	Brightness	100-600 cd/m2 (100 levels of adjustment)
LED Lifespan	100,000 hours	
Input Signal		4 x HDMI (v. 2.0; HDCP 2.2)
		1 x USB Type A (2.0)
		1 x USB Type A (3.0)
		1 x LAN (RJ45)
		1 x IR in
		1 x USB Type C (data only)
		1 x RS-232 (for control)
		1 x RJ45 (for LAN control)
		1 x Wi-Fi Input (2.4 G/5 G Hz)
Output Signal		1 x HDMI Out
		2 x Audio Out (1 x 3.5 mm internal; 1 x 3.5 mm external)
		1 x USB Type A (Shared) [5V/2A]
Speaker Output		2 x 30W
RS-232		RS-232 Serial Control
Power	Voltage	100-120V/30A ~ 50/60Hz
		220-240V/15A ~ 50Hz (will vary by country)
Operating Conditions	Altitude	≤ 5,000 m
		≤ 16,404 ft
	Relative Humidity	10%~80% non-condensing
	Temperature	0° C to 40° C
32° F to 104° F		

Item	Category	Specifications
Storage Conditions	Altitude	≤ 5,000 m
		≤ 16,404 ft
	Relative Humidity	10%~85% non-condensing
	Temperature	-10° C to 60° C
14° F to 140° F		
Physical Dimensions (W x H x D)	Without Wall Mount	3012 x 1833.5 x 31 mm
		118.58" x 72.18" x 1.22"
	With Wall Mount	3012 x 1833.5 x 53 mm
		118.58" x 72.18" x 2.08"
	With Back Mount	3012 x 1833.5 x 91 mm
		118.58" x 72.18" x 3.58"
	With Trolley	3012 x 2507.8 x 872.2 mm
		118.58" x 98.73" x 34.33"
Weight	Without Wall Mount	162 kg
		357.15 lbs
	With Wall Mount	178 kg
		392.42 lbs
	With Back Mount	196 kg
		438.71 lbs
	With Trolley	225 kg
		432.11 lbs
Power Consumption	On	609W (Normal) 1740W (Max)
	Off	< 0.5W

**NOTE:** Product specifications are subject to change without notice.

# Timing Chart

## HDMI (PC)

Resolution	Refresh Rate
640 x 480	60 Hz
800 x 600	60 Hz
1024 x 768	60 Hz
1280 x 768	60 Hz
1280 x 800	60 Hz
1280 x 960	60 Hz
1280 x 1024	60 Hz
1360 x 768	60 Hz
1366 x 768	60 Hz
1400 x 1050	60 Hz
1440 x 900	60 Hz
1600 x 1200	60 Hz
1680 x 1050	60 Hz
1920 x 1080	60 Hz

## HDMI (Video)

Video	Resolution	Refresh Rate
480p	640 x 480	60 Hz
576p	720 x 576	50 Hz
800 x 600	800 x 600	60 Hz
1024 x 768	1024 x 768	60 Hz
720p	1280 x 720	50, 60 Hz
1080p	1920 x 1080	24, 25, 30, 50, 60 Hz
2560 x 1080	2560 x 1080	60 Hz
3440 x 1440	3440 x 1440	60 Hz
2160p	3840 x 2160	24, 25, 30, 50, 60 Hz

### NOTE:

- The computer text quality is optimal in HD 1080 mode (1920 x 1080, 60 Hz).
- Your computer display screen might appear different depending on the manufacturer and your operating system.
- Consult your computer's instructional manual on how to connect to an external display.
- If a vertical and horizontal frequency-select mode exists, select 60 Hz (vertical) and 67.5 kHz (horizontal). In some cases, abnormal signals (such as stripes) might appear on the screen when the computer power is turned off (or if the computer is disconnected). If this is the case, press the [INPUT SOURCE] button to enter the video mode and supply an active signal.
- The display timings conform to VESA and CTA standards.
- For 4:3 content, the screen will display them in the center of the screen and maintain a 4:3 aspect ratio.
- The optimal vertical frequency for each mode is 60Hz.
- **HDMI 3** does not support YUV420.

## Supported Media Formats

Type	File Type	Codec	Ability
Photo	.jpeg	JFIF file format 1.02	Max Resolution: 8176 x 8176 Min Resolution: 48 x 48
	.jpg	JFIF file format 1.02	Max Resolution: 8176 x 8176 Min Resolution: 48 x 48
	.bmp	BMP	Max Resolution: 8176 x 8176 Min Resolution: 48 x 49
	.gif	GIF	Max Resolution: 8176 x 8176 Min Resolution: 48 x 50
	.png	PNG	Max Resolution: 8176 x 8176 Min Resolution: 48 x 51
Audio	.mp1/2/3	MPEG 1/2 Layer 1/2/3	Bit rate: 8 kbps~320 kbps, CBR and VBR Sampling rate: 8 kHz~48 kHz
	.wma	WMA version 4, 4.1, 7, 8, 9, wmapro	Bit rate: 8 kbps~320 kbps Sampling rate: 8 kHz~48 kHz Non-support WMA Pro, lossless and MBR
	.wav	MS-ADPCM, IMA-ADPCM, PCM	Sampling rate: 8 kHz~48 kHz Support 4 bit MS-ADPCM, IMA-ADPCM
	.flac	Compress Level 0~8	Sampling rate: 8 kHz~48 kHz
	.aac\.m4a	ADIF ,ATDS Header AAC-LC and AAC-HE, AAC-ELD	Sampling rate: 8 kHz~48 kHz
	.oog\.oga	Q1~ Q10	Sampling rate: 8 kHz~48 kHz
Video	.3gp	MPEG4	Supported Image Size: 48 x 48 pixels to 1920 x 1080 pixels Maximum Frame Rate: 30 fps Maximum Bit Rate: 38.4 Mbps Not supported: MS MPEG4 v1, v2, v3 Not supported: GMC
		H.263	Supported Image Size: SQCIF (128 x 96), QCIF (176 x 144), CIF (352 x 288), 4CIF (704 x 576) Maximum Frame Rate: 30 fps Maximum Bit Rate: 38.4 Mbps Not supported: H.263+
		H.264	Supported Image Size: 48 x 48 pixels to 4096 x 2304 pixels Maximum Frame Rate: 2304p @ 30 fps, 1080p @ 60 fps Maximum Bit Rate: 100 Mbps Supported: Field Coding Supported: MBAFF

Type	File Type	Codec	Ability
Video	.asf	VC-1	Supported Image Size: 48 x 48 pixels to 1920 x 1080 pixels Maximum Frame Rate: 30 fps Maximum Bit Rate: 45 Mbps
	.avi	MPEG4	Supported Image Size: 48 x 48 pixels to 1920 x 1080 pixels Maximum Frame Rate: 30 fps Maximum Bit Rate: 38.4 Mbps Not supported: MS MPEG4 v1, v2, v3 Not supported: GMC
		H.264	Supported Image Size: 48 x 48 pixels to 4096 x 2304 pixels Maximum Frame Rate: 2304p @ 30 fps, 1080p @ 60 fps Maximum Bit Rate: 100 Mbps Supported: Field Coding Supported: MBAFF
		VC-1	Supported Image Size: 48 x 48 pixels to 1920 x 1080 pixels Maximum Frame Rate: 30 fps Maximum Bit Rate: 45 Mbps
		MJPEG	Supported Image Size: 48 x 48 pixels to 1920 x 1080 pixels Maximum Frame Rate: 30 fps Maximum Bit Rate: 38.4 Mbps
	.dat	MPEG-1/2	Supported Image Size: 48 x 48 pixels to 1920 x 1080 pixels Maximum Frame Rate: 30 fps Maximum Bit Rate: 80 Mbps Supported: Field Coding
	.flv	H.264	Supported Image Size: 48 x 48 pixels to 4096 x 2304 pixels Maximum Frame Rate: 2304p @ 30 fps, 1080p @ 60 fps Maximum Bit Rate: 100 Mbps Supported: Field Coding Supported: MBAFF

Type	File Type	Codec	Ability
Video	.mkv	MPEG4	Supported Image Size: 48 x 48 pixels to 1920 x 1080 pixels Maximum Frame Rate: 30 fps Maximum Bit Rate: 38.4 Mbps Not supported: MS MPEG4 v1, v2, v3 Not supported: GMC
		H.264	Supported Image Size: 48 x 48 pixels to 4096 x 2304 pixels Maximum Frame Rate: 2304p @ 30 fps, 1080p @ 60 fps Maximum Bit Rate: 100 Mbps Supported: Field Coding Supported: MBAFF
		H.264 MVC	Supported Image Size: 48 x 48 pixels to 4096 x 2304 pixels Maximum Frame Rate: 2304p @ 30 fps, 1080p @ 60 fps Maximum Bit Rate: 50 Mbps Supported: Stereo High Profile only
		H.265/HEVC	Supported Image Size: 64 x 64 pixels to 4096 x 2304 pixels Maximum Frame Rate: 2304p @ 60 fps Maximum Bit Rate: 100 Mbps Supported: Main Profile & Main10 Profile Supported: Tile & SLIC
		VC-1	Supported Image Size: 48 x 48 pixels to 1920 x 1080 pixels Maximum Frame Rate :30 fps Maximum Bit Rate: 45 Mbps
		VP8	Supported Image Size: 48 x 48 pixels to 1920 x 1080 pixels Maximum Frame Rate: 30 fps Maximum Bit Rate: 38.4 Mbps
		VP9	Supported Image Size: 48 x 48 pixels to 4096 x 2304 pixels Maximum Frame Rate: 2304p @ 60fps Maximum Bit Rate: 100 Mbps

Type	File Type	Codec	Ability
Video	.mov	MPEG4	Supported Image Size: 48 x 48 pixels to 1920 x 1080 pixels Maximum Frame Rate: 30 fps Maximum Bit Rate: 38.4 Mbps Not supported: MS MPEG4 v1, v2, v3 Not supported: GMC
		H.264	Supported Image Size: 48 x 48 pixels to 4096 x 2304 pixels Maximum Frame Rate: 2304p @ 30 fps, 1080p @ 60 fps Maximum Bit Rate: 100 Mbps Supported: Field Coding Supported: MBAFF
		H.265/HEVC	Supported Image Size: 64 x 64 pixels to 4096 x 2304 pixels Maximum Frame Rate: 2304p @ 60 fps Maximum Bit Rate: 100 Mbps Supported: Main Profile & Main10 Profile Supported: Tile & SLIC
		H.263	Supported Image Size: SQCIF (128 x 96), QCIF (176 x 144), CIF (352 x 288), 4CIF (704 x 576) Maximum Frame Rate: 30 fps Maximum Bit Rate: 38.4 Mbps Not supported: H.263+
	.mp4	MPEG4	Supported Image Size: 48 x 48 pixels to 1920 x 1080 pixels Maximum Frame Rate: 30 fps Maximum Bit Rate: 38.4 Mbps Not supported: MS MPEG4 v1, v2, v3 Not supported: GMC
	.mp5	H.264	Supported Image Size: 48 x 48 pixels to 4096 x 2304 pixels Maximum Frame Rate: 2304p @ 30 fps, 1080p @ 60 fps Maximum Bit Rate: 100 Mbps Supported: Field Coding Supported: MBAFF
	.mp6	H.265/HEVC	Supported Image Size: 64 x 64 pixels to 4096 x 2304 pixels Maximum Frame Rate: 2304p @ 60 fps Maximum Bit Rate: 100 Mbps Supported: Main Profile & Main10 Profile Supported: Tile & SLIC



Type	File Type	Codec	Ability
Video	.mp7	H.263	Supported Image Size: SQCIF (128 x 96), QCIF(176 x 144), CIF (352 x 288), 4CIF (704 x 576) Maximum Frame Rate: 30 fps Maximum Bit Rate: 38.4 Mbps Not supported: H.263+
	.mpg	MPEG-1/2	Supported Image Size: 48 x 48 pixels to 1920 x 1080 pixels Maximum Frame Rate: 30 fps Maximum Bit Rate: 80 Mbps Supported: Field Coding
	.ts	MPEG-1/2	Supported Image Size: 48 x 48 pixels to 1920 x 1080 pixels Maximum Frame Rate: 30 fps Maximum Bit Rate: 80 Mbps Supported: Field Coding
		H.264	Supported Image Size: 48 x 48 pixels to 4096 x 2304 pixels Maximum Frame Rate: 2304p @ 30 fps, 1080p @ 60 fps Maximum Bit Rate: 100 Mbps Supported: Field Coding Supported: MBAFF
		H.264 MVC	Supported Image Size: 48 x 48 pixels to 4096 x 2304 pixels Maximum Frame Rate: 2304p @ 30 fps, 1080p @ 60 fps Maximum Bit Rate: 50 Mbps Supported: Stereo High Profile only
		H.265/HEVC	Supported Image Size: 64 x 64 pixels to 4096 x 2304 pixels Maximum Frame Rate: 2304p @ 60 fps Maximum Bit Rate: 100 Mbps Supported: Main Profile & Main10 Profile Supported: Tile & SLIC
		VC-1	Supported Image Size: 48 x 48 pixels to 1920 x 1080 pixels Maximum Frame Rate: 30 fps Maximum Bit Rate: 45 Mbps
	.vob	MPEG-1/2	Supported Image Size: 48 x 48 pixels to 1920 x 1080 pixels Maximum Frame Rate: 30 fps Maximum Bit Rate: 80 Mbps Supported: Field Coding

Type	File Type	Codec	Ability
Video	.webm	VP8	Supported Image Size: 48 x 48 pixels to 1920 x 1080 pixels Maximum Frame Rate: 30 fps Maximum Bit Rate: 38.4 Mbps
		VP9	Supported Image Size: 48 x 48 pixels to 4096 x 2304 pixels Maximum Frame Rate: 2304p @ 60 fps Maximum Bit Rate: 100 Mbps
	.wmv	VC-1	Supported Image Size: 48 x 48 pixels to 1920 x 1080 pixels Maximum Frame Rate: 30 fps Maximum Bit Rate: 45 Mbps

## LED Display Stuck Pixel Definition

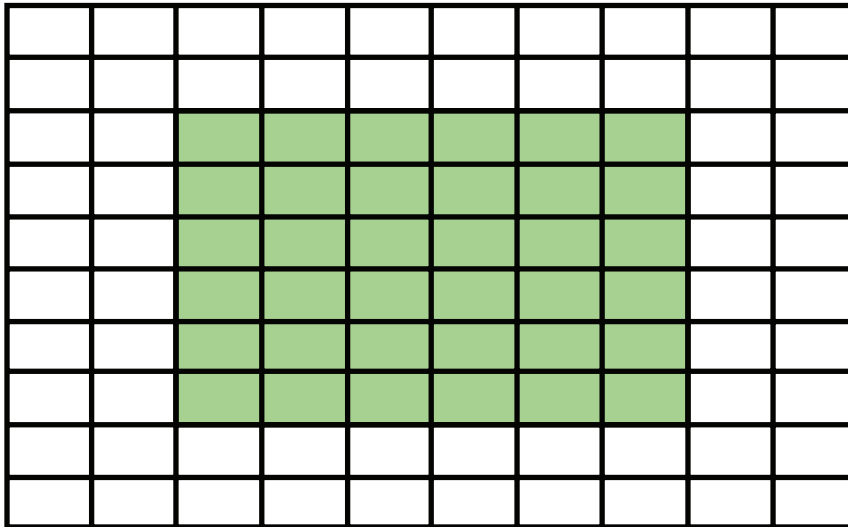

Item	Acceptance Criteria
Stuck Pixel (whole display)	$\leq 60$ stuck pixels
Stuck Pixel (as marked in green)	$\leq 15$ stuck pixels
Stuck Pixel (Single Module)	$\leq 6$ stuck pixels

# Maintenance Tools

## Vacuum Suction Tool (LED Module Maintenance Tool)

### Safety Precautions

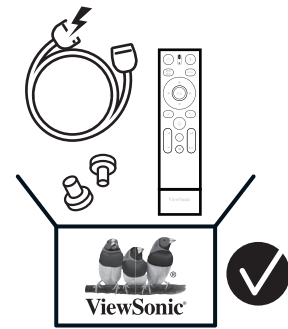
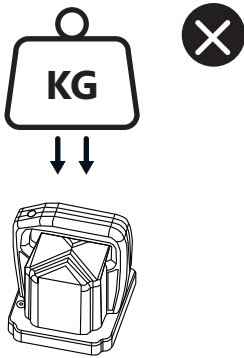
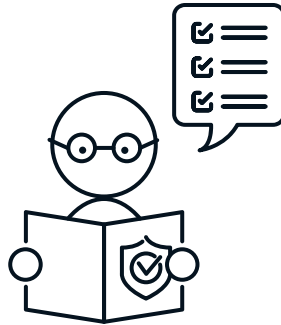
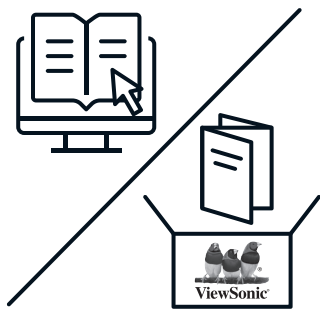

### Dimensions

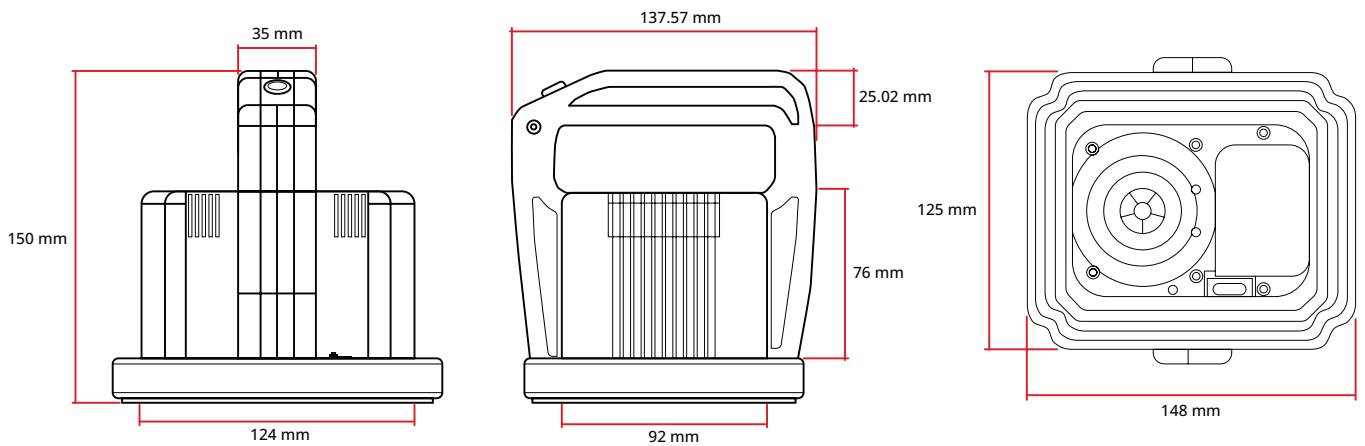

## Charging the Battery

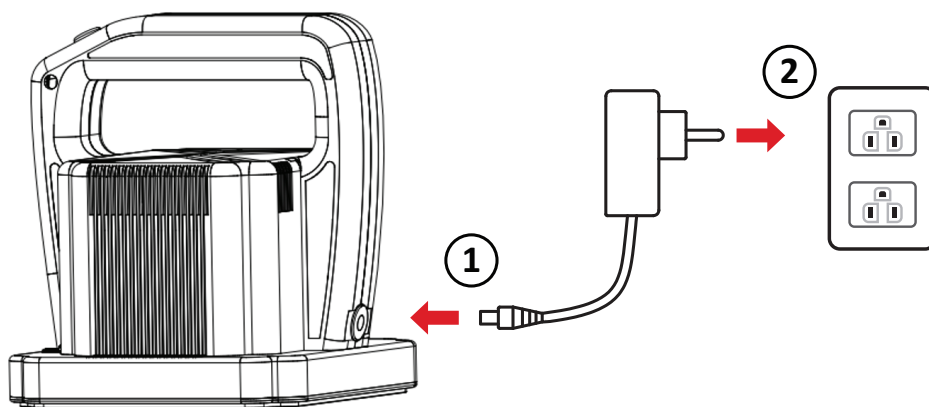

## Overview

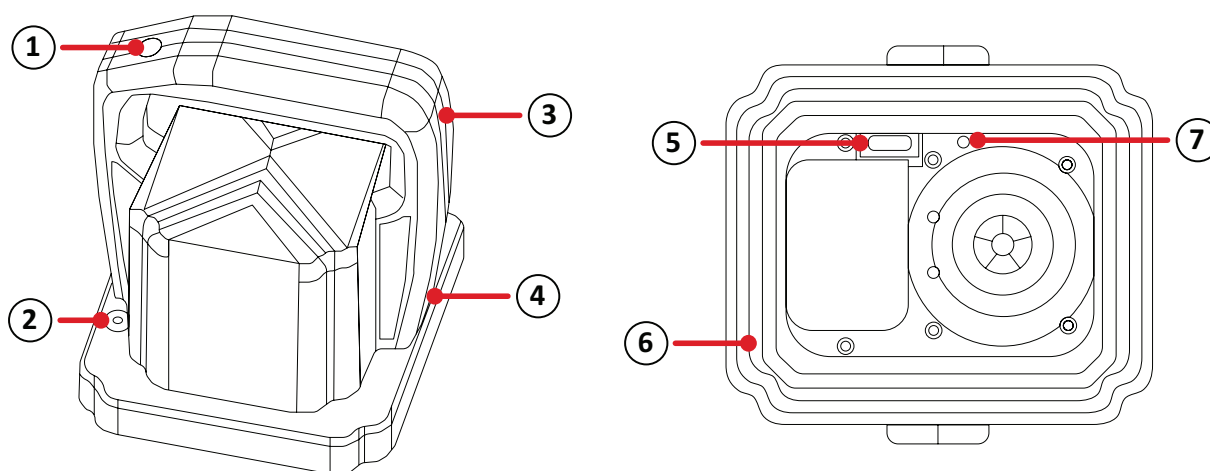

Number	Item	Description
1	Start Button	Start or stop the suction force.
2	Regulating Valve	Adjust the suction force level.
3	Handle	Pick up and hold the tool from here.
4	Charging Port	Port for charging the battery.
5	Power Switch	Turn the tool on or off.
6	LED Module Contact Silicone	Soft contact surface for removing the LED modules.
7	Power Display	Indicates how much battery power is remaining.

## Specifications

<b>Item</b>	<b>Description</b>
<b>Model</b>	LD-MK-003
<b>Product Dimension</b>	148 x 125 x 150 mm
	5.83" x 4.92" x 5.91"
<b>Weight</b>	0.9 kg
	1.98 lbs
<b>Working Duration</b>	18 minutes
<b>Operating Relative Humidity</b>	15%~85% (non-condensing)
<b>Operating Temperature</b>	-20° C to 45° C
	-4° F to 113° F

# System Control Box Maintenance Tool

## Dimensions

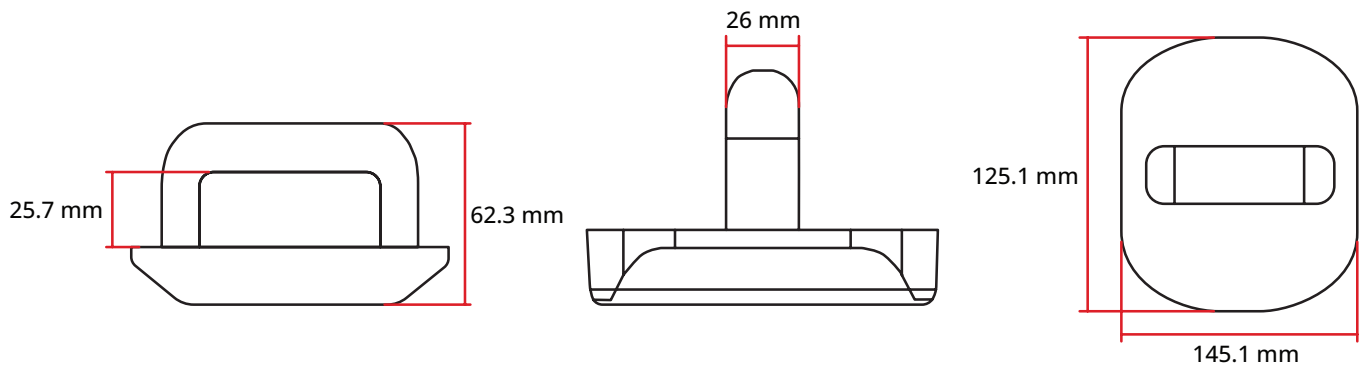

## Specifications

Item	Description
Model	LD-MK-004
Product Dimension	145.1 x 125.1 x 62.3 mm
	5.71" x 4.93" x 2.45"
Weight	0.5 kg
	1.10 lbs

# Troubleshooting

## General

Problem or Issue	Possible Solutions
Remote Control is not working	<ol style="list-style-type: none"><li>1. Check whether something is obstructing the display's remote control receiver.</li><li>2. Check whether the battery polarities in the remote control are installed correctly.</li><li>3. Check whether the batteries need to be replaced.</li></ol>
The unit turns off unexpectedly	<ol style="list-style-type: none"><li>1. Check whether Sleep mode is enabled.</li><li>2. Check if there is a power outage in your area.</li><li>3. Turn on the display, provide an active signal, and see if the problem is with the signal or external control system.</li><li>4. Check whether the Ethernet cables inside the cabinets are connected properly.</li></ol>
The power indicator is off, and there is no response	<ol style="list-style-type: none"><li>1. Ensure the power cable is connected and not loose.</li><li>2. Check that the power outlet is functioning properly and meets the required electrical requirement.</li></ol>
The display does not recognize the USB storage device	<ol style="list-style-type: none"><li>1. Ensure the drive is either formatted for FAT32 or NTFS.</li><li>2. If the USB storage device needs external power, connect its power adapter to an electrical outlet.</li></ol>



## Video Not Working Properly

Problem or Issue	Possible Solutions
No picture/No sound	<ol style="list-style-type: none"><li>1. Check the Power status.</li><li>2. Check the signal cable.</li><li>3. Use the remote control to ensure the input source setting is the same as the connected device.</li></ol>
Picture is unclear or cuts in and out	<ol style="list-style-type: none"><li>1. Check the signal cable.</li><li>2. Check if other electronics or different signal types are interrupting the signal.</li><li>3. An optional active video cable or optional video extender is required for a long distance source.</li></ol>
Poor picture	<ol style="list-style-type: none"><li>1. Adjust chroma and/or brightness settings in the menu.</li><li>2. Check the signal cable.</li><li>3. Use the display's native resolution for the source.</li></ol>

## Audio Not Working Properly

Problem or Issue	Possible Solutions
No sound	<ol style="list-style-type: none"><li>1. Press the Mute/Unmute button.</li><li>2. Adjust the volume.</li><li>3. Check the audio cable connection (if used).</li><li>4. If using a computer digital video with embedded audio, ensure the computer speakers are set to external speakers.</li></ol>

Problem or Issue	Possible Solutions
One speaker only	<ol style="list-style-type: none"><li data-bbox="555 197 1225 230">1. Adjust the sound balance in the menu.</li><li data-bbox="555 253 1449 342">2. Check the left and right sound control panel settings of the computer or media player source.</li><li data-bbox="555 365 1297 398">3. Check the audio cable connection (if used).</li><li data-bbox="555 421 1433 510">4. Ensure the content has two audio channels and not mono.</li></ol>

# Maintenance

## General Precautions

- The LED lights used in the modules are susceptible to ESD (Electrostatic discharge). To prevent damage to the LED lights, do not touch them with bare hands or with conductive materials when handling.
- Wear anti-static gloves and wrist strap when installing and servicing the display.
- It is recommended to regularly inspect all installed components.
- Do not bring objects close to the ventilation holes of the display. Burns or personal injuries may occur if any body parts are brought too close.
- Be sure to power off and disconnect all cables before moving the display. Moving the display with its cables attached may damage the cables and thus cause fire or electric shock.
- Power off and disconnect the power plug from the wall outlet as a safety precaution before performing any type of cleaning or maintenance.

## Initial Operation

- If a new screen has been stowed for less than three months, it can be used at normal brightness during its first use.
- If a new screen has been stowed for more than three months, the brightness should be set at 30% for its first use and allowed to operate for two hours continuously. After two hours of use, power off for 30 minutes. The new screen is now ready for normal brightness usage.

## Front Panel Cleaning Instructions

- Use cool, compressed air to remove dust when the power is off. If the dust cannot be removed, the LED module should be replaced.
- Do not scratch and do not put pressure on the panel surface with fingers or any abrasive object.
- Do not use volatile substances such as sprays, solvents, or thinners.

## **Cabinet Cleaning Instructions**

- Do not allow water or detergent to come into contact with the surface of the display. If water or moisture gets inside the unit, a system malfunction or electrical shock may occur.
- Do not scratch and do not put pressure on the cabinet with any abrasive objects of any kind.
- Do not use volatile substances such as sprays, solvents, or thinners on the cabinet.
- Do not place anything made from rubber or PVC near the cabinet for any extended periods of time.

## **Regular Use**

- It is recommended to turn on the display at least once a month for more than eight hours. During a wet and rainy season, it is recommended to turn on the display at least once a week.
- Avoid using full white, full red, full blue, or full green content for an extended period to avoid excessive power usage thus affecting the LED lifespan.

# RS-232 Protocol

This document describes the hardware interface and software protocols of RS-232 interface communication between the ViewSonic LED Display and computers or other control units with RS-232 protocol.

## Description

### RS-232 Hardware Specification

ViewSonic RS-232 serial port on the lower left side:

1. Connector type: DB 9-Pin Female.
2. Use of straight-through parallel cable for connection
3. Pin Assignment:

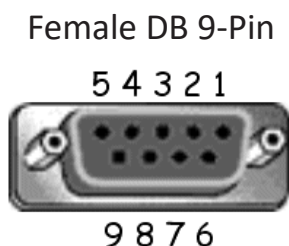

Pin #	Signal	Remark
1	NC	
2	RXD	Input to Display
3	TXD	Output from Display
4	NC	
5	GND	GND
6	NC	
7	NC	
8	NC	
9	NC	
frame	GND	

### RS-232 Communication Setting

- Baud Rate Select: 9600bps (fixed)
- Data bits: 8 bits (fixed)
- Parity: None (fixed)
- Stop Bits: 1 (fixed)

**NOTE:** Make sure the Control Board Switch is switched to the left for RS-232 control.

# Command Table

Function	Command Code (Hex)	Hex	Data Range
Power on/off(standby):STBY	21	38 30 31 73 21 30 30 30 0D	
Power on/off(standby):ON	21	38 30 31 73 21 30 30 31 0D	
Input Select:USB auto play	22	38 30 31 73 22 30 30 33 0D	
Input Select:HDMI1	22	38 30 31 73 22 30 30 34 0D	
Input Select:HDMI2	22	38 30 31 73 22 30 31 34 0D	
Input Select:HDMI3	22	38 30 31 73 22 30 32 34 0D	
Input Select:HDMI4	22	38 30 31 73 22 30 33 34 0D	
Brightness	24	38 30 31 73 24 3X 3X 3X 0D	000-100
Brightness:Bright down (-1)	24	38 30 31 73 24 39 30 30 0D	
Brightness:Bright up (+1)	24	38 30 31 73 24 39 30 31 0D	
Power lock:Unlock	34	38 30 31 73 34 30 30 30 0D	
Power lock:Lock	34	38 30 31 73 34 30 30 31 0D	
Volume	35	38 30 31 73 35 3X 3X 3X 0D	000-100
Volume:Volume down(-1)	35	38 30 31 73 35 39 30 30 0D	
Volume:Volume up(+1)	35	38 30 31 73 35 39 30 31 0D	
Mute:OFF	36	38 30 31 73 36 30 30 30 0D	
Mute:ON	36	38 30 31 73 36 30 30 31 0D	
Button lock:Unlock	38	38 30 31 73 38 30 30 30 0D	
Button lock:Lock	38	38 30 31 73 38 30 30 31 0D	
Menu lock:Unlock	3E	38 30 31 73 3E 30 30 30 0D	
Menu lock:Lock	3E	38 30 31 73 3E 30 30 31 0D	
Key Pad:UP	41	38 30 31 73 41 30 30 30 0D	
Key Pad:DOWN	41	38 30 31 73 41 30 30 31 0D	
Key Pad:LEFT	41	38 30 31 73 41 30 30 32 0D	
Key Pad:RIGHT	41	38 30 31 73 41 30 30 33 0D	
Key Pad:ENTER	41	38 30 31 73 41 30 30 34 0D	
Key Pad:INPUT	41	38 30 31 73 41 30 30 35 0D	
Key Pad:MENU/(EXIT)	41	38 30 31 73 41 30 30 36 0D	
Key Pad:EXIT	41	38 30 31 73 41 30 30 37 0D	
Key Pad:power on/off	41	38 30 31 73 41 30 30 38 0D	
Key Pad:inputlist	41	38 30 31 73 41 30 30 39 0D	
Key Pad:brightness	41	38 30 31 73 41 30 31 30 0D	
Key Pad:blank	41	38 30 31 73 41 30 31 31 0D	
Key Pad:home	41	38 30 31 73 41 30 31 32 0D	
Key Pad:volume+	41	38 30 31 73 41 30 31 33 0D	
Key Pad:volume-	41	38 30 31 73 41 30 31 34 0D	
Key Pad:next	41	38 30 31 73 41 30 31 35 0D	
Key Pad:previous	41	38 30 31 73 41 30 31 36 0D	
Key Pad:mute	41	38 30 31 73 41 30 31 37 0D	
Key Pad:play	41	38 30 31 73 41 30 31 38 0D	

Function	Command Code (Hex)	Hex	Data Range
Remote Control:Disable	42	38 30 31 73 42 30 30 30 0D	
Remote Control:Enable	42	38 30 31 73 42 30 30 31 0D	
Restore default	7E	38 30 31 73 7E 30 30 30 0D	
Input Select: Cycle	22	38 30 31 73 22 30 30 5A 0D	
Contrast	23	38 30 31 73 23 3X 3X 3X 0D	000-100
Sharpness	25	38 30 31 73 25 3X 3X 3X 0D	000-100
Color	26	38 30 31 73 26 3X 3X 3X 0D	000-100
Tint	27	38 30 31 73 27 3X 3X 3X 0D	000-100
Color mode:Normal	29	38 30 31 73 29 30 30 30 0D	
Color mode:Warm	29	38 30 31 73 29 30 30 31 0D	
Color mode:Cold	29	38 30 31 73 29 30 30 32 0D	
Color mode:Personal	29	38 30 31 73 29 30 30 33 0D	
Freeze:Off	2A	38 30 31 73 2A 30 30 30 0D	
Freeze:On	2A	38 30 31 73 2A 30 30 31 0D	
Bass	2E	38 30 31 73 2E 3X 3X 3X 0D	000-024
Treble	2F	38 30 31 73 2F 3X 3X 3X 0D	000-024
zoom mode:FULL(16:9)	31	38 30 31 73 31 30 30 30 0D	
zoom mode:NORMAL (4:3)	31	38 30 31 73 31 30 30 31 0D	
zoom mode:REAL (1:1)	31	38 30 31 73 31 30 30 32 0D	
zoom mode:21:9	31	38 30 31 73 31 30 30 33 0D	
OSD language:English	32	38 30 31 73 32 30 30 30 0D	
OSD language:French	32	38 30 31 73 32 30 30 31 0D	
OSD language:Spanish	32	38 30 31 73 32 30 30 32 0D	
OSD language:German	32	38 30 31 73 32 30 30 33 0D	
OSD language:Russian	32	38 30 31 73 32 30 30 34 0D	
OSD language:Dutch	32	38 30 31 73 32 30 30 35 0D	
OSD language:T-Chinese	32	38 30 31 73 32 30 30 36 0D	
OSD language:S-Chinese	32	38 30 31 73 32 30 30 37 0D	
OSD language:Turkish	32	38 30 31 73 32 30 30 38 0D	
OSD language:Arabic	32	38 30 31 73 32 30 30 39 0D	
PBP-Mode:Full Screen	39	38 30 31 73 39 30 30 30 0D	
PBP-Mode:Dual Screen	39	38 30 31 73 39 30 30 31 0D	
PBP-Mode:Three-part Screen	39	38 30 31 73 39 30 30 32 0D	
PBP-Mode:Quad Screen	39	38 30 31 73 39 30 30 33 0D	
PBP-Sound select:Main	3A	38 30 31 73 3A 30 30 30 0D	
PBP-Sound select:Sub	3A	38 30 31 73 3A 30 30 31 0D	
Date: Year	56	38 30 31 73 56 59 3X 3X 0D	17-99
Date: Month	56	38 30 31 73 56 4D 3X 3X 0D	01-12
Date: Day	56	38 30 31 73 56 44 3X 3X 0D	01-31
Time: Hour	57	38 30 31 73 57 48 3X 3X 0D	00-23
Time: Min	57	38 30 31 73 57 4D 3X 3X 0D	00-59





# Regulatory and Service Information

## Compliance Information

This section addresses all connected requirements and statements regarding regulations. Confirmed corresponding applications shall refer to nameplate labels and relevant markings on the unit.

### FCC Compliance Statement

This device complies with part 15 of FCC Rules. Operation is subject to the following two conditions: (1) this device may not cause harmful interference, and (2) this device must accept any interference received, including interference that may cause undesired operation. This equipment has been tested and found to comply with the limits for a Class B digital device, pursuant to part 15 of the FCC Rules.

These limits are designed to provide reasonable protection against harmful interference in a residential installation. This equipment generates, uses, and can radiate radio frequency energy, and if not installed and used in accordance with the instructions, may cause harmful interference to radio communications. However, there is no guarantee that interference will not occur in a particular installation. If this equipment does cause harmful interference to radio or television reception, which can be determined by turning the equipment off and on, the user is encouraged to try to correct the interference by one or more of the following measures:

- Reorient or relocate the receiving antenna.
- Increase the separation between the equipment and receiver.
- Connect the equipment into an outlet on a circuit different from that to which the receiver is connected.
- Consult the dealer or an experienced radio/TV technician for help.

The antenna(s) used for this transmitter must not be collocated or operating in conjunction with any other antenna or transmitter.

The device was tested and complies to measurement standards and procedures specified in FCC CFR Title 47 Part 15 Subpart C.

## **FCC Radiation Exposure Statement**

This equipment complies with FCC radiation exposure limits set forth for an uncontrolled environment. End users must follow the specific operating instructions for satisfying RF exposure compliance.

This transmitter must not be co-located or operating in conjunction with any other antenna or transmitter. This equipment should be installed and operated with a minimum distance of 20 centimeters between the radiator and your body.

The users manual or instruction manual for an intentional or unintentional radiator shall caution the user that changes or modifications not expressly approved by the party responsible for compliance could void the user's authority to operate the equipment.

**Warning:** You are cautioned that changes or modifications not expressly approved by the party responsible for compliance could void your authority to operate the equipment.

## **IC Warning Statement**

This device complies with Industry Canada license- exempt RSS standard(s). Operation is subject to the following two conditions: (1) this device may not cause interference, and (2) this device must accept any interference, including interference that may cause undesired operation of the device.

Le présent appareil est conforme aux CNR d'Industrie Canada applicables aux appareils radio exempts de licence. L'exploitation est autorisée aux deux conditions suivantes : ( 1 ) l'appareil ne doit pas produire de brouillage, et ( 2 ) l'utilisateur de l'appareil doit accepter tout brouillage radioélectrique subi, même si le brouillage est susceptible d'en compromettre le fonctionnement.

## **Country Code Statement**

For product available in the USA/Canada market, only channel 1~11 can be operated. Selection of other channels is not possible.

Pour les produits disponibles aux États-Unis/Canada du marché, seul le canal 1 à 11 peuvent être exploités. Sélection d'autres canaux n'est pas possible.

## IC Radiation Exposure Statement

This equipment complied with IC RSS-102 radiation exposure limits set forth for an uncontrolled environment. This equipment should be installed and operated with minimum distance 20cm between the radiator & your body. The device for the band 5150-5825 MHz is only for indoor usage to reduce potential for harmful interference to co-channel mobile satellite systems.

Cet équipement est conforme aux limites d'exposition aux rayonnements IC établies pour un environnement non contrôlé. Cet équipement doit être installé et utilisé avec un minimum de 20cm de distance entre la source de rayonnement et votre corps. Les dispositifs fonctionnant dans la bande 5150-5825 MHz sont réservés uniquement pour une utilisation à l'intérieur afin de réduire les risques de brouillage préjudiciable aux systèmes de satellites mobiles utilisant les mêmes canaux.

## CE Conformity for European Countries

 The device complies with the EMC Directive 2014/30/EU, Low Voltage Directive 2014/35/EU, and Radio Equipment Directive 2014/53/EU.

### The following information is only for EU-member states:

The mark shown to the right is in compliance with the Waste Electrical and Electronic Equipment Directive 2012/19/EU (WEEE). The mark indicates the requirement NOT to dispose of the equipment as unsorted municipal waste, but use the return and collection systems according to local law.



## Declaration of RoHS2 Compliance

This product has been designed and manufactured in compliance with Directive 2011/65/EU of the European Parliament and the Council on restriction of the use of certain hazardous substances in electrical and electronic equipment (RoHS2 Directive) and is deemed to comply with the maximum concentration values issued by the European Technical Adaptation Committee (TAC) as shown below:

Substance	Proposed Maximum Concentration	Actual Concentration
Lead (Pb)	0.1%	< 0.1%
Mercury (Hg)	0.1%	< 0.1%
Cadmium (Cd)	0.01%	< 0.01%
Hexavalent Chromium (Cr6 <sup>+</sup> )	0.1%	< 0.1%
Polybrominated biphenyls (PBB)	0.1%	< 0.1%
Polybrominated diphenyl ethers (PBDE)	0.1%	< 0.1%
Bis (2-ethylhexyl) phthalate (DEHP)	0.1%	< 0.1%
Butyl benzyl phthalate (BBP)	0.1%	< 0.1%
Dibutyl phthalate (DBP)	0.1%	< 0.1%
Diisobutyl phthalate (DIBP)	0.1%	< 0.1%

**Certain components of products as stated above are exempted under the Annex III of the RoHS2 Directives as noted below. Examples of exempted components are:**

- Copper alloy containing up to 4% lead by weight.
- Lead in high melting temperature type solders (i.e. lead-based alloys containing 85% by weight or more lead).
- Electrical and electronic components containing lead in a glass or ceramic other than dielectric ceramic in capacitors, e.g. piezoelectronic devices, or in a glass or ceramic matrix compound.
- Lead in dielectric ceramic in capacitors for a rated voltage of 125V AC or 250V DC or higher.

## European Union Regulatory Conformance

The equipment complies with the RF Exposure Requirement 2014/53/EU, Council Recommendation of 16 April 2014 on the limitation of exposure of the general public to electromagnetic fields (0-300 GHz). This equipment meets the following conformance standards: EN301489-1, EN301489-17, EN62368-1, EN300328.

We, hereby, declare that this Wi-Fi radio is in compliance with the essential requirements and other relevant provisions of Directive 2014/53/EU.

## Indian Restriction of Hazardous Substances

Restriction on Hazardous Substances statement (India). This product complies with the "India E-waste Rule 2011" and prohibits use of lead, mercury, hexavalent chromium, polybrominated biphenyls or polybrominated diphenyl ethers in concentrations exceeding 0.1 weight % and 0.01 weight % for cadmium, except for the exemptions set in Schedule 2 of the Rule.

## Product Disposal at End of Product Life

ViewSonic® respects the environment and is committed to working and living green. Thank you for being part of Smarter, Greener Computing. Please visit the ViewSonic® website to learn more.

### USA & Canada:

<https://www.viewsonic.com/us/go-green-with-viewsonic>

### Europe:

<https://www.viewsonic.com/eu/go-green-with-viewsonic>

### Taiwan:

<https://recycle.moenv.gov.tw/>

**For EU users, please contact us for any safety/accident issue experienced with this product:**

ViewSonic Europe Limited



Haaksbergweg 75  
1101 BR Amsterdam  
Netherlands



+31 (0) 650608655



[EPREL@viewsoniceurope.com](mailto:EPREL@viewsoniceurope.com)



<https://www.viewsonic.com/eu/>

## Copyright Information

Copyright© ViewSonic® Corporation, 2024. All rights reserved.

Macintosh and Power Macintosh are registered trademarks of Apple Inc.

Microsoft, Windows, and the Windows logo are registered trademarks of Microsoft Corporation in the United States and other countries.

ViewSonic® and the three birds logo are registered trademarks of ViewSonic® Corporation.

VESA is a registered trademark of the Video Electronics Standards Association. DPMS, DisplayPort, and DDC are trademarks of VESA.

**Disclaimer:** ViewSonic® Corporation shall not be liable for technical or editorial errors or omissions contained herein; nor for incidental or consequential damages resulting from furnishing this material, or the performance or use of this product.

In the interest of continuing product improvement, ViewSonic® Corporation reserves the right to change product specifications without notice. Information in this document may change without notice.

No part of this document may be copied, reproduced, or transmitted by any means, for any purpose without prior written permission from ViewSonic® Corporation.

# Customer Service

For technical support or product service, see the table below or contact your reseller.

**NOTE:** You will need the product’s serial number.

Country/ Region	Website	Country/ Region	Website
<b>Asia Pacific &amp; Africa</b>			
Australia	<a href="http://www.viewsonic.com/au/">www.viewsonic.com/au/</a>	Bangladesh	<a href="http://www.viewsonic.com/bd/">www.viewsonic.com/bd/</a>
中国 (China)	<a href="http://www.viewsonic.com.cn">www.viewsonic.com.cn</a>	香港 (繁體中文)	<a href="http://www.viewsonic.com/hk/">www.viewsonic.com/hk/</a>
Hong Kong (English)	<a href="http://www.viewsonic.com/hk-en/">www.viewsonic.com/hk-en/</a>	India	<a href="http://www.viewsonic.com/in/">www.viewsonic.com/in/</a>
Indonesia	<a href="http://www.viewsonic.com/id/">www.viewsonic.com/id/</a>	Israel	<a href="http://www.viewsonic.com/il/">www.viewsonic.com/il/</a>
日本 (Japan)	<a href="http://www.viewsonic.com/jp/">www.viewsonic.com/jp/</a>	Korea	<a href="http://www.viewsonic.com/kr/">www.viewsonic.com/kr/</a>
Malaysia	<a href="http://www.viewsonic.com/my/">www.viewsonic.com/my/</a>	Middle East	<a href="http://www.viewsonic.com/me/">www.viewsonic.com/me/</a>
Myanmar	<a href="http://www.viewsonic.com/mm/">www.viewsonic.com/mm/</a>	Nepal	<a href="http://www.viewsonic.com/np/">www.viewsonic.com/np/</a>
New Zealand	<a href="http://www.viewsonic.com/nz/">www.viewsonic.com/nz/</a>	Pakistan	<a href="http://www.viewsonic.com/pk/">www.viewsonic.com/pk/</a>
Philippines	<a href="http://www.viewsonic.com/ph/">www.viewsonic.com/ph/</a>	Singapore	<a href="http://www.viewsonic.com/sg/">www.viewsonic.com/sg/</a>
臺灣 (Taiwan)	<a href="http://www.viewsonic.com/tw/">www.viewsonic.com/tw/</a>	ประเทศไทย	<a href="http://www.viewsonic.com/th/">www.viewsonic.com/th/</a>
Việt Nam	<a href="http://www.viewsonic.com/vn/">www.viewsonic.com/vn/</a>	South Africa & Mauritius	<a href="http://www.viewsonic.com/za/">www.viewsonic.com/za/</a>
<b>Americas</b>			
United States	<a href="http://www.viewsonic.com/us">www.viewsonic.com/us</a>	Canada	<a href="http://www.viewsonic.com/us">www.viewsonic.com/us</a>
Latin America	<a href="http://www.viewsonic.com/la">www.viewsonic.com/la</a>		
<b>Europe</b>			
Europe	<a href="http://www.viewsonic.com/eu/">www.viewsonic.com/eu/</a>	France	<a href="http://www.viewsonic.com/fr/">www.viewsonic.com/fr/</a>
Deutschland	<a href="http://www.viewsonic.com/de/">www.viewsonic.com/de/</a>	Қазақстан	<a href="http://www.viewsonic.com/kz/">www.viewsonic.com/kz/</a>
Россия	<a href="http://www.viewsonic.com/ru/">www.viewsonic.com/ru/</a>	España	<a href="http://www.viewsonic.com/es/">www.viewsonic.com/es/</a>
Türkiye	<a href="http://www.viewsonic.com/tr/">www.viewsonic.com/tr/</a>	Україна	<a href="http://www.viewsonic.com/ua/">www.viewsonic.com/ua/</a>
United Kingdom	<a href="http://www.viewsonic.com/uk/">www.viewsonic.com/uk/</a>		

## Limited Warranty

### ViewSonic® Commercial Display

#### What the warranty covers:

ViewSonic® warrants its products to be free from defects in material and workmanship during the warranty period. If a product proves to be defective in material or workmanship during the warranty period, ViewSonic® will, at its sole option, and as your sole remedy, repair or replace the product with a similar product. Replacement Product or parts may include remanufactured or refurbished parts or components. The repair or replacement unit or parts or components will be covered by the balance of the time remaining on the customer's original limited warranty and the warranty period will not be extended. ViewSonic® provides no warranty for any third-party software whether included with the product or installed by the customer, installation of any unauthorized hardware parts or components (e.g. Projector Lamps). (Please refer to: "What the warranty excludes and does not cover" section).

#### Who the warranty protects:

This warranty is valid only for the first consumer purchaser.

#### What the warranty excludes and does not cover:

- Any product on which the serial number has been defaced, modified, or removed.
- Damage, deterioration, or malfunction resulting from:
  - » Accident, misuse, neglect, fire, water, lightning, or other acts of nature, unauthorized product modification, or failure to follow instructions supplied with the product.
  - » Repair or attempted repair by anyone not authorized by ViewSonic®.
  - » Damage to or loss of any programs, data, or removable storage media.
  - » Normal wear and tear.
  - » Removal or installation of the product.
- Software or data loss occurring during repair or replacement.
- Any damage of the product due to shipment.
- Causes external to the product, such as electric power fluctuations or failure.
- Use of supplies or parts not meeting ViewSonic's specifications.
- Failure of owner to perform periodic product maintenance as stated in the User Guide.



- Any other cause which does not relate to a product defect.
- Damage caused by static (non-moving) images displayed for lengthy periods of time (also referred to as image burn-in).
- Software - Any third-party software included with the product or installed by the customer.
- Hardware/Accessories/Parts/Components – Installation of any unauthorized hardware, accessories, consumable parts or components (e.g. Projector Lamps).
- Damage to, or abuse of, the coating on the surface of the display through inappropriate cleaning as described in the product User Guide.
- Removal, installation, and set-up service charges, including wall-mounting of the product.

### **How to get service:**

- For information about receiving service under warranty, contact ViewSonic® Customer Support (Please refer to the “Customer Service” page). You will need to provide your product’s serial number.
- To obtain warranty service, you will be required to provide: (a) the original dated sales slip, (b) your name, (c) your address, (d) a description of the problem, and (e) the serial number of the product.
- Take or ship the product, freight prepaid, in the original container to an authorized ViewSonic® service center or ViewSonic®.
- For additional information or the name of the nearest ViewSonic® service center, contact ViewSonic®.

### **Limitation of implied warranties:**

There are no warranties, express or implied, which extend beyond the description contained herein including the implied warranty of merchantability and fitness for a particular purpose.

**Exclusion of damages:**

ViewSonic's liability is limited to the cost of repair or replacement of the product. ViewSonic® shall not be liable for:

- Damage to other property caused by any defects in the product, damages based upon inconvenience, loss of use of the product, loss of time, loss of profits, loss of business opportunity, loss of goodwill, interference with business relationships, or other commercial loss, even if advised of the possibility of such damages.
- Any other damages, whether incidental, consequential or otherwise.
- Any claim against the customer by any other party.
- Repair or attempted repair by anyone not authorized by ViewSonic®.

**Effect of state law:**

This warranty gives you specific legal rights, and you may also have other rights which vary from state to state. Some states do not allow limitations on implied warranties and/or do not allow the exclusion of incidental or consequential damages, so the above limitations and exclusions may not apply to you.

**Sales outside the U.S.A. and Canada:**

For warranty information and service on ViewSonic® products sold outside of the U.S.A. and Canada, contact ViewSonic® or your local ViewSonic® dealer.

The warranty period for this product in mainland China (Hong Kong, Macao, and Taiwan Excluded) is subject to the terms and conditions of the Maintenance Guarantee Card.

For users in Europe and Russia, full details of warranty provided can be found at: <http://www.viewsonic.com/eu/> under "Support/Warranty Information".

## **Mexico Limited Warranty**

### ViewSonic® Commercial Display

#### **What the warranty covers:**

ViewSonic® warrants its products to be free from defects in material and workmanship, under normal use, during the warranty period. If a product proves to be defective in material or workmanship during the warranty period, ViewSonic® will, at its sole option, repair or replace the product with a like product. Replacement product or parts may include remanufactured or refurbished parts or components & accessories.

#### **Who the warranty protects:**

This warranty is valid only for the first consumer purchaser.

#### **What the warranty excludes and does not cover:**

- Any product on which the serial number has been defaced, modified or removed.
- Damage, deterioration, or malfunction resulting from:
  - » Accident, misuse, neglect, fire, water, lightning, or other acts of nature, unauthorized product modification, unauthorized attempted repair, or failure to follow instructions supplied with the product.
  - » Causes external to the product, such as electrical power fluctuations or failure.
  - » Use of supplies or parts not meeting ViewSonic®'s specifications.
  - » Normal wear and tear.
  - » Any other cause which does not relate to a product defect.
- Any product exhibiting a condition commonly known as “image burn-in” which results when a static image is displayed on the product for an extended period of time.
- Removal, installation, insurance, and set-up service charges.

**How to get service:**

For information about receiving service under warranty, contact ViewSonic® Customer Support (Please refer to the attached “Customer Service” page). You will need to provide your product’s serial number, so please record the product information in the space provided below on your purchase for your future use. Please retain your receipt of proof of purchase to support your warranty claim.

**For Your Records**

Product Name: \_\_\_\_\_ Model Number: \_\_\_\_\_  
Document Number: \_\_\_\_\_ Serial Number: \_\_\_\_\_  
Purchase Date: \_\_\_\_\_ Extended Warranty Purchase? \_\_\_\_\_(Y/N)  
If so, what date does warranty expire? \_\_\_\_\_

- To obtain warranty service, you will be required to provide (a) the original dated sales slip, (b) your name, (c) your address, (d) a description of the problem, and (e) the serial number of the product.
- Take or ship the product, in the original container packaging, to an authorized ViewSonic® service center.
- Round trip transportation costs for in-warranty products will be paid by ViewSonic®.

**Limitation of implied warranties:**

There are no warranties, express or implied, which extend beyond the description contained herein including the implied warranty of merchantability and fitness for a particular purpose.

**Exclusion of damages:**

ViewSonic®’s liability is limited to the cost of repair or replacement of the product. ViewSonic® shall not be liable for:

- Damage to other property caused by any defects in the product, damages based upon inconvenience, loss of use of the product, loss of time, loss of profits, loss of business opportunity, loss of goodwill, interference with business relationships, or other commercial loss, even if advised of the possibility of such damages.
- Any other damages, whether incidental, consequential or otherwise.
- Any claim against the customer by any other party.
- Repair or attempted repair by anyone not authorized by ViewSonic®.

Contact Information for Sales & Authorized Service (Centro Autorizado de Servicio) within Mexico:	
<b>Name, address, of manufacturer and importers:</b> México, Av. de la Palma #8 Piso 2 Despacho 203, Corporativo Interpalmas, Col. San Fernando Huixquilucan, Estado de México Tel: (55) 3605-1099 <a href="http://www.viewsonic.com/la/soporte/index.htm">http://www.viewsonic.com/la/soporte/index.htm</a>	
NÚMERO GRATIS DE ASISTENCIA TÉCNICA PARA TODO MÉXICO: 001.866.823.2004	
<b>Hermosillo:</b> Distribuciones y Servicios Computacionales SA de CV. Calle Juarez 284 local 2 Col. Bugambilias C.P: 83140 Tel: 01-66-22-14-9005 E-Mail: <a href="mailto:disc2@hmo.megared.net.mx">disc2@hmo.megared.net.mx</a>	<b>Villahermosa:</b> Compumantenimientos Garantizados, S.A. de C.V. AV. GREGORIO MENDEZ #1504 COL, FLORIDA C.P. 86040 Tel: 01 (993) 3 52 00 47 / 3522074 / 3 52 20 09 E-Mail: <a href="mailto:compumantenimientos@prodigy.net.mx">compumantenimientos@prodigy.net.mx</a>
<b>Puebla, Pue. (Matriz):</b> RENTA Y DATOS, S.A. DE C.V. Domicilio: 29 SUR 721 COL. LA PAZ 72160 PUEBLA, PUE. Tel: 01(52).222.891.55.77 CON 10 LINEAS E-Mail: <a href="mailto:datos@puebla.megared.net.mx">datos@puebla.megared.net.mx</a>	<b>Veracruz, Ver.:</b> CONEXION Y DESARROLLO, S.A DE C.V. Av. Americas # 419 ENTRE PINZÓN Y ALVARADO Fracc. Reforma C.P. 91919 Tel: 01-22-91-00-31-67 E-Mail: <a href="mailto:gacosta@qplus.com.mx">gacosta@qplus.com.mx</a>
<b>Chihuahua:</b> Soluciones Globales en Computación C. Magisterio # 3321 Col. Magisterial Chihuahua, Chih. Tel: 4136954 E-Mail: <a href="mailto:Cefeo@soluglobales.com">Cefeo@soluglobales.com</a>	<b>Cuernavaca:</b> Compusupport de Cuernavaca SA de CV Francisco Leyva # 178 Col. Miguel Hidalgo C.P. 62040, Cuernavaca Morelos Tel: 01 777 3180579 / 01 777 3124014 E-Mail: <a href="mailto:aquevedo@compusupportcva.com">aquevedo@compusupportcva.com</a>
<b>Distrito Federal:</b> QPLUS, S.A. de C.V. Av. Coyoacán 931 Col. Del Valle 03100, México, D.F. Tel: 01(52)55-50-00-27-35 E-Mail : <a href="mailto:gacosta@qplus.com.mx">gacosta@qplus.com.mx</a>	<b>Guadalajara, Jal.:</b> SERVICRECE, S.A. de C.V. Av. Niños Héroes # 2281 Col. Arcos Sur, Sector Juárez 44170, Guadalajara, Jalisco Tel: 01(52)33-36-15-15-43 E-Mail: <a href="mailto:mmiranda@servicrece.com">mmiranda@servicrece.com</a>
<b>Guerrero Acapulco:</b> GS Computación (Grupo Sesicomp) Progreso #6-A, Colo Centro 39300 Acapulco, Guerrero Tel: 744-48-32627	<b>Monterrey:</b> Global Product Services Mar Caribe # 1987, Esquina con Golfo Pérsico Fracc. Bernardo Reyes, CP 64280 Monterrey N.L. México Tel: 8129-5103 E-Mail: <a href="mailto:aydeem@gps1.com.mx">aydeem@gps1.com.mx</a>
<b>MERIDA:</b> ELECTROSER Av Reforma No. 403Gx39 y 41 Mérida, Yucatán, México CP97000 Tel: (52) 999-925-1916 E-Mail: <a href="mailto:rrrb@sureste.com">rrrb@sureste.com</a>	<b>Oaxaca, Oax.:</b> CENTRO DE DISTRIBUCION Y SERVICIO, S.A. de C.V. Murguía # 708 P.A., Col. Centro, 68000, Oaxaca Tel: 01(52)95-15-15-22-22 Fax: 01(52)95-15-13-67-00 E-Mail: <a href="mailto:gpotai2001@hotmail.com">gpotai2001@hotmail.com</a>
<b>Tijuana:</b> STD Av Ferrocarril Sonora #3780 L-C Col 20 de Noviembr Tijuana, Mexico	<b>FOR USA SUPPORT:</b> ViewSonic® Corporation 381 Brea Canyon Road, Walnut, CA. 91789 USA Tel: 800-688-6688 E-Mail: <a href="http://www.viewsonic.com">http://www.viewsonic.com</a>



**ViewSonic®**