

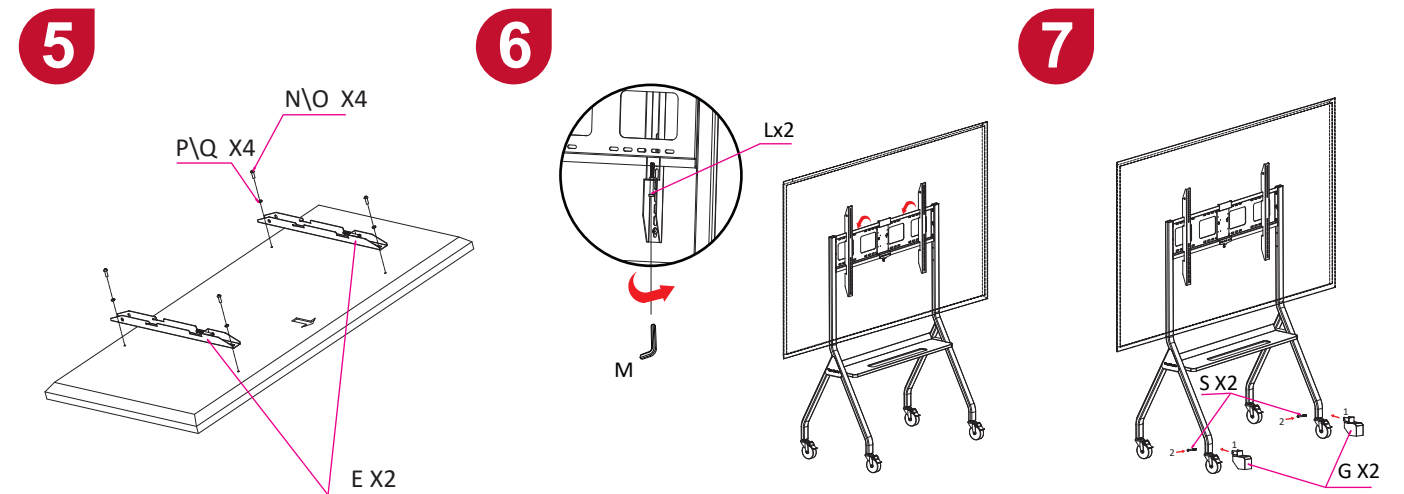

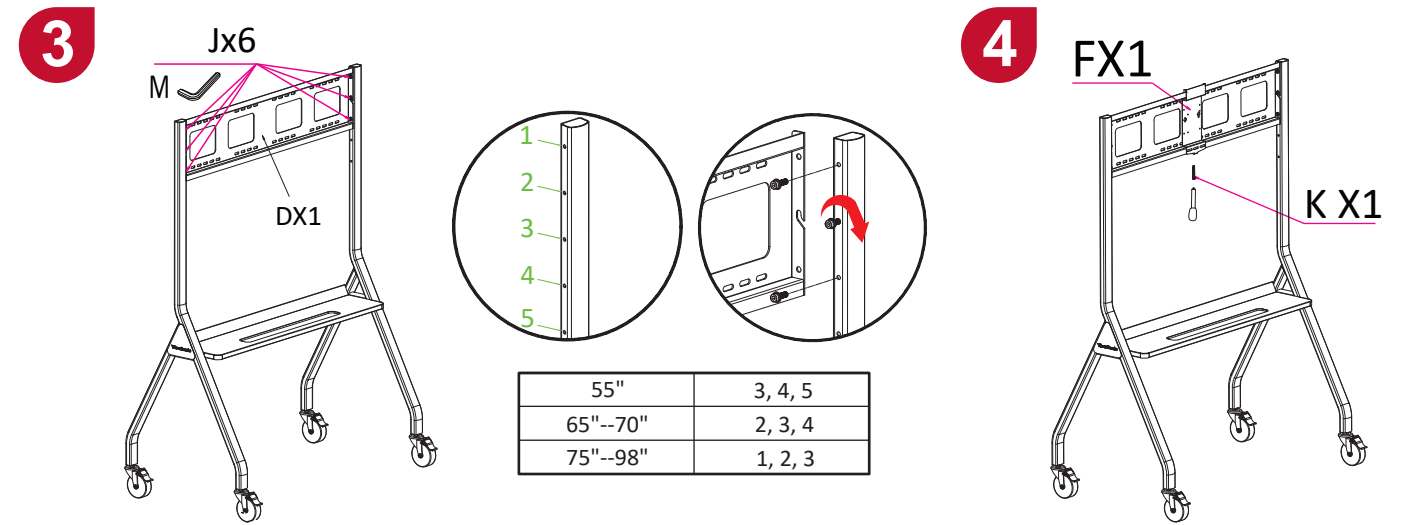

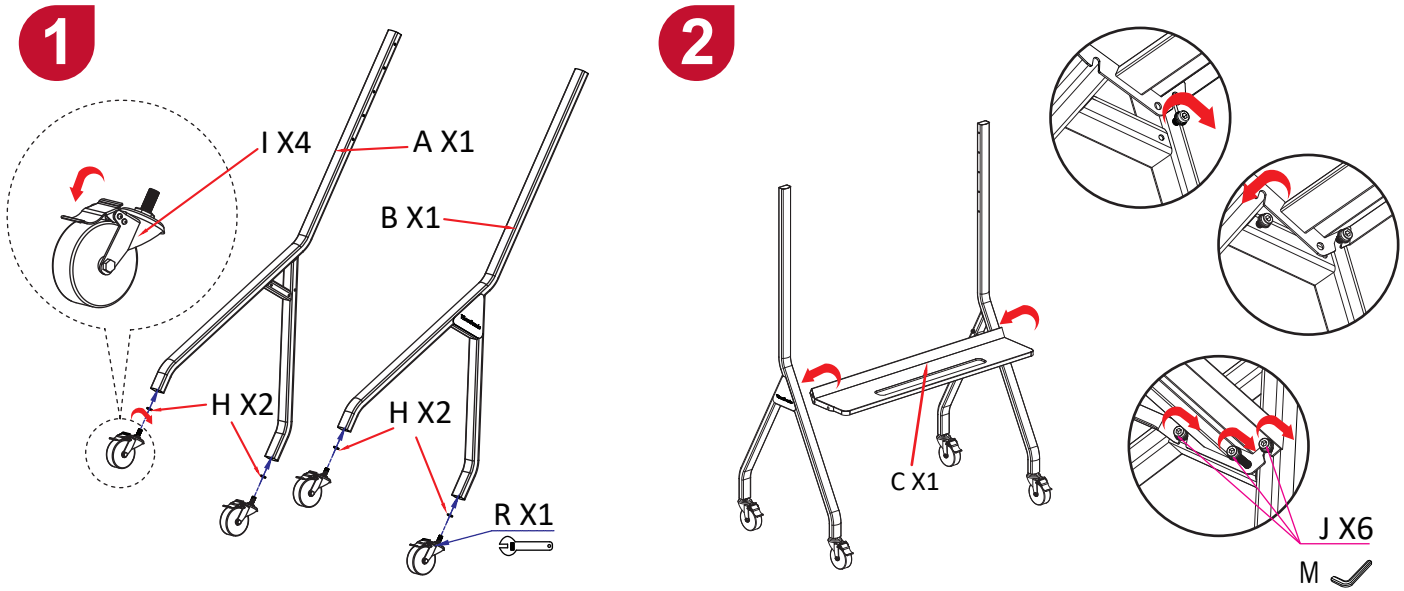







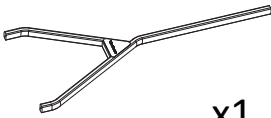
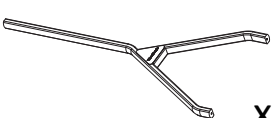
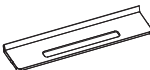
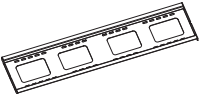

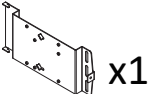



VB-STND-005 Safety Instruction Quick Start Guide





VB-STND-005 Safety Instruction Quick Start Guide

8

A  x1		B  x1		C  x1	
D  x1		E  x2		F  x1	G  x2
H  x4 (Ø20xØ13)	I  x4	J  x12 (M8X25)	K  x1 (M5X45)	L  x2 (M8X70)	M  x1 (M8)
N  x4 (M8X25)	O  x4 (M6X25)	P  x4 (Ø16xØ8.5)	Q  x4 (Ø13xØ6.5)	R  x1	S  x2 (M8X60)

i

Country/ Region	Website/Phone	Country/ Region	Website/Phone
Asia Pacific & Africa			
Australia	www.viewsonic.com/au/	Bangladesh	www.viewsonic.com/bd/
中国 (China)	www.viewsonic.com.cn 4008 988 188	香港 (繁體中文)	www.viewsonic.com/hk/
Hong Kong (English)	www.viewsonic.com/hk-en/	India	www.viewsonic.com/in/
Indonesia	www.viewsonic.com/id/	Israel	www.viewsonic.com/il/
日本 (Japan)	www.viewsonic.com/jp/	한국	www.viewsonic.com/kr/
Malaysia	www.viewsonic.com/my/	Middle East	www.viewsonic.com/me/
Myanmar	www.viewsonic.com/mm/	Nepal	www.viewsonic.com/np/
New Zealand	www.viewsonic.com/nz/	Pakistan	www.viewsonic.com/pk/
Philippines	www.viewsonic.com/ph/	Singapore	www.viewsonic.com/sg/
臺灣 (Taiwan)	www.viewsonic.com/tw/	ประเทศไทย	www.viewsonic.com/th/
Việt Nam	www.viewsonic.com/vn/	South Africa & Mauritius	www.viewsonic.com/za/
Americas			
United States	www.viewsonic.com/us 1-800-688-6688	Canada	www.viewsonic.com/us 1-866-463-4775
Latin America	www.viewsonic.com/la		
Europe			
Europe	www.viewsonic.com/eu/ +49-0821-45057383	France	www.viewsonic.com/fr/
Deutschland	www.viewsonic.com/de/	Қазақстан	www.viewsonic.com/kz/
Россия	www.viewsonic.com/ru/	España	www.viewsonic.com/es/
Türkiye	www.viewsonic.com/tr/	Україна	www.viewsonic.com/ua/
United Kingdom	www.viewsonic.com/uk/		

⚠ WARNING

- ⚠ WARNING - For use with televisions weighing 242.5 lbs (110 Kg) & Max 98" Monitor or less, Pallet load shall not exceed 22 lbs (10KG). Use with heavier televisions may result in instability causing tip over resulting in death or serious injury.
- ⚠ WARNING – Risk of death or serious injury. For use with TVs 1-3 inches thick.
- ⚠ WARNING -Death or serious injury may occur when children climb on audio and/or video equipment furniture. A remote control or toys placed on the furnishing may encourage a child to climb on the furnishing and as a result the furnishing may tip over on to the child.
- ⚠ WARNING -Relocating audio and/or video equipment to furniture not specifically designed to support audio and/or video equipment may result in death or serious injury due to the furnishing collapsing or over turning onto a child.

ViewSonic Corporation

14035 Pipeline Ave. Chino, CA91710, USA ViewSonic Europe Ltd.
1st Floor, Salamanca Place, 9 Albert Embankment, London SE1 7SP,
United Kingdom Corporate names, trademarks stated herein are
the property of their respective companies.
Copyright ©2020 ViewSonic Corporation. All rights reserved.
www.viewsonic.com

