

























Legenda

-  Code
-  Ratio
-  Screen size (AxB)
-  Viewing size / inches (A'xB'/O")
-  Viewing size (A'xB')
-  Total screen size (WxH)
-  Total size closed
-  Min-max total size
-  Screen case size
-  Counterweight size
-  Top extra drop
-  Max extra top drop
-  Lumens
-  Max load
-  Distance
-  Run
-  Fixing
-  Arm
-  Tilt
-  Joints
-  Pieces
-  Cable management
-  Volume
-  Projector case
-  Packing
-  Net weight
-  Gross weight

ORION KING PROJECTION SCREENS

on tripod, with anti-keystone effect system

PROJECTION

Great stability and sturdy portable projection screen, ideal for daily professional use. With their reliable mechanical retraction, wide and sturdy tripod and painted steel housing, the "ORION KING" screens are suitable for use in commercial environments, hotels, meeting facilities and training centres.

Technical features

- **Screens** made of MATT WHITE fabric (see technical data sheet at pages 1-2-3)
- **Four black borders 3 cm**, standard on all proposed format, to increase the projected image definition.
- **Steel housing** 2 mm thickness Hexagonal section, very sturdy structure, Epoxy powder coated, glossy black colour, detachable; closing ends of the housing case made of robust ABS
- **Sturdy tripod in black varnished steel**, 360° rotation for optimal positioning in the smallest possible space, complete with moplen anti-slip, square section support tube, perforated at 70, 99, 105, 113, 133,5 and 144 cm to enable different screen positioning heights
- **Anti-keystone effect** projection screen tilting system (max. 15°)

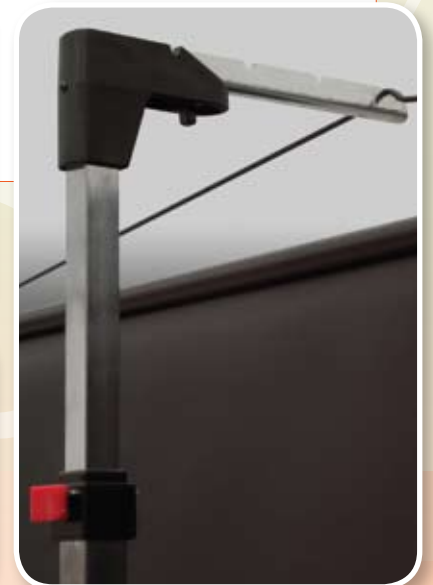
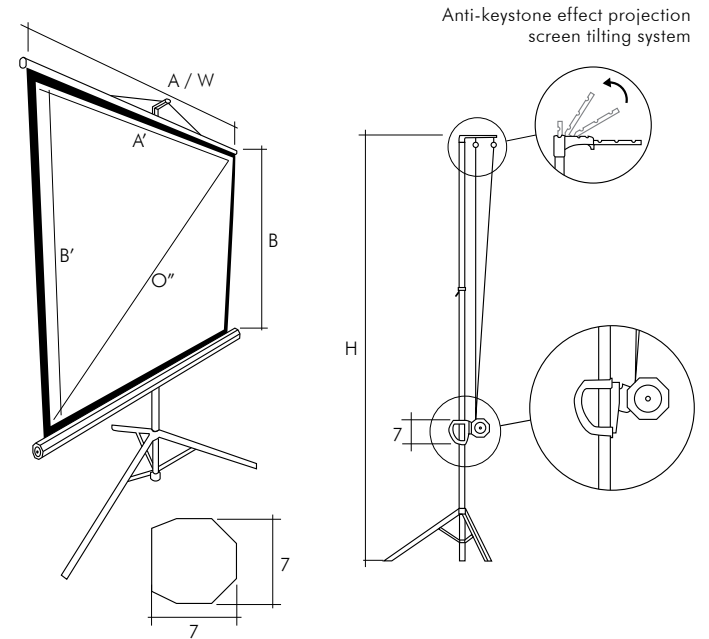

The anti-keystone effect projection screen tilting system, the tripod close up, the handle with release snap to raise and lower the screen

Barcode	Code	Ratio	Screen size (AxB)	Viewing size / inches (A'xB'/O")	Viewing size (A'xB')	Total screen size (WxH)	Total size closed
	012683 ORION KING 150	1:1	150x150	144x144/60"	170x22,5x15	10	12
	012883 ORION KING 180	1:1	180x180	174x174/70"	201x22,5x15	12	14
	013083 ORION KING 213	1:1	213x213	207x207/84"	233x22,5x15	13	16
	014083 ORION KING 244	1:1	244x244	238x238/96"	265x22,5x15	14	18

Size, in cm, weights expressed in kilograms, diagonal expressed in inches (")