

























## Legenda









-  Code
-  Ratio
-  Screen size (AxB)
-  Viewing size / inches (A'xB'/'O")
-  Viewing size (A'xB')
-  Total screen size (WxH)
-  Total size closed
-  Min-max total size
-  Screen case size
-  Counterweight size
-  Top extra drop
-  Max extra top drop
-  Lumens
-  Max load
-  Distance
-  Run
-  Fixing
-  Arm
-  Tilt
-  Joints
-  Pieces
-  Cable management
-  Volume
-  Projector case
-  Packing
-  Net weight
-  Gross weight

# CINEDOMUS PROJECTION SCREENS

with electrical command, varnished aluminium case

PROJECTION



									
<b>"CINEDOMUS" PROJECTION SCREENS WITH BLACK BORDERS, EXTRA DROP, VIDEO RATIO 4:3</b>									
<b>452784</b>	<b>CINEDOMUS 160x140</b>	160x140	150x113/74"	20	192x11x9	223x14,5x14	9	11	
<b>452884</b>	<b>CINEDOMUS 180x153</b>	180x153	170x128/84"	20	212x11x9	242x14,5x14	10	12	
<b>452984</b>	<b>CINEDOMUS 200x168</b>	200x168	190x143/94"	20	232x11x9	261x14,5x14	12	14	
<b>453684</b>	<b>CINEDOMUS 220x183</b>	220x183	210x158/104"	20	252x11x9	278x14,5x14	13	16	
<b>453884</b>	<b>CINEDOMUS 240x198</b>	240x198	230x173/113"	20	272x11x9	298x14,5x14	14	17	
<b>454184</b>	<b>CINEDOMUS 260x198</b>	260x213	250x188/123"	20	292x11x9	306x14,5x14	16	19	
<b>454384</b>	<b>CINEDOMUS 280x228</b>	280x228	270x203/133"	20	312x11x9	338x14,5x14	17	20	
<b>457684</b>	<b>CINEDOMUS 300x243</b>	300x243	290x218/143"	20	332x11x9	358x14,5x14	17	20	
<b>"CINEDOMUS" PROJECTION SCREENS WITH BLACK BORDERS, EXTRA DROP, HDTV RATIO 16:9</b>									
<b>452484</b>	<b>CINEDOMUS 160x140</b>	160x140	150x85/68"	50	192x11x9	223x14,5x14	9	11	
<b>452384</b>	<b>CINEDOMUS 180x151</b>	180x151	170x96/77"	50	212x11x9	242x14,5x14	10	12	
<b>453184</b>	<b>CINEDOMUS 200x162</b>	200x162	190x107/86"	50	232x11x9	261x14,5x14	11	13	
<b>453484</b>	<b>CINEDOMUS 220x173</b>	220x173	210x118/95"	50	252x11x9	278x14,5x14	13	16	
<b>453584</b>	<b>CINEDOMUS 240x185</b>	240x185	230x130/104"	50	272x11x9	298x14,5x14	14	17	
<b>453984</b>	<b>CINEDOMUS 260x196</b>	260x196	250x141/113"	50	292x11x9	306x14,5x14	16	19	
<b>457284</b>	<b>CINEDOMUS 280x207</b>	280x207	270x152/122"	50	312x11x9	338x14,5x14	16	19	
<b>457384</b>	<b>CINEDOMUS 300x218</b>	300x218	290x163/131"	50	332x11x9	358x14,5x14	18	21	
<b>"CINEDOMUS" PROJECTION SCREENS WITH BLACK BORDERS, SQUARE RATIO 1:1</b>									
<b>452683</b>	<b>CINEDOMUS 150x150</b>	150x150	140x140/78"	5	182x11x9	208x14,5x14	10	12	
<b>452883</b>	<b>CINEDOMUS 180x180</b>	180x180	170x170/94"	5	212x11x9	242x14,5x14	11	13	
<b>453283</b>	<b>CINEDOMUS 200x200</b>	200x200	190x190/105"	5	232x11x9	258x14,5x14	12	15	
<b>454083</b>	<b>CINEDOMUS 250x250</b>	250x250	240x240/133"	5	282x11x9	307x14,5x14	15	18	
<b>"CINEDOMUS" PROJECTION SCREENS WITHOUT BLACK BORDERS, VIDEO RATIO 4:3</b>									
<b>453843</b>	<b>CINEDOMUS 250x190</b>	250x190	250x190/123"	-	282x11x9	307x14,5x14	14	17	
<b>457643</b>	<b>CINEDOMUS 300x225</b>	300x225	300x225/147"	-	332x11x9	358x14,5x14	17	20	
<b>"CINEDOMUS" PROJECTION SCREENS WITHOUT BLACK BORDERS, SQUARE RATIO 1:1</b>									
<b>452643</b>	<b>CINEDOMUS 150x150</b>	150x150	150x150/83"	-	182x11x9	208x14,5x14	10	12	
<b>452843</b>	<b>CINEDOMUS 180x180</b>	180x180	180x180/100"	-	212x11x9	242x14,5x14	11	13	
<b>453243</b>	<b>CINEDOMUS 200x200</b>	200x200	200x200/111"	-	232x11x9	258x14,5x14	12	15	
<b>454043</b>	<b>CINEDOMUS 250x250</b>	250x250	250x250/139"	-	282x11x9	307x14,5x14	15	18	
<b>ACCESSORIES AND SPARE PARTS</b>									
<b>090015</b>	REMOTE RADIO CONTROL HOME (receiver + transmitter) working range 60 meters						0,60	-	
<b>090006</b>	INVERTER fixed positions, stop button, mounting to bump						0,10	-	
<b>090007</b>	PAIR OF SUSPENSION BRACKETS (besides those standard supplied)						0,25	-	

Size, in cm, weights expressed in kilograms, diagonal expressed in inches (")

# CINEDOMUS PROJECTION SCREENS

## with electrical command, varnished aluminium case

CINEDOMUS is the new range of professional electrical screens, developed and designed mainly for domestic use in home cinemas, but also suitable for any kind of use. Sober design: a sturdy aluminium structure and the total absence of visible screws: the attention to details, the materials used and the construction quality are the common denominators of this product. Operation is quick and silent thanks to the 28 RPM motor, guaranteed for 5 years. The most outstanding aspect is without a doubt the use of the Matt White fabric that, thanks to its stability and planarity, guarantees the to-

tal absence of waves, curls and, most importantly, horrible welds on large formats: the rear black side eliminates any possible interference caused by light sources positioned behind the screen; the outer black borders are decorated with a serigraphy process using a special indelible ink that is resistant to fabric creases that may occur during the rolling phase. Easy wall or ceiling fixing using suspension brackets for free positioning along the length of the case, the CINEDOMUS screens can be fitted, upon request, with remote controls and therefore guarantee the utmost comfort in use.

### Technical Features

- **Screens** realised with the following projection fabrics: MATT WHITE (see technical data sheet at pages 1-2-3)
- **Available** in square format 1:1, video 4:3 and also HDTV 16:9, **supplied with or without four black outer borders of 5 cm and an extra upper black drop** which changes according to the format: the black outer borders increase the definition of the image projected on the screen
- **All screens** in the proposed formats **do not present welding on the projection surface**
- **The screen has to be lowered from the rear side of the box**, it can not be provided with front lowering system; in the case of a wall mounted installation, the screen lowers at 29-45mm from the wall
- **Robust case of extruded aluminium, epoxide powder coating, in white RAL 9010 colour**, section 85x93 mm, with rounded corners; provided with reinforcement on the back side to hold wall **fixing clamps**; on the lower side a longitudinal slot with **rounded edges** allows the descend of the projection screen.
- **Internal anodized aluminium tube for fabric wind up**  $\varnothing$  50 mm, which includes a reliable robust electric motor mounted on special rubber silent blocks.
- **Electric single-phase motor**, CE mark, **5 years warranty** from

the purchase date, electrical connections 200V - 50Hz, absorption 0,66A, protection IP 44, 28 RPM; in the standard version the motor is fixed to the right hand side

- **Screen up and down electric inverter, standard supplied**
- **Screen up and down limit switches factory adjusted**, possibility of different settings if necessary. The screen can also be stopped at intermediate height by pressing the electric inverter switch
- **Suspension brackets are standard supplied** and can be mounted anywhere along the whole housing length. Brackets are steel made, **epoxy powder coated in white RAL 9010 colour**, they are suitable both for wall or ceiling installation thanks specific expansion anchors
- **Rounded closing heads of the box**, with a special design made from shockproof ABS in **white RAL 9010**
- **The lower bar has a pleasant drop shape** form and it is complete with white ABS end caps
- **Supplied in robust double cardboard package** (vulcano type)
- **Product CE certified**, 12 month warranty to the conditions indicated on the manual
- **Accessories on request**: radio remote control
- **Overall dimensions**: screen dimension +18 cm

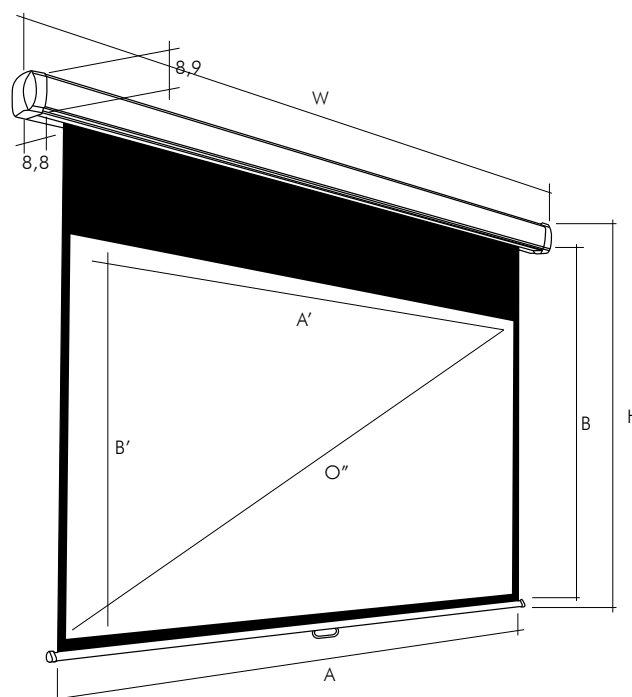

PROJECTION

### Legenda

- Code
- Ratio
- Screen size (AxB)
- Viewing size / inches (A'xB'/O'')
- Viewing size (A'xB')
- Total screen size (WxH)
- Total size closed
- Min-max total size
- Screen case size
- Counterweight size
- Top extra drop
- Max extra top drop
- Lumens
- Max load
- Distance
- Run
- Fixing
- Arm
- Tilt
- Joints
- Pieces
- Cable management
- Volume
- Projector case
- Packing
- Net weight
- Gross weight