

User Manual

AMV-340 40 Watt Power Amplifier



All Rights Reserved

Version: AMV-340_2017V1.0

Preface

Read this user manual carefully before using the product. Pictures shown in this manual is for reference only, different model and specifications are subject to real product.

This manual is only for operation instruction only, not for any maintenance usage. The functions described in this version are updated till November 3, 2017. In the constant effort to improve our product, we reserve the right to make functions or parameters changes without notice or obligation. Please refer to the dealers for the latest details.

Trademarks

Product model, and logo are trademarks. Any other trademarks mentioned in this manual are acknowledged as the properties of the trademark owner. No part of this publication may be copied or reproduced without prior written consent.

FCC Statement

This equipment generates, uses and can radiate radio frequency energy and, if not installed and used in accordance with the instructions, may cause harmful interference to radio communications. It has been tested and found to comply with the limits for a Class B digital device, pursuant to part 15 of the FCC Rules. These limits are designed to provide reasonable protection against harmful interference in a commercial installation.

Operation of this equipment in a residential area is likely to cause interference, in which case the user at their own expense will be required to take whatever measures may be necessary to correct the interference.

Any changes or modifications not expressly approved by the manufacture would void the user's authority to operate the equipment.



SAFETY PRECAUTIONS

To insure the best from the product, please read all instructions carefully before using the device. Save this manual for further reference.

- Unpack the equipment carefully and save the original box and packing material for possible future shipment
- Follow basic safety precautions to reduce the risk of fire, electrical shock and injury to persons.
- Do not dismantle the housing or modify the module. It may result in electrical shock or burn.
- Using supplies or parts not meeting the products' specifications may cause damage, deterioration or malfunction.
- Refer all servicing to qualified service personnel.
- To prevent fire or shock hazard, do not expose the unit to rain, moisture or install this product near water.
- Do not put any heavy items on the extension cable in case of extrusion.
- Do not remove the housing of the device as opening or removing housing may expose you to dangerous voltage or other hazards.
- Install the device in a place with fine ventilation to avoid damage caused by overheat.
- Keep the module away from liquids.
- Spillage into the housing may result in fire, electrical shock, or equipment damage. If an object or liquid falls or spills on to the housing, unplug the module immediately.
- Do not twist or pull by force ends of the optical cable. It can cause malfunction.
- Do not use liquid or aerosol cleaners to clean this unit. Always unplug the power to the device before cleaning.
- Unplug the power cord when left unused for a long period of time.
- Information on disposal for scrapped devices: do not burn or mix with general household waste, please treat them as normal electrical wastes.

Table of Contents

1. Introduction	1
1.1 Introduction to AMV-340	1
1.2 Features	1
1.3 Package List	2
2. Panel Description	3
2.1 Front Panel	3
2.2 Rear Panel	4
3. System Connection	5
3.1 Usage Precaution	5
3.2 System Diagram	5
3.3 Audio Signal Connection	5
3.3.1 Audio Output	5
3.3.2 Audio Input	6
3.4 System Application	7
4. System Operations	8
4.1 Operations of Front Panel	8
4.1.1 Audio Switching	8
4.1.2 Volume/EQ Controlling	8
4.2 Operations of IR Remote	9
4.3 Operations of Control Software	10
4.3.1 Connection with Computer	10
4.3.2 RS232 Control Software	10
4.3.3 Running Environment	10
4.3.4 Function Setting	11
4.3.5 RS232 Command	12
5. Specifications	14
6. Panel Drawing	15
7. Troubleshooting and Maintenance	16
8. Customer Service	17

1. Introduction

1.1 Introduction to AMV-340

AMV-340 is a 40 Watt Power Amplifier (Class-D) with output alternatively at 70V or 100V. It has 2 stereo inputs (1x3.5mm jack for line in, 2xRCA for L&R), 1 digital input & 1 balanced MIC. It is integrated with powerful functions, including ducking function, EQ control, MIC mixer etc, and MIC input supports 3 levels with condenser MIC, dynamic MIC & line audio input.

As for power amplifier we have normally voltages at 70V and 100V for different countries, but AMV-340 is designed to integrate with both voltages to meet different requirements.

1.2 Features

- Mono audio output at 40Watt.
- Switchable between 70V and 100V.
- Ducking function.
- 16 ID codes for controlling between different AMV-340 amplifiers.
- 3-level MIC input, supports condenser microphone, dynamic microphone and wireless microphone.
- MIC port can support balance/unbalance signal, suppress the external noise effectively.
- Two stereo audio inputs and one digital audio input, switchable by button, IR remote & RS232.
- Volume/Bass/Treble controllable by buttons, IR remote & RS232.
- Fast switching speed for good performance.
- Convection cooler, fan is not needed.
- LED indicator, for power and working status.
- Antistatic case design to provide good protection for long-term and stable performance.

1.3 Package List

- 1 x AMV-340
- 2 x Mounting Ears
- 4 x Screws
- 1 x Pluggable Terminal Block
- 1 x RS232 Cable
- 1 x Power Adapter (DC 24V)
- 1 x Power Cord
- 4 x Plastic Cushions
- 1 x User Manual

Note: Ensure the product and the accessories are all included, if not, please contact with the dealers.

2. Panel Description

2.1 Front Panel

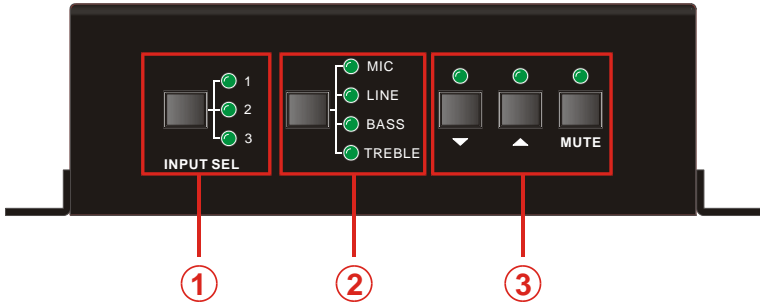

Figure 1 Front Panel

No.	Name	Function
①	Audio Input Selection	To select the input audio source, after choosing the audio source, the corresponding LED indicator will be on. No.1 is for dual mono audio input (2 RCA connectors for L&R), No.2 is for stereo audio input (3.5mm mini jack), and No.3 is for digital fiber audio input.
②	Audio Control	Adjust the volume of the MIC, Line, or the level of Bass and Treble with this button
③	Volume Adjustment	To turn up/down or mute the corresponding audio. ▽ : Turn down the volume △ : Turn up the volume MUTE: Mute the output

2.2 Rear Panel

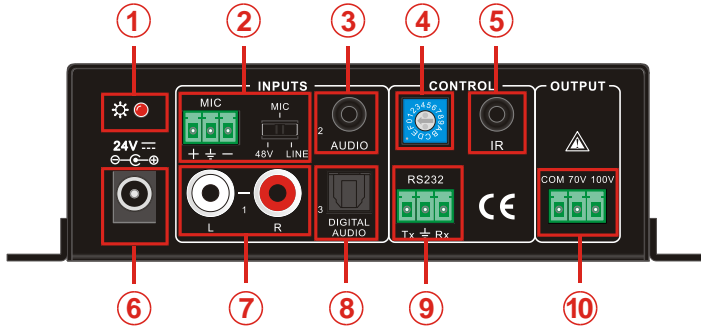

Figure 2 Rear Panel

No.	Name	Function
①	Power Indicator	Turns red when power on.
②	Microphone input port	3-pole captive screw connector for microphone input, the dial switch in right side is to select the micro input kind, including 48V (for condenser microphone), MIC (for dynamic microphone) and LINE (for line audio).
③	Audio Inputs	3.5mm mini jack for stereo audio input, it can be connected with audio source device such as DVD player.
④	ID Code	16 codes range from 0 to F (hexadecimal), works together with the PC control software.
⑤	IR	To connect with the IR receiver, works together with the IR remote.
⑥	Power Port	To connect with the power adapter (DC24V).
⑦	2 x RCA	Dual-mono audio input, which can be connected with audio source device such as a PC.
⑧	Digital Audio Input	Fiber connector for digital audio input (PCM format only), it can be connected with a device with fiber port, such as blue-ray player.
⑨	RS232	3-pole captive screw connector for serial control, it can be connected with PC (Use a 3-pole captive to 9 pin female D connector and serial control software) to control AMV-340.
⑩	Audio Output	To connect with audio output devices, such as speakers (To select 70V or 100V depends on the input voltage of the speakers). COM is for grounding (GND).

3. System Connection

3.1 Usage Precaution

- Verify all components and accessories included before installation.
- System should be installed in a clean environment with proper temperature and humidity.
- All of the power switches, plugs, sockets and power cords should be insulated and safe.
- All devices should be connected before power on.

3.2 System Diagram

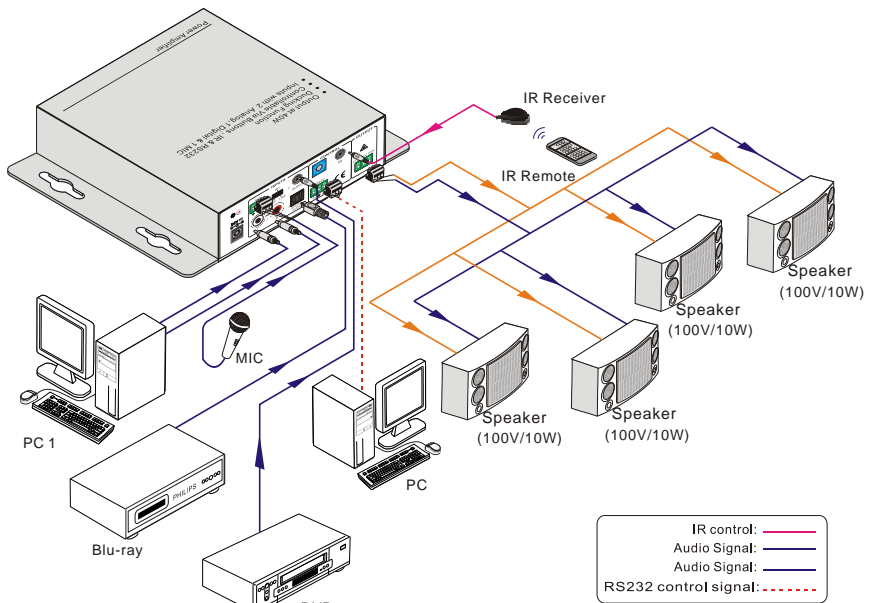

Figure 3 System Diagram

3.3 Audio Signal Connection

3.3.1 Audio Output

AMV-340 supports mono audio output, and the output voltage is 70V or alternative 100V. With its dual-purpose design, it can be applied in different areas. The end COM is for grounding. The amplifier to be connected is mono audio output with a rated power at 40Watt, so AMV-340 can be connected with several speakers in parallel connection way

(Total power mustn't be more than 40Watt).

The following figure shows us how to connect with the speakers. Here we take the 100V/10W speakers for each as example.

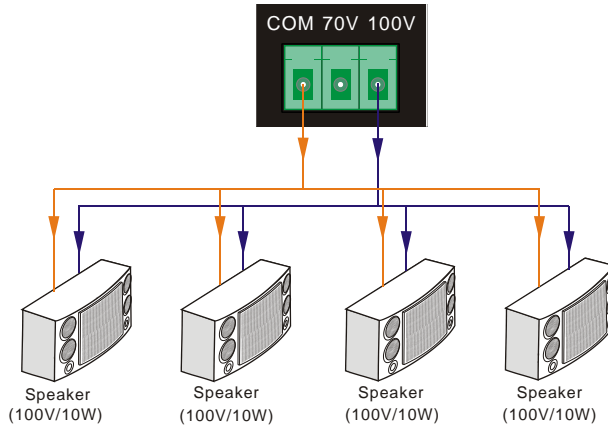

Figure 4 Audio Output Connection

Note: Speakers to be connected should be with constant pressure.

3.3.2 Audio Input

AMV-340 provides with 2 stereo audio inputs, one microphone input and one digital fiber audio input. The following figure shows the audio input ports.

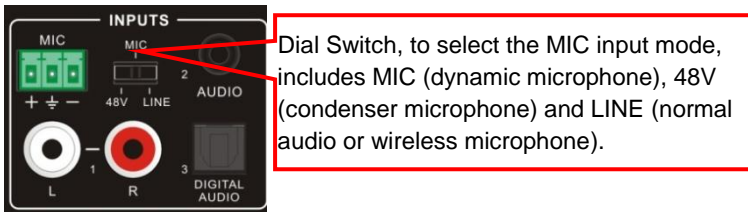

Figure 5 Audio Input Ports

➤ 48V phantom power input

When the switch turns to "48V" (It has a good frequency characteristic, high input impedance and high sensitivity in this mode), the MIC input will provide a 48V phantom power. This is usually used for power supply for condenser microphone, Connection is: "+" connects to positive, "-" connects to negative and "⏏" to ground.

Note: In this mode, only condenser microphone can be connected with.

➤ MIC input

When the switch turns to "MIC" (It has a low frequency characteristics, and wide frequency response in this mode), the microphone input is used for connecting with dynamic microphone. There are two different connections:

a) Unbalanced connection:

"+" and "" connect to ground, and "-" connects to signal.

"-" and "" connect to ground, and "+" connects to signal.

b) Balanced connection: "+" connects to positive, "-" connects to negative and "" connects to ground.

➤ LINE input

When the switch turns to "LINE" (It has a low frequency characteristics, and wide frequency response in this mode), the microphone input is used for connecting with normal audio or wireless microphone output. There are two different connections:

a) Unbalanced connection:

"+" and "" connect to ground, and "-" connects to signal.

"-" and "" connect to ground, and "+" connects to signal.

b) Balanced connection: "+" connects to positive, "-" connects to negative and "" connects to ground.

➤ Digital audio input

The AMV-340 provides with a fiber optical port to connect with digital audio source device. With the SPF optical fiber, the audio signal can be transmitted faster, more stable, reliable, and can be transmitted over a long distance without distortion.

Note: This digital audio input can support/decode PCM format signal only. If the CD/DVD is DTS or AC3 format, please set the player to PCM format output before connect to AMV-340.

3.4 System Application

AMV-340 can be applied in different occasions, such as classroom, small meeting room, lecture hall, bar and hotel etc.

4. System Operations

4.1 Operations of Front Panel

The buttons provides the control of volume/EQ control and switching. The LED indicator will show the connecting status. The following content introduces audio switching and EQ control in detail.

Operations: Press the corresponding button again for cyclic switching.

4.1.1 Audio Switching

There are three switchable audio inputs, one 2xRCA input, one 3.5mm jack input, and one digital fiber audio input, switchable through the buttons as below:

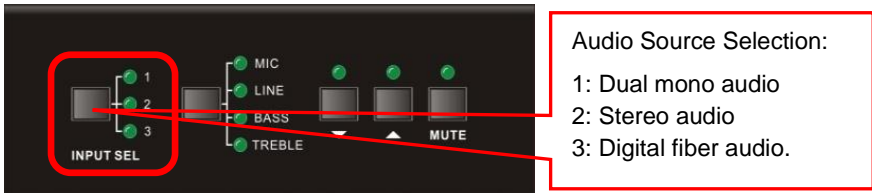

Figure 6 Audio Source Selection Button

4.1.2 Volume/EQ Controlling

The line volume and MIC volume can be controlled by the buttons.

The MIC Volume/LINE volume/LINE bass/LINE treble will be selected by the buttons, and controlled up/down/mute by the function buttons. Please check the picture below:

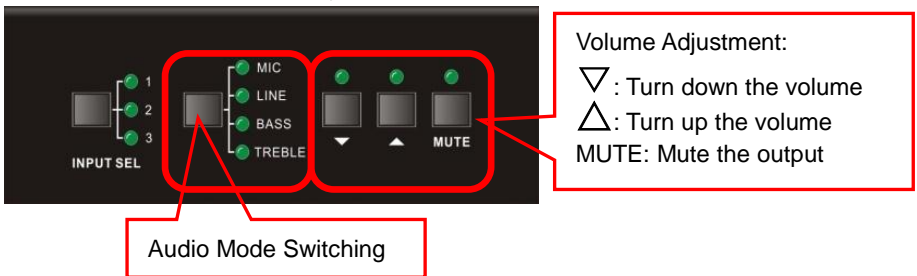

Figure 7 Audio Mode and Volume Adjustment buttons

For example, to turn up the line volume, you should select the “LINE” first, and then press the button “▲”.

4.2 Operations of IR Remote

AMV-340 provides with an IR eye, with the IR Receiver and the IR remote, user can control AMV-340 remotely.

Note: The IR Receiver and the IR remote are all offered for charge.

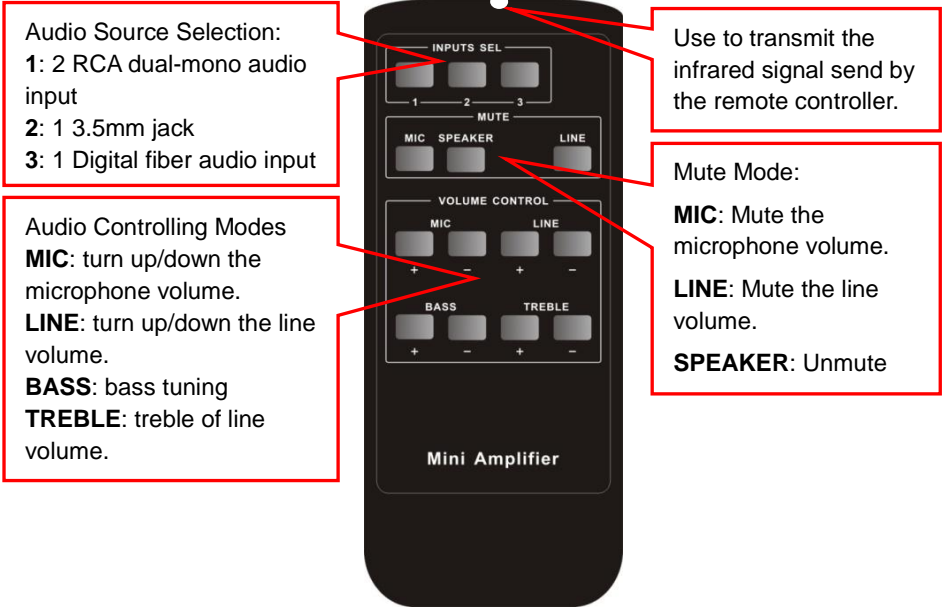

Figure 8 IR Remote



Figure 9 IR Receiver

4.3 Operations of Control Software

4.3.1 Connection with Computer

When the amplifier connects to the COM1 or COM2 of the computer with control software, users can control it by that computer.

To control the amplifier, users should use a 3-pole male captive screw to 9-pin HD female connector and use the public COM software.

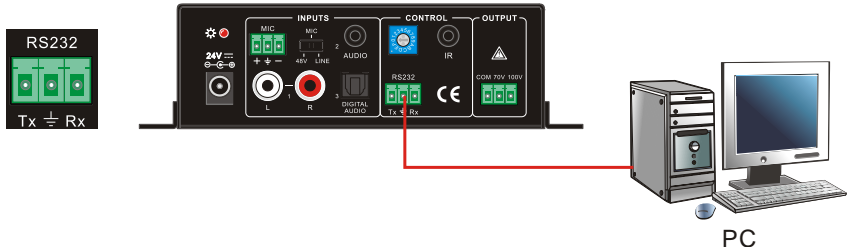

Figure 10 Connection of RS232 Port

4.3.2 RS232 Control Software

➤ Installation

- Connect the input source devices and the output device according to the system diagram.
- Copy the RS232 control software to one computer, and then connect the RS232 port of this computer and AMV-340.
- Double-click the EXE program to execute the software.

Here we take the software **CommWatch.exe** as example. The icon is showed as below:



Figure 11 Control Software

➤ Uninstallation

Delete all the control software files in corresponding file path.

4.3.3 Running Environment

While the control software is installed, we can activate the software through the RS232 port and set the parameters, to make it able to send RS232 commands to control AMV-340.

4.3.4 Function Setting

With the control software, we can easily switch the input channel, mute the output, check the working status, and adjust the volume etc. Please refer the details in *RS232 Communication Commands*.

The interface of the control software is showed as below:

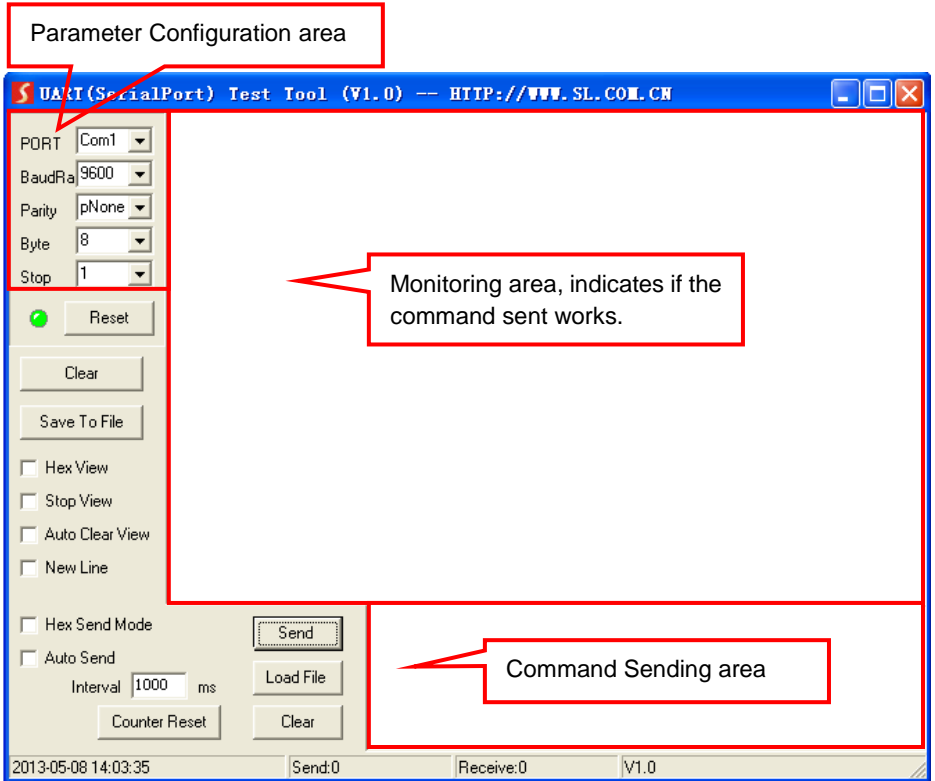

Figure 12 Main Interface of Control Software

4.3.5 RS232 Command

Communication Protocol: RS232 Communication Protocol

Baud rate: 9600

Data bit: 8

Stop bit: 1

Parity bit: none

Command	Description	Feedback Example
#RST!	Factory reset.	@RST:OK!
#RAV:[XX]A01!	Route audio input [XX] to output 01. [XX] =01 or 02 or 03.	@RAV:AUDIO 01 TO OUT 01!
#VOL:SRCMUTE!	Mute source audio (01 or 02 or 03).	@VOL:SRC MUTE!
#VOL:SRCUNMUTE!	Unmute source audio (01 or 02).	@VOL:SRC UNMUTE!
#VOL:SRCUP!	Volume up for source audio. XX=00~60	@VOL:SRC 30!
#VOL:SRCDN!	Volume down for source audio. XX=00~60	@VOL:SRC 30!
#VOL:SRC[XX]!	Set volume to [XX] for source audio. XX=00~60	@VOL:SRC 30!
#VOL:MICMUTE!	Mute microphone audio.	@VOL:MIC MUTE!
#VOL:MICUNMUTE!	Unmute microphone audio.	@VOL:MIC UNMUTE!
#VOL:MICUP!	Volume up for microphone audio. XX=00~60	@VOL:MIC 30!
#VOL:MICDN!	Volume down for microphone audio. XX=00~60	@VOL:MIC 30!
#VOL:MIC[XX]!	Set volume to [XX] for microphone audio.	@VOL:MIC 30!
#VOL:OUTMUTE!	Mute output audio (Speaker).	@VOL:OUT MUTE!
#VOL:OUTUNMUTE!	Unmute output audio (Speaker).	@VOL:OUT UNMUTE!
#VOL:BASUP!	Volume up for output audio. XX=00~08	@VOL:BAS 00!
#VOL:BASDN!	Volume down for output audio. XX=00~08	@VOL:BAS 00!
#VOL:BAS[XX]!	Set volume to [XX] for output audio. XX=00~08	@VOL:BAS 00!
#VOL:TREUP!	Volume up for output audio. XX=00~08	@VOL:TRE 00!
#VOL:TREDN!	Volume down for output audio. XX=00~08	@VOL:TRE 00!
#VOL:TRE[XX]!	Set volume to [XX] for output audio. XX=00~08	@VOL:TRE 00!
#VOL:GATEON!	Gate ON.	@VOL:GATE ON!
#VOL:GATEOFF!	Gate OFF.	@VOL:GATE OFF!
#VOL:DUCKINGON!	DUCKING ON.	@VOL:DUCKING ON!
#VOL:DUCKINGOFF!	DUCKING OFF.	@VOL:DUCKING OFF!

#VOL:DUCKING[XX]!	Set DUCKING level to XX. XX= 00~60.	@VOL:DUCKING 20!
#RPT:STATUS?!	Report status.	@RAV:AUDIO 01 TO OUT 01! @VOL:OUT UNMUTE! @VOL:SRC 30! @VOL:MIC MUTE! @VOL:MIC 46! @VOL:BAS 00! @VOL:TRE 00! @VOL:GATE OFF! @VOL:DUCKING ON! @VOL:DUCKING 20!

Note:

- The letter inside bracket [] is the variable code, which is changeable.
- The bracket [] is not included to the RS232 commands.
- Any dot “!” after the letters is part of the commands.

- **Ducking function:**

When input with MIC, the volume of the line audio will be automatically turned down to the preset volume level, if there is no input MIC audio signal after 5 seconds, then the volume will be automatically turned up to the original one. If you need to disable or enable the ducking function, just send the command “#VOL:DUCKINGOFF!” or “#VOL:DUCKINGON!”.

- **ID coding**

The ID codes of AMV-340 ranges from 0 to F (hexadecimal), when sending RS232 commands, please take notice of the address of the ID code.

If the address of the ID code is **0**, any RS232 command is available.

If the address is in **1~F**, it has one unique ID code (If the ID code is not the same with the address, no RS232 command will work).

While the ID code is in **1~F**, please add “**ID**” before sending the command.

For example:

Address = 0, code is “#VOL:OUTUP!”, feedback is “@VOL:OUT 30!”.

Address = 5, code is “#5/VOL:OUTUP!”, feedback is “@5/VOL:OUT 30!”.

5. Specifications

Audio Input	
Input	(2) stereo audio; (1) MIC; (1) Digital fiber audio
Input Connector	(2) RCA; (1) 3.5mm jack; (1) 3-pole 3.81mm captive screw connector; (1) SPF fiber connector
Input Impedance	>10K Ω
Audio Output	
Output	(1) mono amplifier
Output Connector	(1) 3-pole 3.81mm captive screw connector
Output Type	Constant voltage 70V or 100V.
Audio General	
Frequency Response	120Hz ~ 20KHz
CMRR	>70dB@20Hz~20KHz
SNR	80dB (Max)
Bandwidth	120Hz ~ 20KHz
Rated Power Output	40Watt
THD + Noise	1%@1KHz, 0.3%@20KHz at nominal level
Voltage Gain	26dB
Control Function	
RS232 Control	(1) 3-pole 3.81mm captive screw connector
Front Panel Control	buttons
ID Code Control	16 ID codes for control.
Optional	IR remote & TCP/IP controlled by programmable interface.
General	
Operation Temperature	-10 ~ +40 $^{\circ}$ C
Relative Humidity	10% ~ 90%
Power Supply	DC 24V 2.71A power adapter
Power Consumption	5W (standby mode)
Case Dimension	W130 x H44 x D144mm (1U high)
Net Weight	860g

6. Panel Drawing

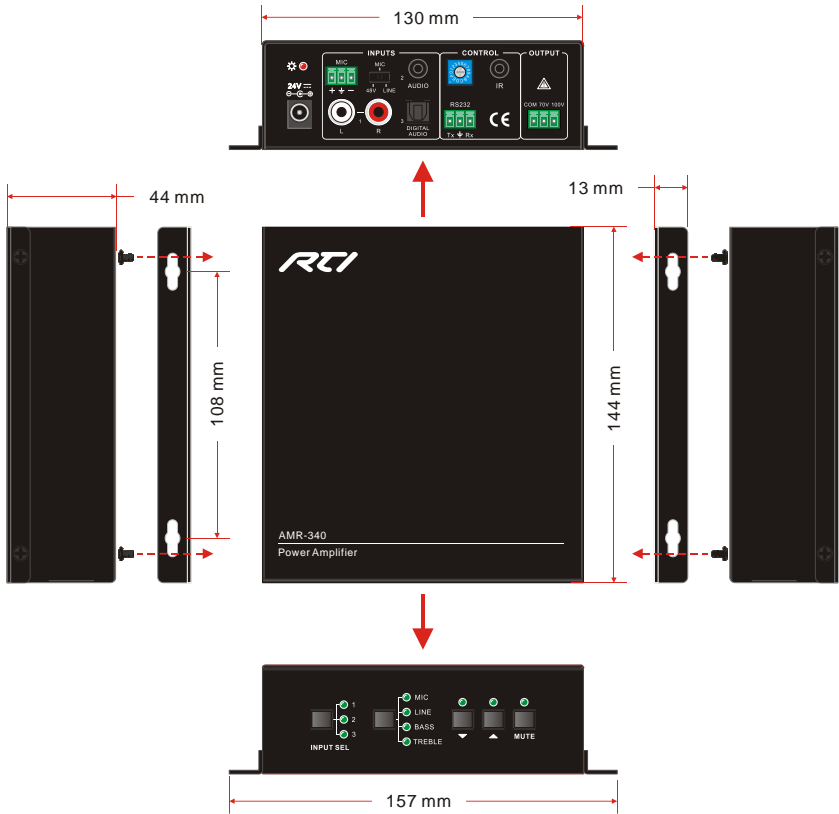

Figure 13 Panel Drawing

7. Troubleshooting and Maintenance

Problems	Potential Causes	Solutions
No output audio	No signal at input/ output end	Check input/ output signal by an oscilloscope or a multimeter.
	Failed cable connection	Change for another cable.
	Broken unit	Send it to the dealer for repairing.
POWER indicator doesn't work or no respond to any operation	Failed power connection	Make sure the power cord connection is good
Static becomes stronger when connecting the video connectors	Bad grounding	Check the grounding and make sure it is connected well.
Output audio is interfered		
Cannot control the device by front panel buttons, RS232 port or IR remote	Broken unit	Send it to the dealer for repairing.

If your problem persists after following the above troubleshooting steps, seek further help from authorized dealer or our technical support.

8. Customer Service

The return of a product to our Customer Service implies the full agreement of the terms and conditions hereinafter. These terms and conditions may be changed without prior notice.

1) Warranty

The limited warranty period of the product is fixed 3 (three) years.

2) Scope

These terms and conditions of Customer Service apply to the customer service provided for the products or any other items sold by authorized distributor only.

3) Warranty Exclusions:

- Warranty expiration.
- Factory applied serial number has been altered or removed from the product.
- Damage, deterioration or malfunction caused by:
 - ✓ Normal wear and tear.
 - ✓ Use of supplies or parts not meeting our specifications.
 - ✓ No certificate or invoice as the proof of warranty.
 - ✓ The product model showed on the warranty card does not match with the model of the product for repairing or had been altered.
 - ✓ Damage caused by force majeure.
 - ✓ Servicing not authorized by distributor.
 - ✓ Any other causes which does not relate to a product defect.
- Shipping fees, installation or labor charges for installation or setup of the product.

4) Documentation:

Customer Service will accept defective product(s) in the scope of warranty coverage at the sole condition that the defect has been clearly defined, and upon reception of the documents or copy of invoice, indicating the date of purchase, the type of product, the serial number, and the name of distributor.

Remarks: For further assistance or solutions, please contact your local distributor.



Remote Technologies Incorporated

5775 12th Avenue East, Suite 180

Shakopee, MN 55379

Tel: 952-253-3100

Fax: 952-253-3131

www.rticorp.com