

# > M2e

## LED Smart Theater User Guide

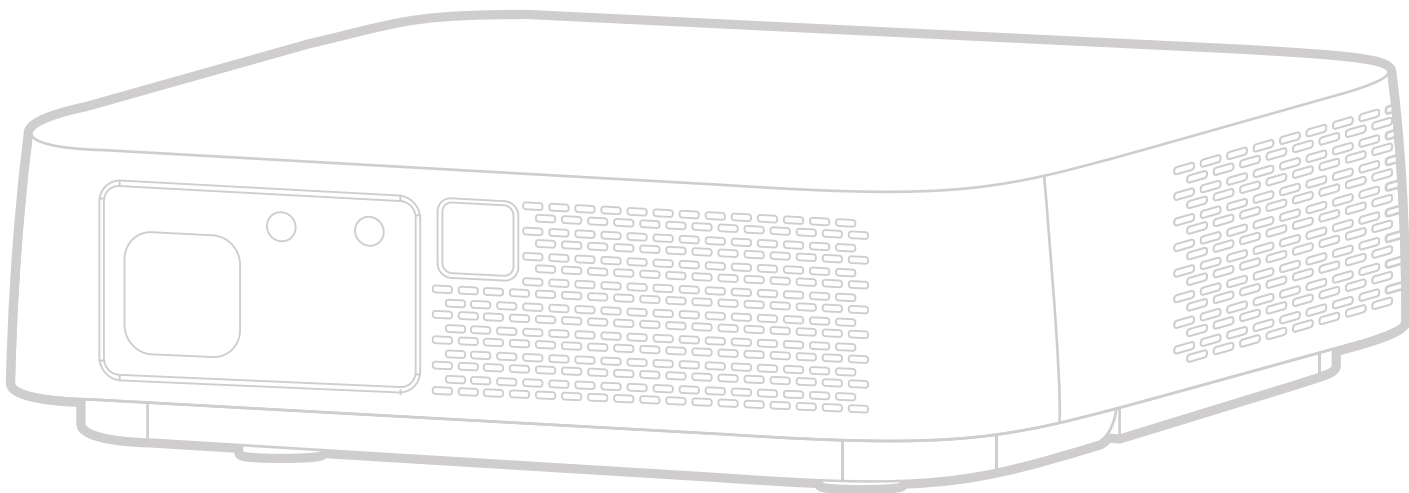

**IMPORTANT:** Please read this User Guide to obtain important information on installing and using your product in a safe manner, as well as registering your product for future service. Warranty information contained in this User Guide will describe your limited coverage from ViewSonic® Corporation, which is also found on our web site at <http://www.viewsonic.com> in English, or in specific languages using the Regional selection box in the upper right corner of our website. "Antes de operar su equipo lea cuidadosamente las instrucciones en este manual"

Model No. VS18294  
P/N: M2e

## **Thank you for choosing ViewSonic®**

As a world-leading provider of visual solutions, ViewSonic® is dedicated to exceeding the world's expectations for technological evolution, innovation, and simplicity. At ViewSonic®, we believe that our products have the potential to make a positive impact in the world, and we are confident that the ViewSonic® product you have chosen will serve you well.

Once again, thank you for choosing ViewSonic®!

## > Safety Precautions

Please read the following **Safety Precautions** before you start using the projector.

- Keep this user guide in a safe place for later reference.
- Read all warnings and follow all instructions.
- Allow at least 20" (50 cm) clearance around the projector to ensure proper ventilation.
- Place the projector in a well-ventilated area. Do not place anything on the projector that prevents heat dissipation.
- Do not place the projector on an uneven or unstable surface. The projector may fall over, causing personal injury or projector malfunction.
- Do not use if the projector is tilted at an angle of more than 10° degrees left or right, nor at an angle of more than 15° degrees forwards or backwards.
- Do not look straight at the projector lens during operation. The intense light beam may damage your eyes.
- Do not block the projection lens with any objects when the projector is under operation as this could cause objects to become heated and deformed or even cause a fire.
- Do not attempt to disassemble the projector. There are dangerous high voltages inside which may cause death if you should come into contact with live parts.
- When moving the projector, be careful not to drop or bump the projector on anything.
- Do not place any heavy objects on the projector or connection cables.
- Do not stand the projector on end vertically. Doing so may cause the projector to fall over, causing personal injury or projector malfunction.
- Avoid exposing the projector to direct sunlight or other sources of sustained heat. Do not install near any heat sources such as radiators, heat registers, stoves, or other devices (including amplifiers) that may increase the temperature of the projector to dangerous levels.
- Do not place liquids near or on the projector. Liquids spilled into the projector may cause it to fail. If the projector does become wet, disconnect it from the power supply and call your local service center to have the projector serviced.
- When the projector is under operation, you may sense some heated air and odor from its ventilation grill. It is a normal operation and not a defect.

- Do not attempt to circumvent the safety provisions of the polarized or grounding-type plug. A polarized plug has two blades with one wider than the other. A grounding-type plug has two blades and a third grounding prong. The wide and third blade are provided for your safety. If the plug does not fit into your outlet, obtain an adapter and do not attempt to force the plug into the outlet.
- When connecting to a power outlet, DO NOT remove the grounding prong. Please ensure grounding prongs are NEVER REMOVED.
- Protect the power cord from being treaded upon or pinched, particularly at the plug, and at the point where it emerges from the projector.
- In some countries, the voltage is NOT stable. This projector is designed to operate safely within a voltage between 100 to 240 volts AC, but could fail if power cuts or surges of  $\pm 10$  volts occur. In areas where voltage may fluctuate or cut out, it is recommended that you connect your projector through a power stabilizer, surge protector, or uninterruptable power supply (UPS).
- If smoke, an abnormal noise, or a strange odor is present, immediately switch the projector off and call your dealer or ViewSonic®. It is dangerous to continue using the projector.
- Use only attachments/accessories specified by the manufacturer.
- Disconnect the power cord from the AC outlet if the projector is not being used for a long period of time.
- Refer all servicing to qualified service personnel.



**CAUTION:** Possibly hazardous optical radiation is emitted from this product. As with any bright light source, do not stare into the beam, RG2 IEC 62471-5:2015



# > Contents

<b>Safety Precautions.....</b>	<b>3</b>
<b>Introduction .....</b>	<b>8</b>
<b>Package Contents .....</b>	<b>8</b>
Product Overview .....	9
Projector.....	9
Connection Ports.....	10
Remote Control .....	11
<b>Initial Setup.....</b>	<b>13</b>
Choosing a Location - Projection Orientation.....	13
Projection Dimensions.....	14
Mounting the Projector .....	15
<b>Making Connections.....</b>	<b>16</b>
Connecting to Power .....	16
DC Power (Power Outlet) .....	16
USB-C Power Bank.....	17
Connecting to External Devices .....	18
HDMI Connection .....	18
USB Connection.....	19
Wireless Screen Mirroring.....	20
Connecting to Audio .....	21
Bluetooth Speaker.....	21
Bluetooth Out.....	23
Connecting to Networks .....	24
Wi-Fi Connection.....	24
Custom SSID .....	26

<b>Using the Projector.....</b>	<b>27</b>
Starting Up the Projector.....	27
First Time Activation.....	27
Auto Focus.....	27
Projection Orientation .....	28
Preferred Language.....	28
Network Settings.....	29
Source Input .....	29
Selecting an Input Source .....	30
Adjusting the Projected Image .....	31
Adjusting the Projector's Height and Projection Angle .....	31
Shutting Down the Projector.....	32
Input Source Selected - On-Screen Display (OSD) Tree.....	33
<b>Operating the Projector.....</b>	<b>45</b>
<b>Home Screen .....</b>	<b>45</b>
Home Screen - On-Screen Display (OSD) Menu Tree .....	46
Menu Operations .....	50
File Management .....	50
Apps Center.....	55
Bluetooth .....	57
Setting .....	58
Screen Mirroring .....	75
<b>Appendix.....</b>	<b>78</b>
Specifications.....	78
Projector Dimensions.....	79
Timing Chart .....	79
HDMI Video Timing .....	79
HDMI PC.....	80
USB C Timing .....	82
Troubleshooting .....	83
LED Indicators.....	84
Maintenance.....	85
General Precautions.....	85
Cleaning the Lens .....	85
Cleaning the Case .....	85
Storing the Projector .....	85

<b>Regulatory and Service Information .....</b>	<b>86</b>
Compliance Information.....	86
FCC Compliance Statement.....	86
Industry Canada Statement.....	86
CE Conformity for European Countries.....	88
Declaration of RoHS2 Compliance.....	89
Indian Restriction of Hazardous Substances .....	90
Product Disposal at End of Product Life .....	90
Copyright Information .....	91
Customer Service .....	92
Limited Warranty .....	93
Mexico Limited Warranty.....	96

# > Introduction

## Package Contents

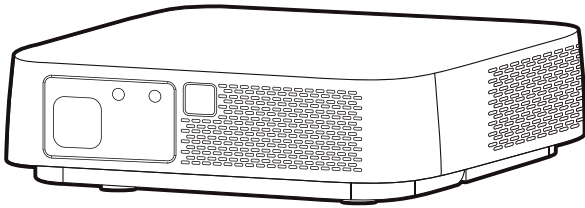

M2e Projector

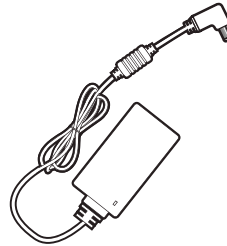

DC Power Adapter

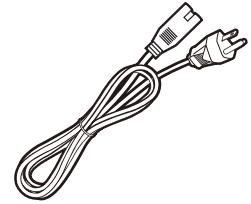

Power Cord

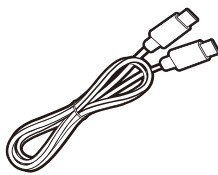

USB Type-C Cable



Batteries



Quick Start Guide

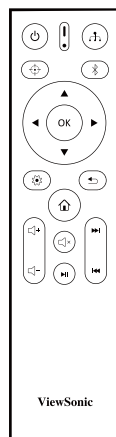

Remote Control



Soft Carrying Bag

**NOTE:** The power cord and video cables included in your package may vary depending on your country. Please contact your local reseller for more information.

# Product Overview

## Projector

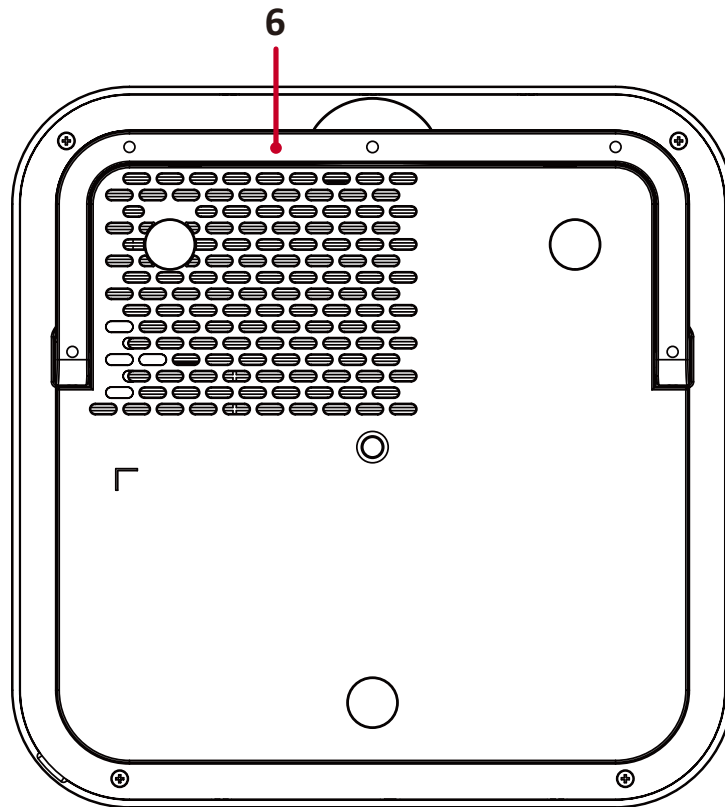
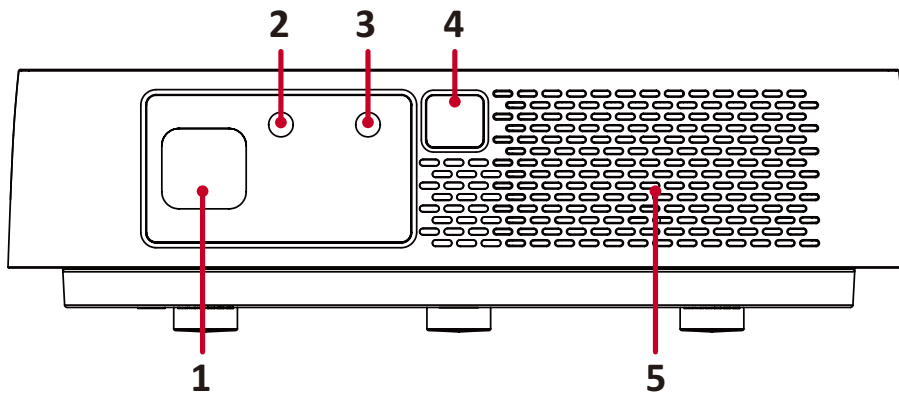

Item	Description
[1] Lens	Projector Lens
[2] IR Sensor	IR Sensor
[3] Auto Focus Camera	Automatically adjusts the focus
[4] Auto Focus Sensor	Automatically adjusts the focus
[5] harmon/kardon Speakers	harmon/kardon speakers
[6] Adjustor Foot	Stepless adjustment foot

## Connection Ports

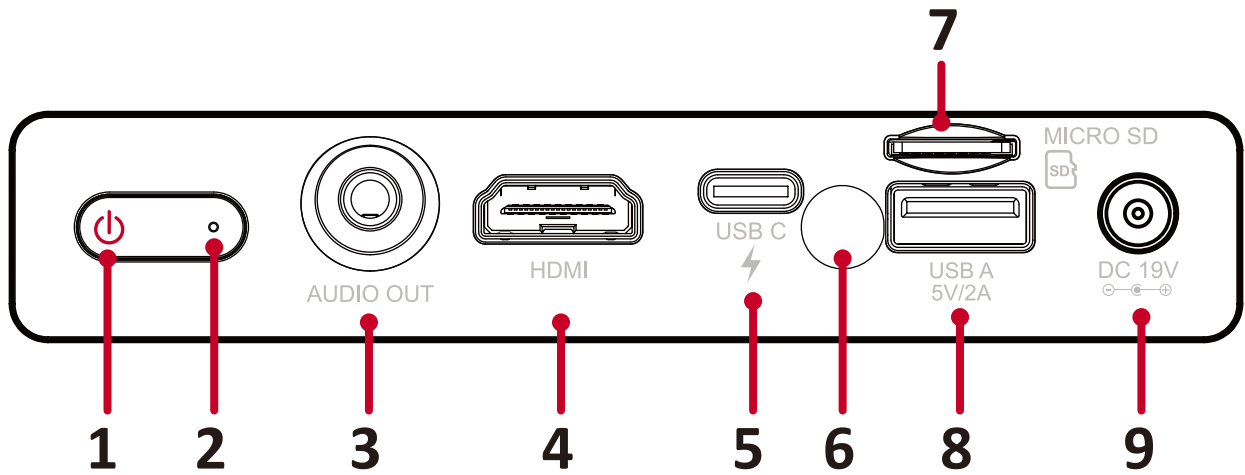











Port	Description
[1] Power Button	Power On/Off
[2] LED Indicator	LED Indicator
[3] Audio Out (3.5 mm jack)	3.5 mm jack audio output socket
[4] HDMI <sup>1</sup>	HDMI port <sup>2</sup>
[5] USB-C <sup>3</sup>	USB-C port
[6] IR Sensor	IR Sensor
[7] MICRO SD	Micro SD socket (SDXC up to 64 GB - FAT32/NTFS)
[8] USB A (5V/2A Out)	USB 2.0 Type A port (USB Reader - FAT32/NTFS)
[9] DC IN	Power input socket

<sup>1</sup> Supports HDCP 1.4/HDMI 1.4

<sup>2</sup> iPhone/iPad users will need to buy an additional adapter. To avoid compatibility issues, please use Apple authorized accessories.

<sup>3</sup> Please use the supplied USB-C cable, and ensure your USB-C device can support video transmission as well as charging.

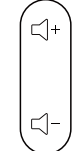
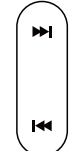
## Remote Control

Button		Description
[1] Power		Turns the projector On or Off
[2] Source		Displays the input source selection bar.
[3] Focus		Automatically focus the image. To manually adjust, press and hold the <b>Focus</b> button on the remote control for three (3) seconds
[4] Bluetooth		Launch Bluetooth search.
[5] OK		Confirms the selection.
[6] Up/Down/Left/Right		Navigates and selects the desired menu items and makes adjustments.
[7] Setting		Displays the <b>Setting</b> menu.
[8] Return		Returns to the previous screen.
[9] Home		Access the <b>Home</b> screen.
[10] Volume		Increase/Decrease the volume level.
[11] Forwards/Backwards		Move content forwards/backwards.
[12] Mute		Mute/Unmute.
[13] Play/Pause		Play/Pause content.

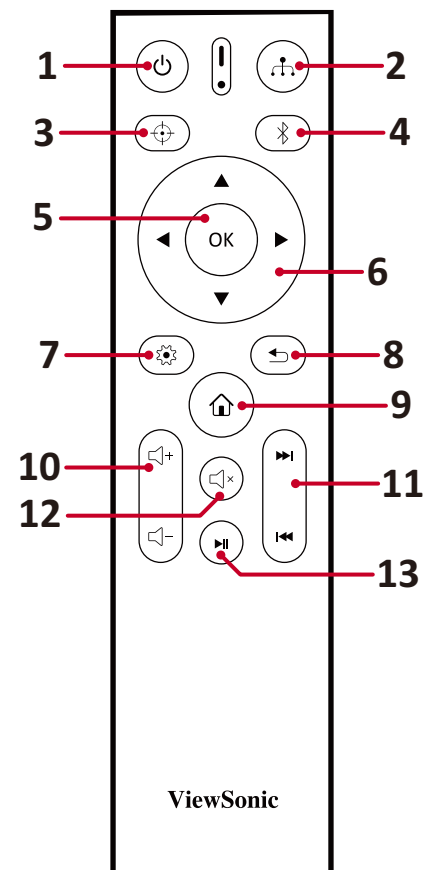

## Remote Control - Effective Range

To ensure proper function of the remote control follow the steps below:

1. The remote control must be held at an angle within 30° perpendicular to the projector's IR remote control sensor(s).
2. The distance between the remote control and the sensor(s) should not exceed 8 m (26 ft.)

**NOTE:** Refer to the illustration for the location of the infrared (IR) remote control sensor(s).

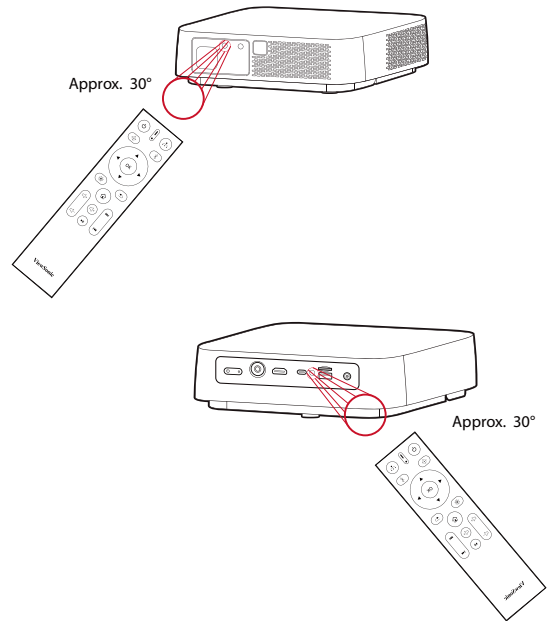

## Remote Control - Replacing the Batteries

3. Remove the battery cover from the bottom of the remote control by pressing the finger grip and sliding it across.
4. Remove any existing batteries (if necessary) and install two AAA batteries.

**NOTE:** Observe the battery's polarities as indicated.

5. Replace the battery cover by aligning it with the base and pushing it back into position.

### **NOTE:**

- Avoid leaving the remote control and batteries in excessive heat or a humid environment.
- Replace only with the same or equivalent type recommended by the battery manufacturer.
- If the batteries are drained or if you will not be using the remote control for an extended period of time, remove the batteries to avoid damage to the remote control.
- Dispose of the used batteries according to the manufacturer's instructions and local environment regulations for your region.



## > Initial Setup

This section provides detailed instructions for the initial set up of your projector.

### Choosing a Location - Projection Orientation

Personal preference and room layout will decide the installation location. Consider the following:

- Size and position of your screen.
- Location of a suitable power outlet.
- Location and distance between the projector and other equipment.

The projector is designed to be installed in one of the following locations:

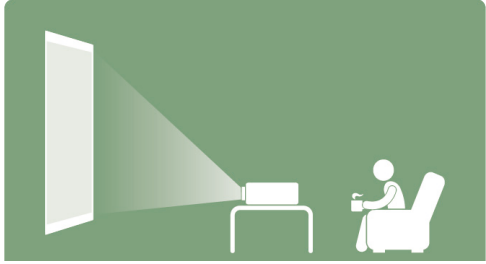
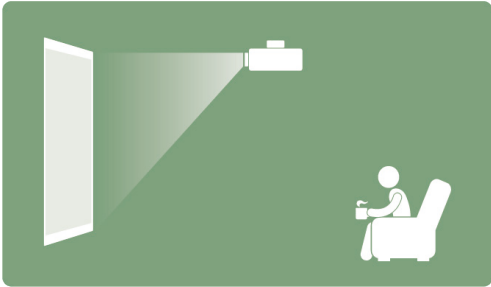
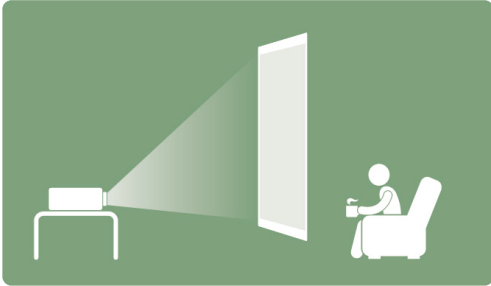
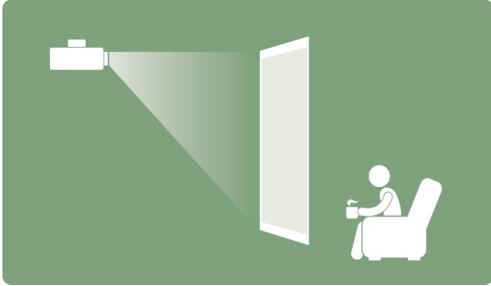
Location	
<p><b>Front Table</b></p> <p>The projector is placed near the floor in front of the screen.</p>	
<p><b>Front Ceiling</b></p> <p>The projector is suspended upside-down from the ceiling in front of the screen.</p>	
<p><b>Rear Table<sup>1</sup></b></p> <p>The projector is placed near the floor behind the screen.</p>	
<p><b>Rear Ceiling<sup>1</sup></b></p> <p>The projector is suspended upside-down from the ceiling behind the screen.</p>	

<sup>1</sup> A rear projection screen is required.

# Projection Dimensions

- 16:9 Image on a 16:9 Screen

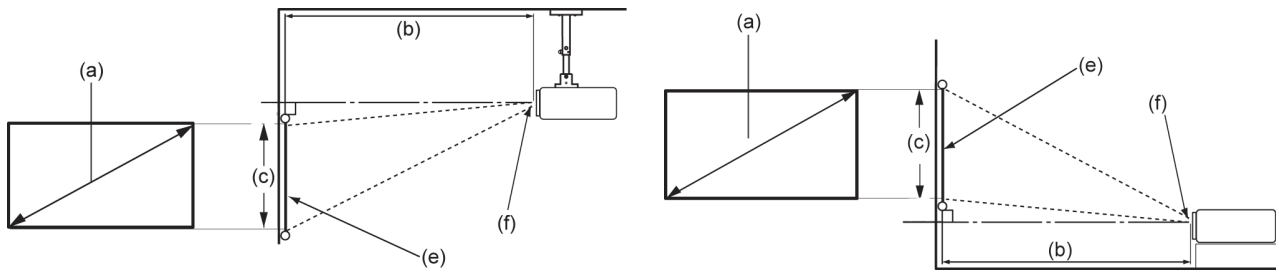

**NOTE:** (e) = Screen / (f) = Center of Lens

## 16:9 Image on a 16:9 Screen

(a) Screen Size		(b) Projection Distance		(c) Image Height		Image Width	
in.	cm	in.	m.	in.	cm	in.	mm
30	76.2	31.64	0.80	14.71	37.36	26.15	664
40	101.6	42.18	1.07	19.61	49.81	34.86	886
50	127	52.73	1.34	24.51	62.26	43.58	1107
60	152.4	63.28	1.61	29.42	74.72	52.29	1328
70	177.8	73.82	1.88	34.32	87.17	61.01	1550
80	203.2	84.37	2.14	39.22	99.62	69.73	1771
90	228.6	94.91	2.41	44.12	112.07	78.44	1992
100	254	105.46	2.68	49.03	124.53	87.16	2214

**NOTE:** There is a 3% tolerance among these numbers due to optical component variations. It is recommended to physically test the projection size and distance before permanently installing the projector.

## Mounting the Projector

**NOTE:** If you buy a third party mount, please use the correct screw size. Screw size can vary depending on the thickness of the mounting plate.

1. To ensure the most secure installation, please use a ViewSonic® wall or ceiling mount.
2. Ensure the screws used to attach the mount to the projector meet the following specifications:
  - Screw type: M4 x 8
  - Maximum Screw Length: 8 mm
3. To access the ceiling mount points, remove the three (3) foot pads on the bottom of the projector.

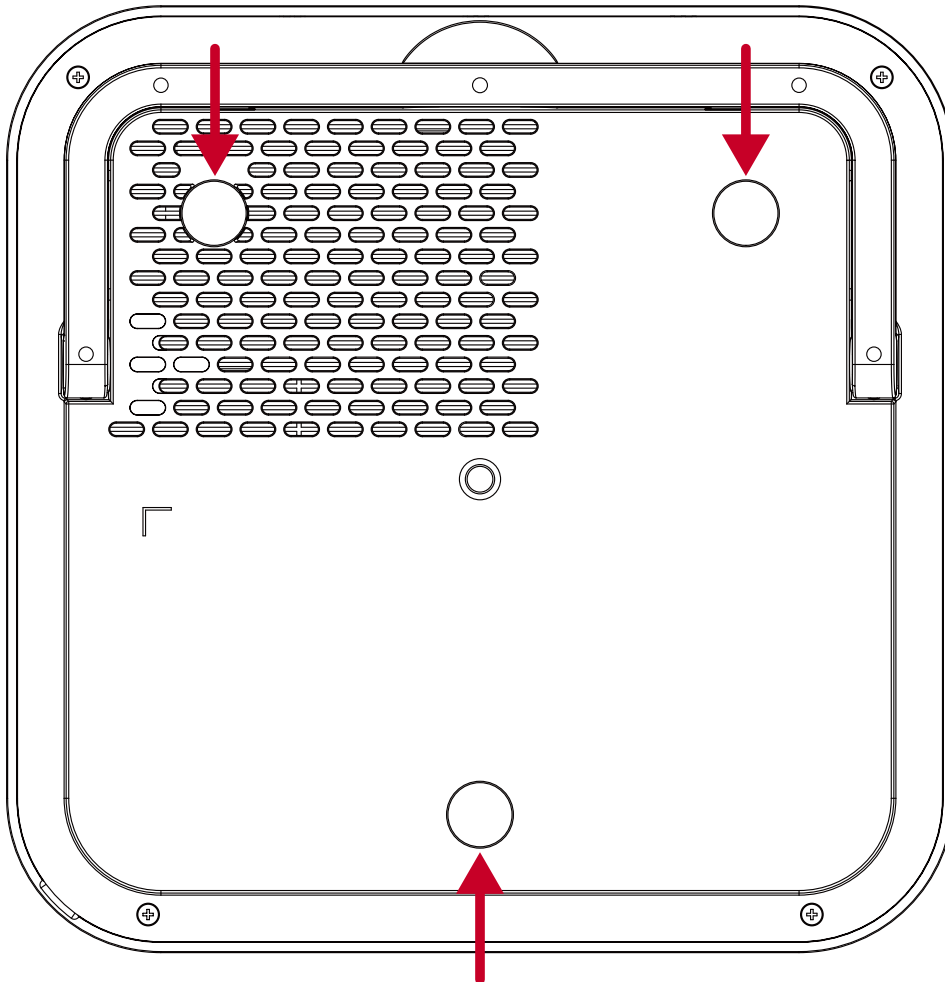

### CAUTION:

- Avoid installing the projector near a heat source.
- Keep at least a 10 cm (3.9 in.) gap between the ceiling and the bottom of the projector.

## > Making Connections

This section guides you on how to connect the projector with other equipment.

### Connecting to Power

#### DC Power (Power Outlet)

1. Connect the power cord to the power adapter.
2. Connect the power adapter to the DC IN jack at the rear of the projector.
3. Connect the power cord plug to a power outlet. When connected, the projector will turn on automatically.

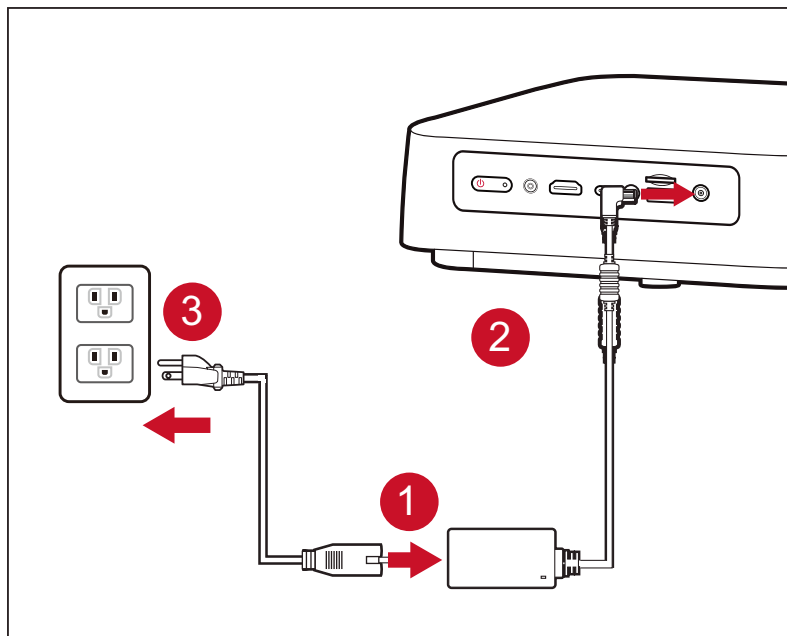

**NOTE:** When installing the projector, incorporate a readily accessible disconnect device in the fixed wiring, or connect the power plug to an easily accessible outlet near the unit. If a fault should occur during operation of the projector, use the disconnect device to switch off the power supply, or disconnect the power plug.

## USB-C Power Bank

1. Connect one end of the USB Type-C cable to the **USB-C** port of the projector.
2. Connect the other end of the USB Type-C cable to the power bank.

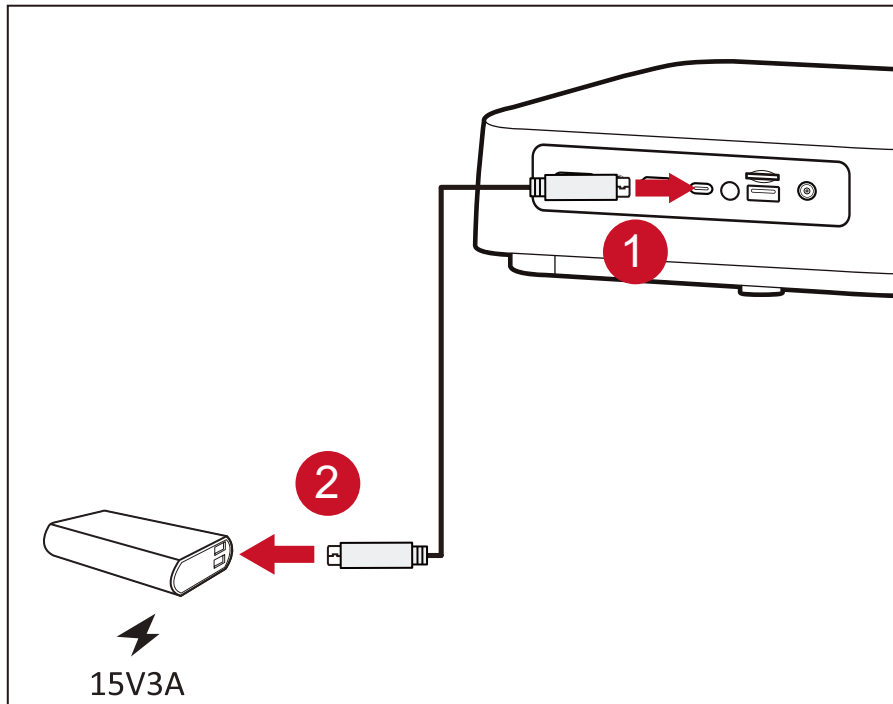

**NOTE:** The power bank should be 45W (15V/3A) at least, and support Power Delivery (PD) protocol output.

# Connecting to External Devices

## HDMI Connection

Connect one end of an HDMI cable to the HDMI port of your video device. Then connect the other end of the cable to the **HDMI** port (it supports HDCP 1.4/HDMI 1.4) of your projector.

**NOTE:** iPhone/iPad users will need to use an additional adapter.

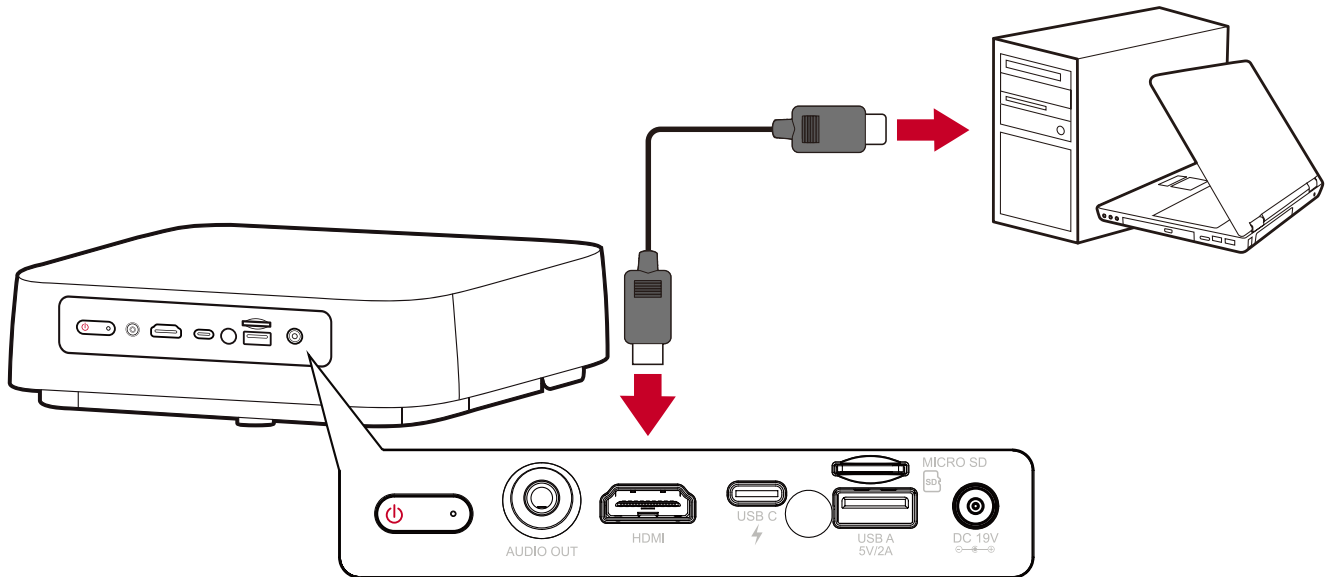

## USB Connection

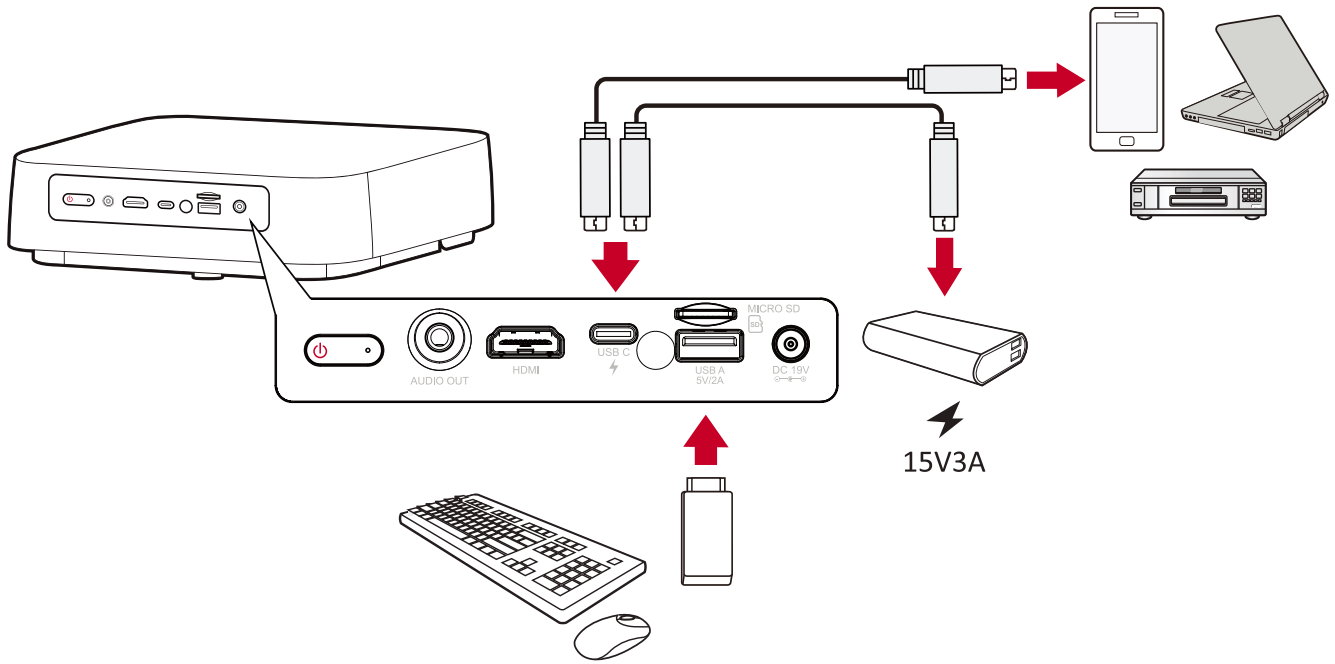

## USB-C Connection

Connect one end of a USB Type-C cable to the USB-C port of your device. Then connect the other end of the cable to the **USB-C** port of your projector.

### NOTE:

- Ensure your USB Type-C device can support video transmission.
- The M2e can also use a USB-C connected power bank to turn on the system. However, the brightness level will be limited to 50% and 30% when the **Light Source Level** is set as **Full** or **Eco** respectively.

## USB Type-A Connection

Connect one end of a USB Type-A cable to the USB-A port of your device (if applicable). Then connect the other end of the cable to the **USB A** port of your projector.

Additionally, you can connect a keyboard, a mouse, dongles, storage devices, etc. to the projector's **USB-A** port. To learn more about managing storage device, e.g. USB Flash Drive, content, see page 50.

## Wireless Screen Mirroring

Screen Mirroring provides a 5GHz Wi-Fi connection for users to mirror the screen on their personal device.

**NOTE:** Ensure your device is connected to the same network as the projector.

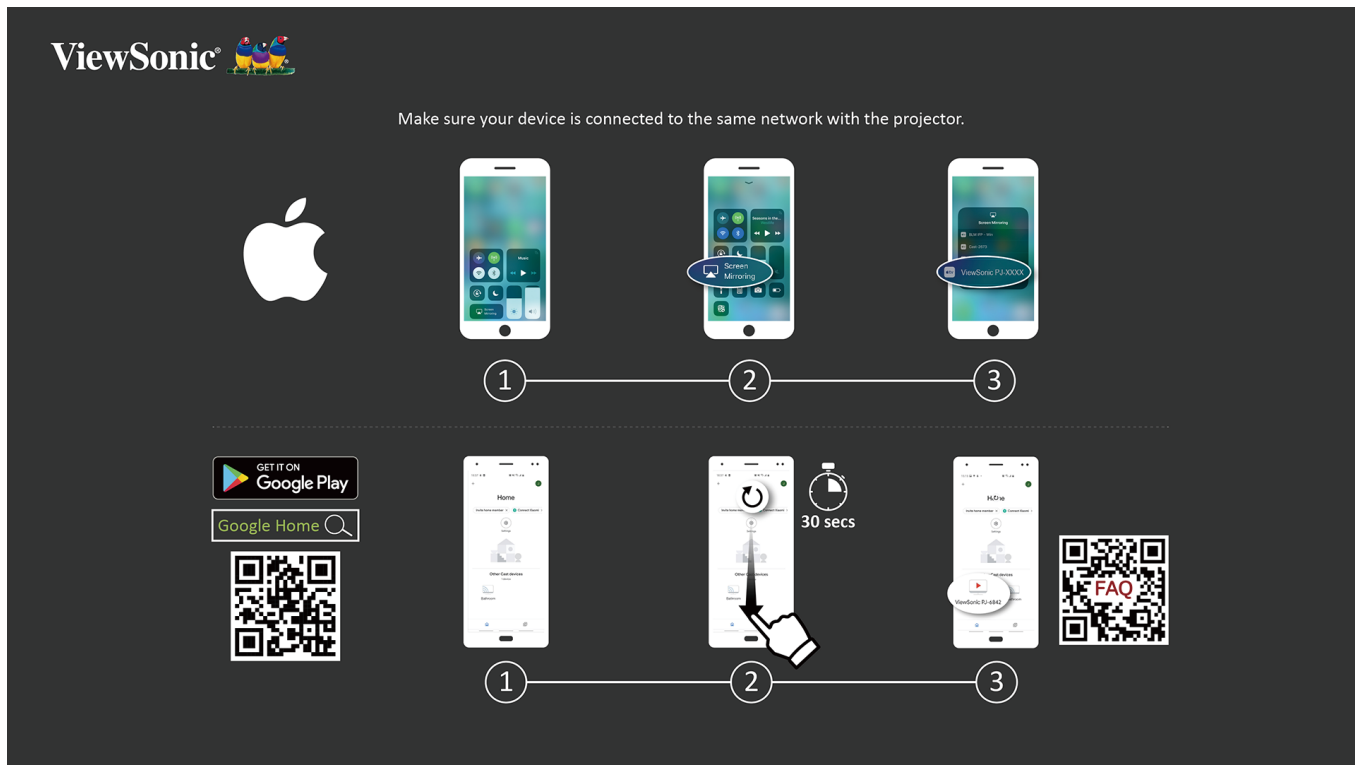

### For iOS:

1. Access the drop down control menu.
2. Select the “Screen Mirroring” icon.
3. Choose “ViewSonic PJ-XXXX”.

### For Android:

1. Download and install the “Google Home” application and open it.
2. Pull-to-refresh the app and wait for 30 seconds.
3. “ViewSonic PJ-XXXX” will now be visible, select it.

**NOTE:** Some Android devices support direct “Casting”. If your device does, go to the Casting feature and choose “ViewSonic PJ-XXX” from the list of available devices. You can also scan the FAQ QR code and follow the steps to directly cast your Android device.



# Connecting to Audio

## Bluetooth Speaker

The projector is equipped with Bluetooth that allows the user to connect their device wirelessly for audio playback.

To connect and pair your device:

1. Go to: **Home > Bluetooth.**
2. Use the **Left** and **Right** directional buttons on the remote control to select **Bluetooth Speaker** or **Bluetooth Pairing**. Then press **OK** on the remote control.

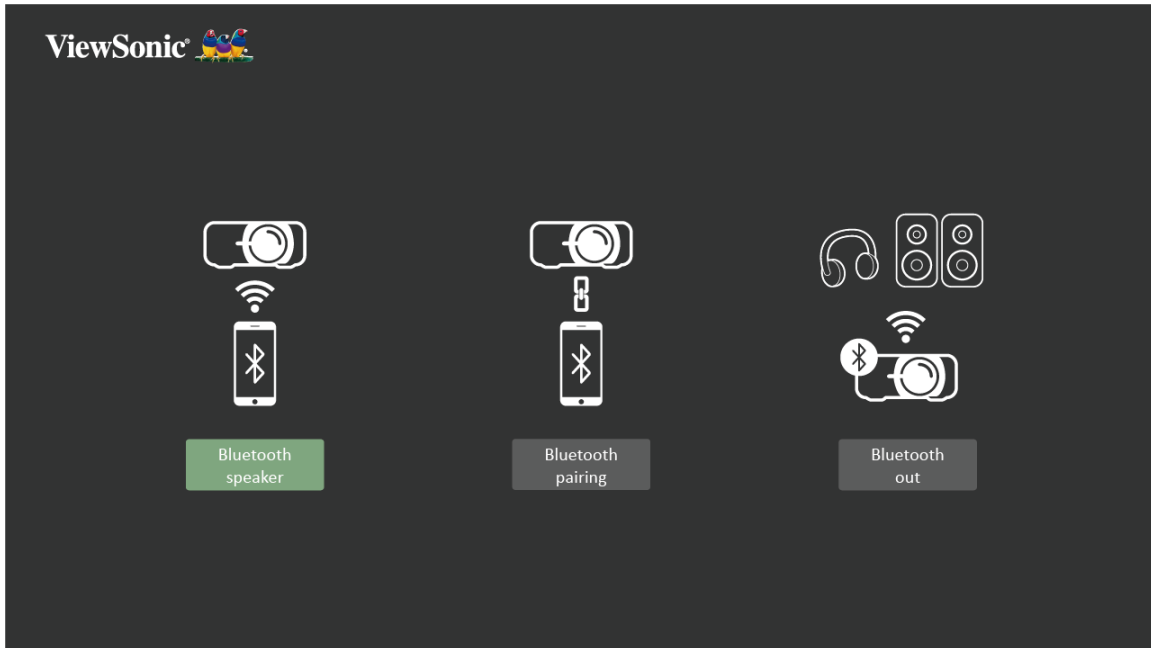

3. When the below dialogue box appears, select **Yes** and press **OK** on the remote control to enter Bluetooth mode.

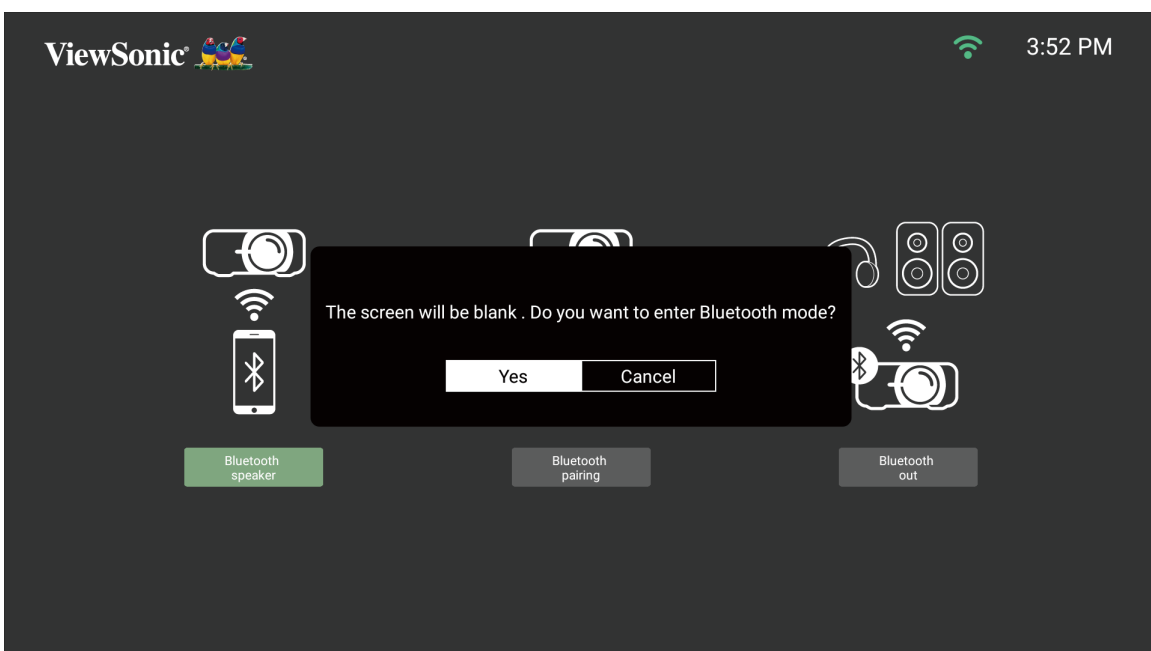

4. A sound effect will be audible upon entering pairing mode.
5. Upon successful connection, another sound effect will be audible.

**NOTE:**

- Once paired, if both the projector and your device are powered on they will automatically connect via Bluetooth.
- The projector's name will be labeled as "M2e".
- Only the Power and Return buttons can exit Bluetooth mode.

## Bluetooth Out

Connect the projector to external headphones or speakers that support Bluetooth.

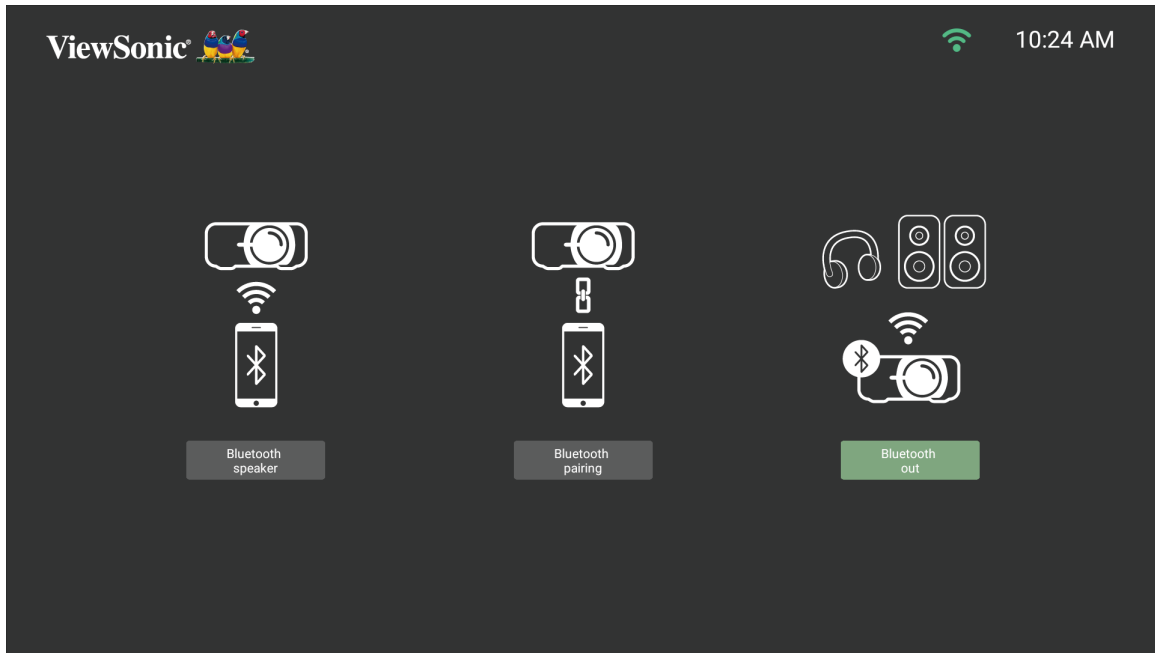

To connect and pair your device:

1. Go to: **Home > Bluetooth.**
2. Use the **Left** and **Right** directional buttons on the remote control to select the **Bluetooth Out** option.



3. The projector will search for nearby Bluetooth devices. Select your device from the list and press **OK** on the remote control.

# Connecting to Networks

## Wi-Fi Connection

To connect to a Wi-Fi network:

1. Go to: **Home > Setting > Network Settings > Wi-Fi**
2. Press **Left** or **Right** on the remote control to select **Enable**.



3. Available Wi-Fi networks will then be displayed. Select one of the available Wi-Fi networks.



4. If you connect to a secure Wi-Fi network, you must enter the password when prompted.

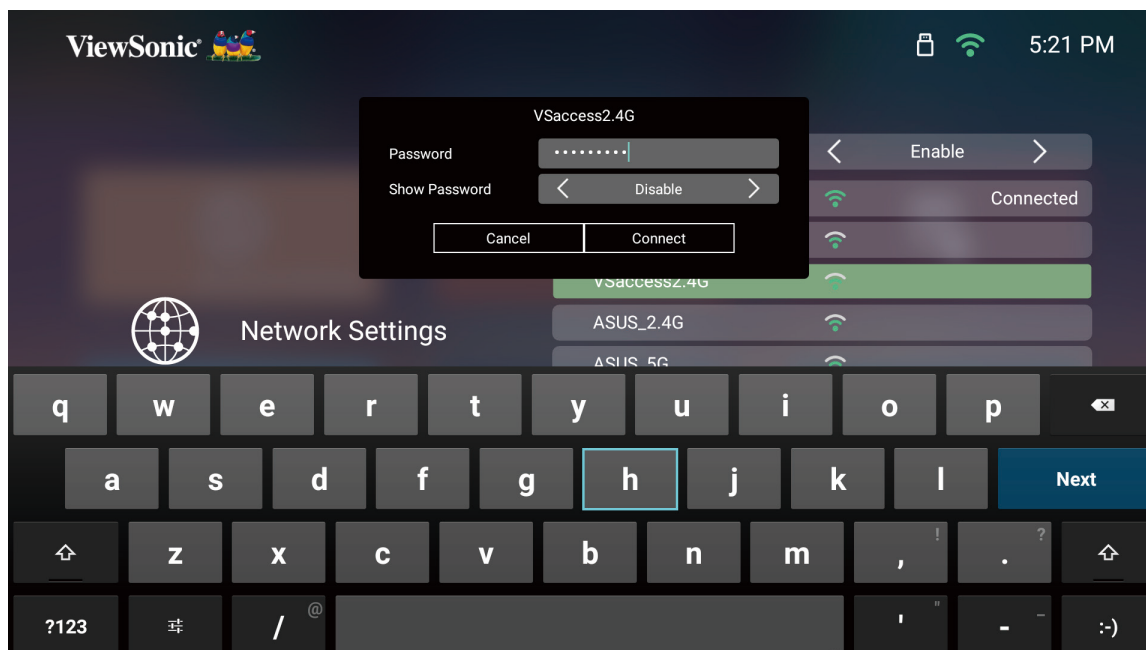

## Custom SSID

1. Go to: **Home > Setting > Network Settings > Wi-Fi**
2. Press **Left** or **Right** on the remote control to select **Enable**.
3. From the available Wi-Fi networks list select **Others** and press **OK** on the remote control.

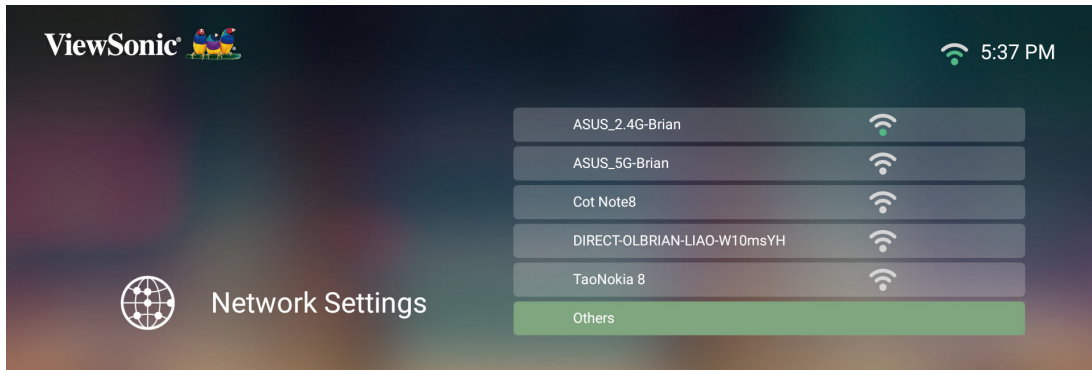

4. Enter the SSID and select the security level.



5. Enter the password when prompted.

**NOTE:** It is recommended to let the system configure the network settings automatically by choosing **Automatic** for **Configure IP**.

# > Using the Projector

## Starting Up the Projector

1. Ensure the projector's power cord is properly connected to a power outlet.
2. After plugging in the DC Power Adapter, the projector will turn on automatically.

**NOTE:** The Status LED will be green during startup.

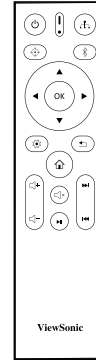
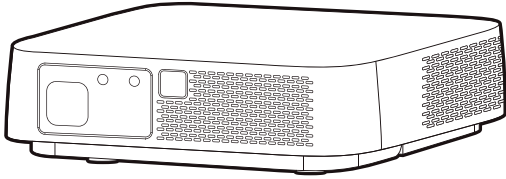

## First Time Activation

If the projector is activated for the first time, you will need to select your Projection Orientation, Preferred Language, Network Settings, and Source Input. Follow the on-screen instructions using the **OK** and **Up/Down/Left/Right** buttons on the remote control. When the Finish screen appears, this indicates the projector is ready to use.

## Auto Focus

The automatic focus adjustment will run for the first time activation.





## Projection Orientation

Select the preferred projection orientation and press **OK** to confirm the selection.  
For more information, see page 13.

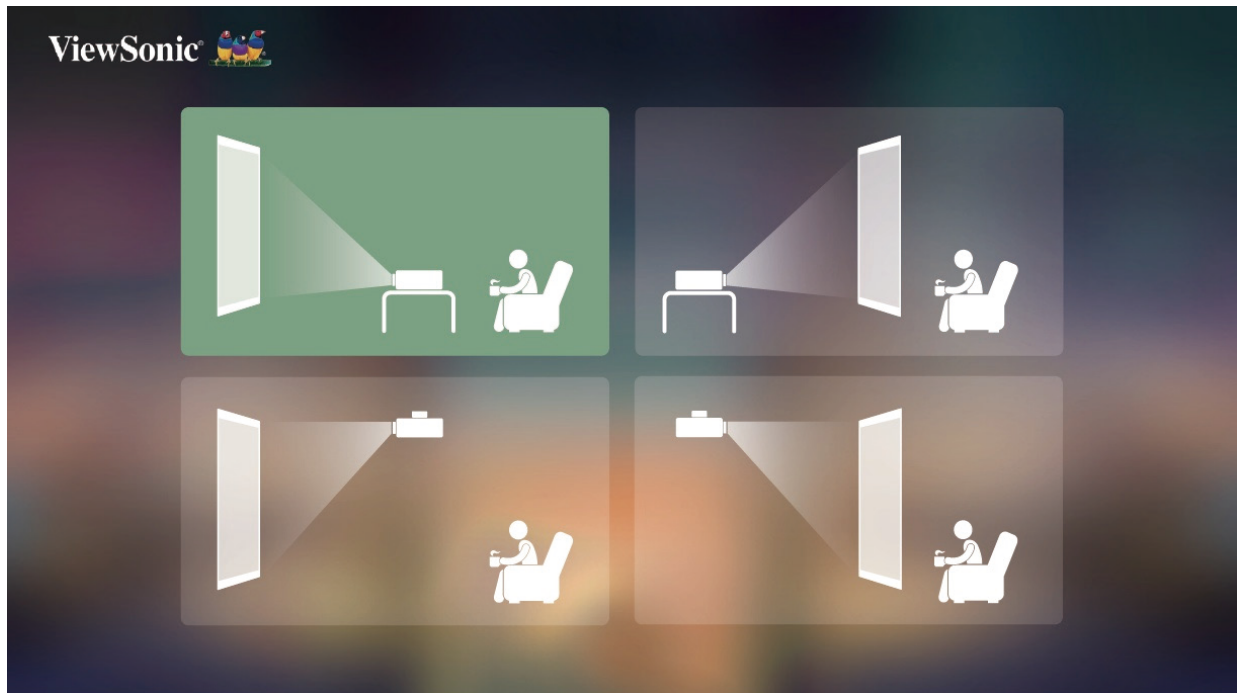

## Preferred Language

Select the desired language and press **OK** to confirm the selection.





## Network Settings

Select one of the available options. For more information, see page 24.



## Source Input

Quickly access the **Source Input** menu by pressing the **Down** button on the remote control when at the **Home Screen**. Additionally, you can press the **Source** button on the remote control. For more information, see page 30.



## Selecting an Input Source

The projector can be connected to multiple devices at the same time. However, it can only display one full screen at a time.

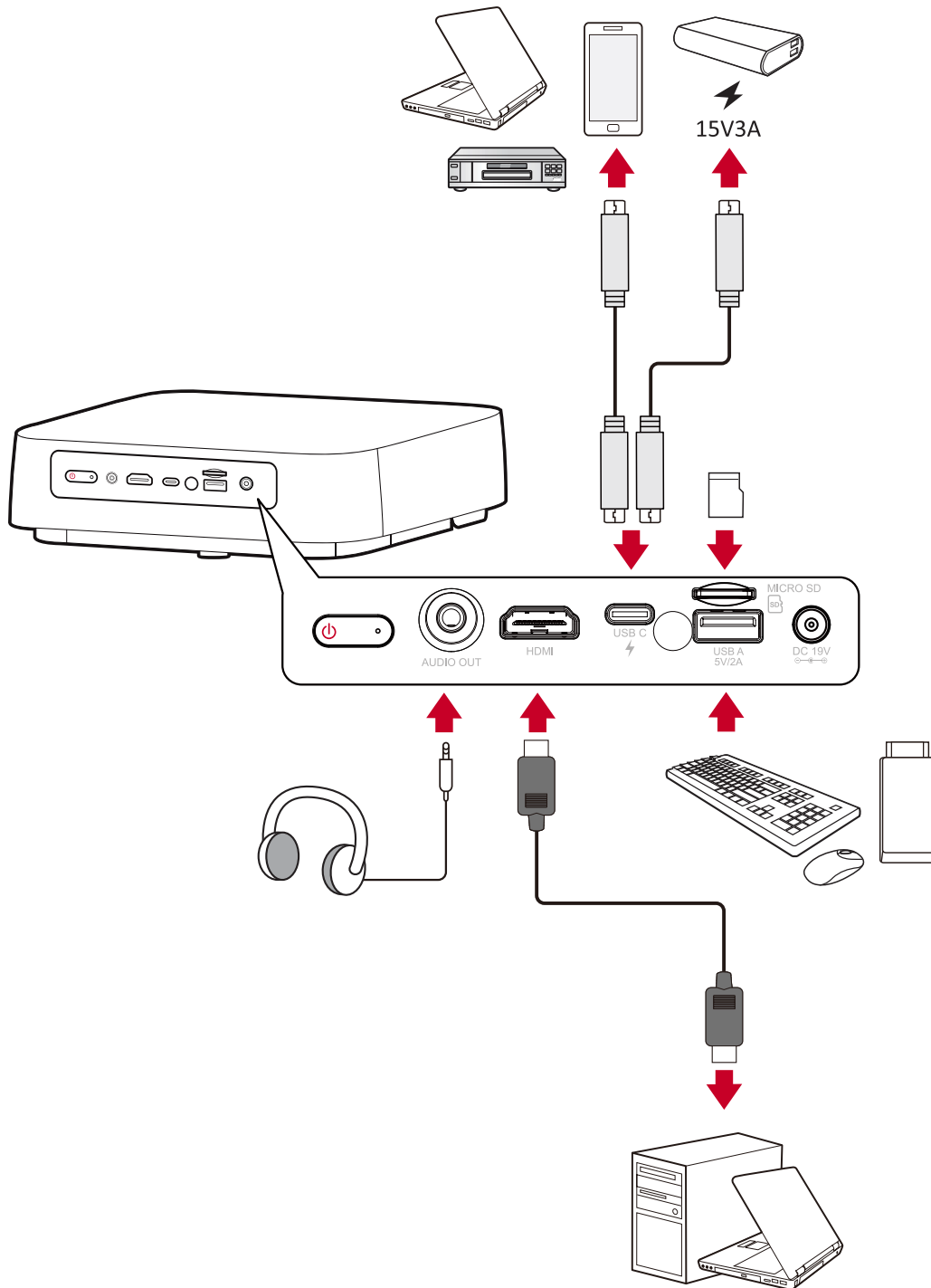

The projector will automatically search for input sources. If multiple sources are connected, press the **Source** button on the remote control to select the desired input, or press the **Down** button when at the **Home Screen** until the source list is displayed.

**NOTE:** Ensure the connected sources are also turned on.

## Adjusting the Projected Image

### Adjusting the Projector's Height and Projection Angle

The projector is equipped with one (1) adjuster foot. Adjusting the foot will change the projector's height and the vertical projection angle. Carefully adjust the foot to fine tune the projected image's position.

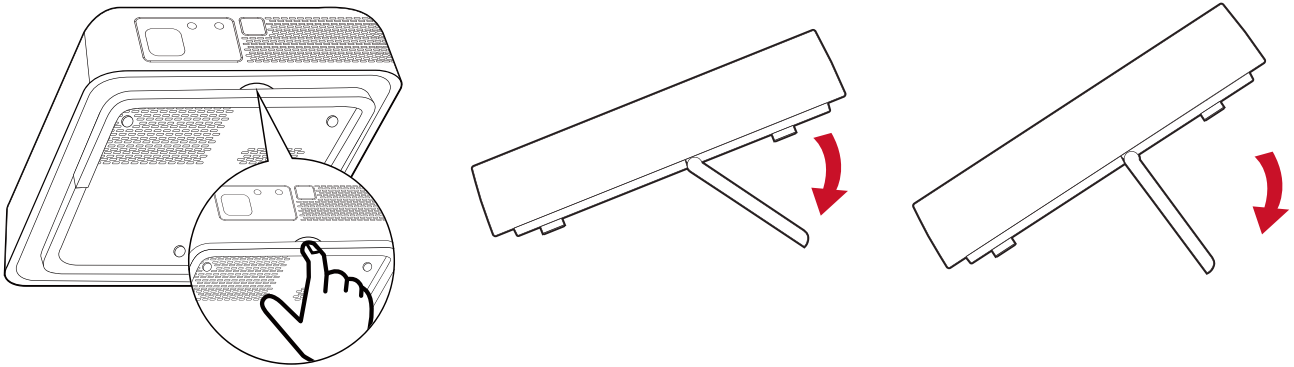

**NOTE:** If the projector is not placed on a flat surface or the screen and the projector are not perpendicular to each other, the projected image can become trapezoidal. However, the “Auto Keystone” function will correct the issue automatically.

# Shutting Down the Projector

1. Press the **Power** button on the projector or remote control and the following message will appear:

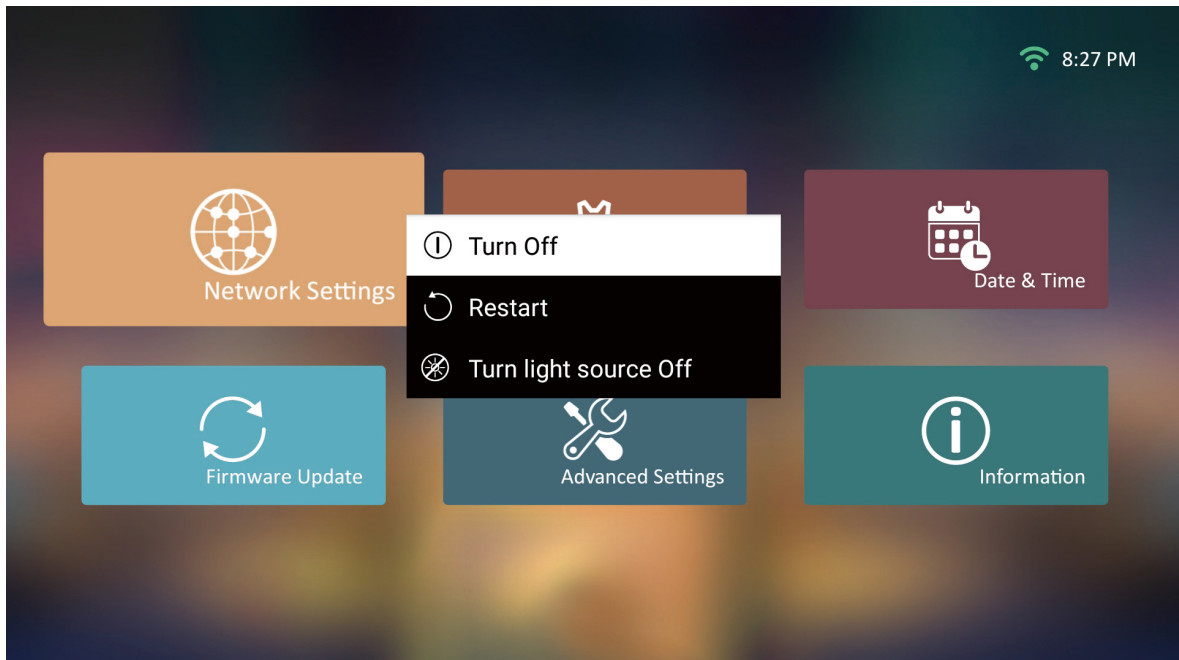

2. Press the **Up/Down** buttons on the remote control to select **Turn Off** and press **OK** on the remote control.
3. The Status LED will turn solid red once turned off.

**NOTE:** When pressing **Power** on the remote control, you can choose from three options: Turn Off, Restart, and Turn light source Off.

## Input Source Selected - On-Screen Display (OSD) Tree

After your input source is selected, you can adjust the **Image Setting** and **Advanced** menus.

Main Menu	Sub-menu	Menu Option		
Image Setting	Color Mode	Brightest		
		TV		
		Movie		
		Gaming		
		User 1		
		User 2		
	Brightness	(-/+ , 0~100)		
	Contrast	(-/+ , 0~100)		
	Color Temp	6500K		
		7500K		
		9300K		
		User	Red Gain	(-/+ , 0~199)
			Green Gain	(-/+ , 0~199)
			Blue Gain	(-/+ , 0~199)
	Red Offset		(-/+ , 0~100)	
	Green Offset	(-/+ , 0~100)		
	Blue Offset	(-/+ , 0~100)		
	Tint	(-/+ , 0~100)		
	Saturation	(-/+ , 0~100)		
	Sharpness	(-/+ , 0~60)		
	Gamma	1.8		
2.0				
2.2				
2.35				
2.5				
sRGB				
Cubic				

Main Menu	Sub-menu	Menu Option				
Image Setting	Color Management	Primary Color	Red			
			Green			
			Blue			
			Cyan			
			Magenta			
			Yellow			
		Hue	(-/+ , 0~100)			
		Saturation	(-/+ , 0~30)			
	Gain	(-/+ , 0~60)				
	Reset Current Color Settings	Reset				
Cancel						
Advanced	Aspect Ratio	Auto				
		4:3				
		16:9				
		16:10				
	Zoom	OK			0.8x~1.0x	
	Light Source Level	Full				
		Eco				
	HDMI Setting	Range			Auto	
			Full Range			
			Limited			

Main Menu	Sub-menu	Menu Option	
Advanced	3D Settings	3D Sync	Auto
			Disable
			Frame Sequential
			Frame Packing
			Top-Bottom
			Side-by-Side
		3D Sync Invert	Disable
			Invert
	harman/kardon	Audio Mode	Movie
			Music
			User
		100Hz	
		500Hz	
		1500Hz	
		5000Hz	
		10000Hz	
		Audio Volume	(0~50)
		Mute	Disable
			Enable
	Information	Source	
		Resolution	
3D Format			

## Image Setting Menu

After your input source is selected, you can adjust the **Image Setting** menu.

To access the **Image Setting** menu:

1. Press **Setting** on the remote control.

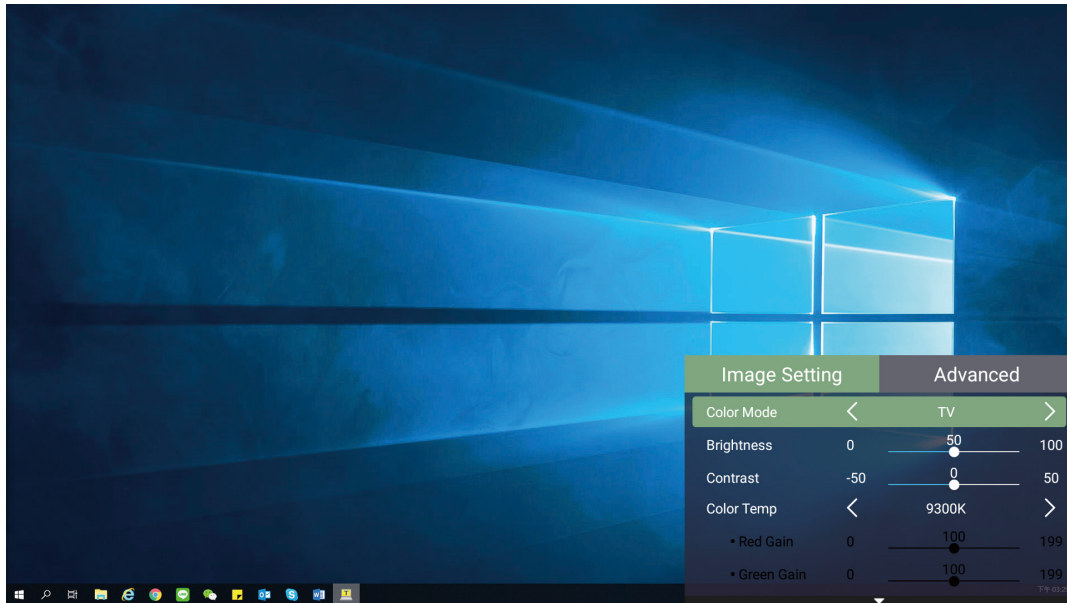

2. Use the **Up/Down** buttons to select a menu.

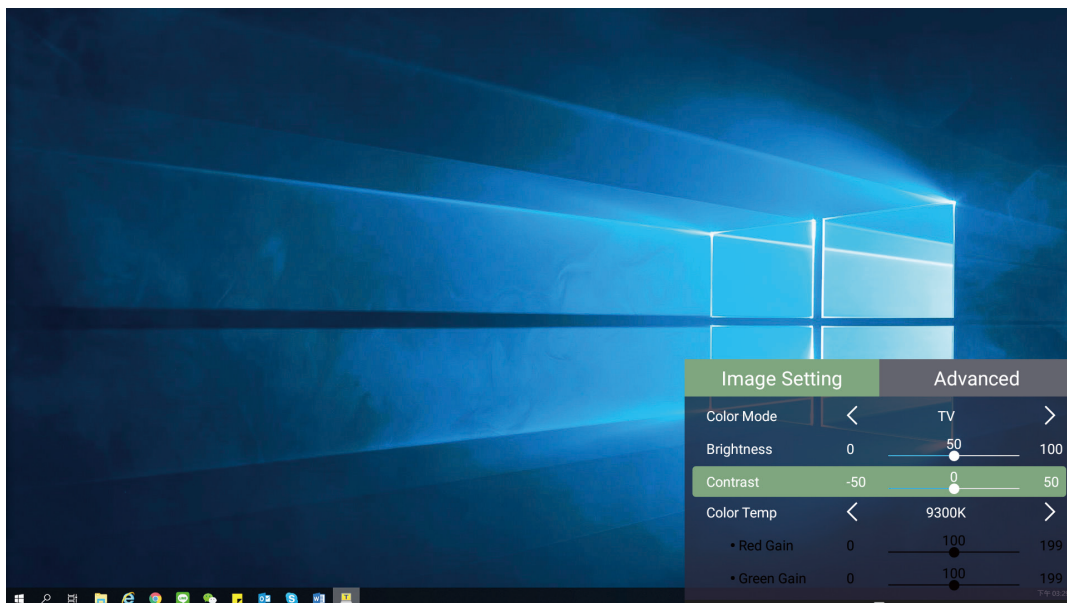



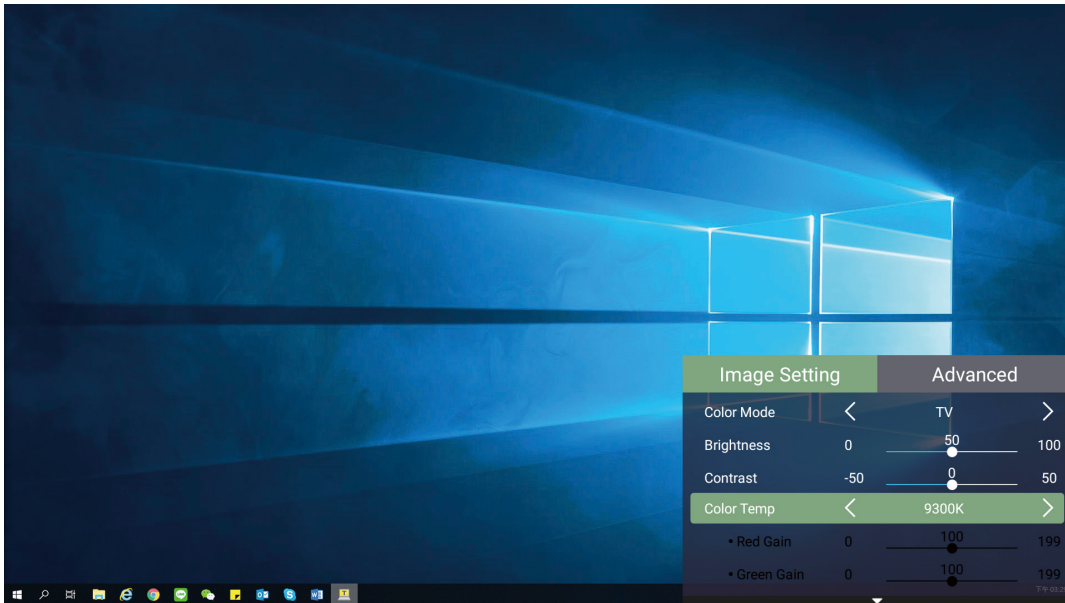



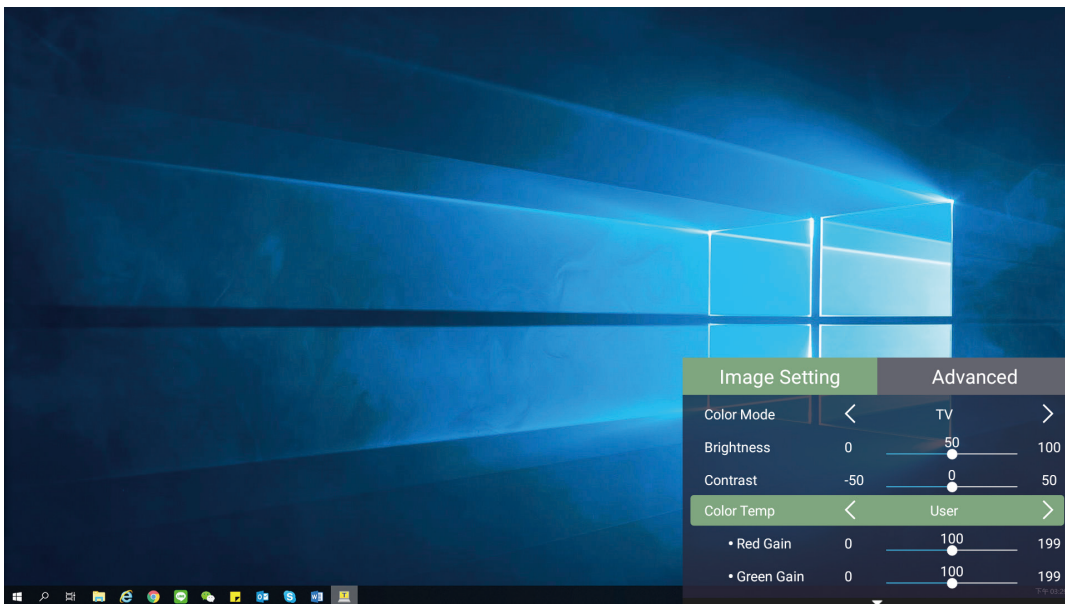



3. Then use the **Left/Right** buttons to enter the sub-menu(s) and/or adjust the settings.



4. Press the **Return** button to go to the previous menu or exit.

Menu Option	Description
Color Mode	<p>The projector is preset with several predefined picture modes so that you can choose one to suit your operating environment and input signal.</p> <p><b><u>Brightest</u></b> Maximizes the brightness of the projected image. This mode is suitable for environments where extra-high brightness is required, i.e. well-lit rooms.</p> <p><b><u>TV</u></b> Optimized for viewing sports in well-lit environments.</p> <p><b><u>Gaming</u></b> Designed for playing video games.</p> <p><b><u>Movie</u></b> Appropriate for colorful movies, video clips from digital cameras, or DVs through the PC input. Best for low-light environments.</p> <p><b><u>User 1/User 2</u></b> Recalls the customized user settings.</p> <p><b>NOTE:</b> Only supports HDMI/USB-C signal input.</p>
Brightness	<p>The higher the value, the brighter the image. Lower values will result in a darker image.</p> <div style="display: flex; justify-content: space-around; align-items: flex-end;"> <div style="text-align: center;">  <p>30</p> </div> <div style="text-align: center;">  <p>50</p> </div> <div style="text-align: center;">  <p>80</p> </div> </div>
Contrast	<p>Use this to set the peak white level after you have previously adjusted the <b>Brightness</b> setting to suit your selected input and viewing environment.</p> <div style="display: flex; justify-content: space-around; align-items: flex-end;"> <div style="text-align: center;">  <p>30</p> </div> <div style="text-align: center;">  <p>50</p> </div> <div style="text-align: center;">  <p>80</p> </div> </div>

Menu Option	Description
Color Temp	Select the color temperature setting. <ul style="list-style-type: none"> <li>• 6500K: Maintains normal white coloring.</li> <li>• 7500K: A higher, cooler color temperature than 6500K.</li> <li>• 9300K: The highest color temperature; makes the image appear the most bluish-white.</li> <li>• User Color: Adjust red, green, and blue values as desired.</li> </ul>
Tint	The higher the value, the more greenish the picture becomes. The lower the value, the more reddish the picture becomes.
Saturation	Refers to the amount of that color in a video picture. Lower settings produce less saturated colors; in fact, a setting of "0" removes that color from the image entirely. If the saturation is too high, that color will be overpowering and unrealistic.
Sharpness	A high value results in a sharper picture; a low value softens the picture.
Gamma	Reflects the relationship between input source and picture brightness.

Menu Option	Description
<p>Color Management</p>	<p>Only in permanent installations with controlled lighting levels such as: boardrooms, lecture halls, or home theaters should <b>Color Management</b> be considered.</p> <div data-bbox="676 331 1246 869" data-label="Diagram"> </div> <p><b>Color Management</b> provides fine color control adjustment to allow for more accurate color reproduction, should you require it.</p> <p>If you have purchased a test disc, which contains various color test patterns and can be used to test the color presentation on monitors, TVs, projectors, etc., you can project any image from the disc on the screen and enter the <b>Color Management</b> menu to make adjustments.</p>
<p>Reset Current Color Settings</p>	<p>Return current color settings to their default values.</p>

## Advanced Setting Menu

After your input source is selected, you can adjust the **Advanced** menu.

To access the **Advanced** menu:

1. Press **Setting** on the remote control.

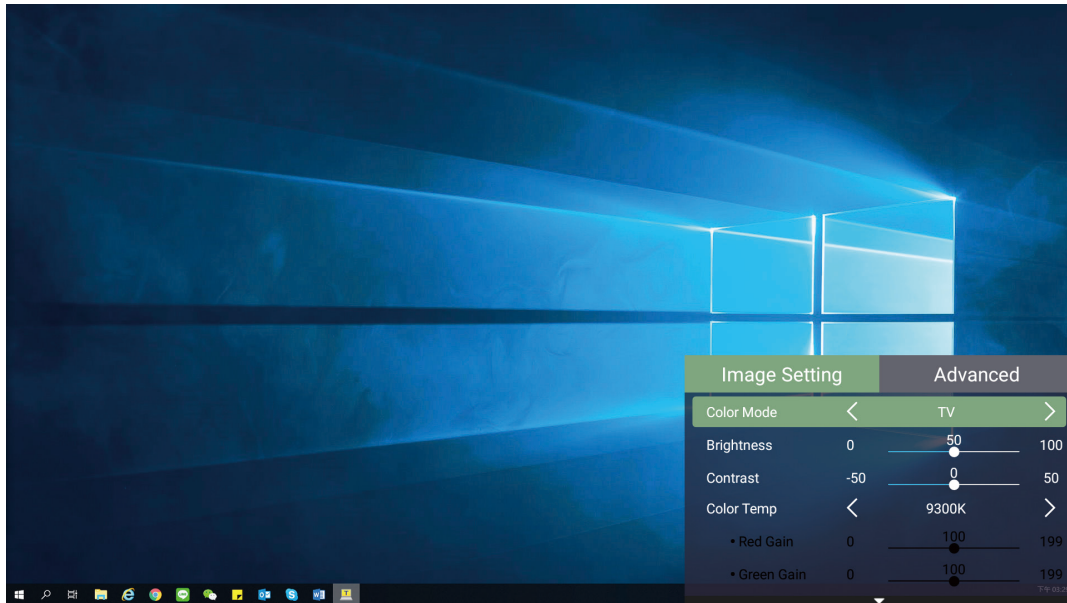

2. Press the **Right** button to access the **Advanced** menu.

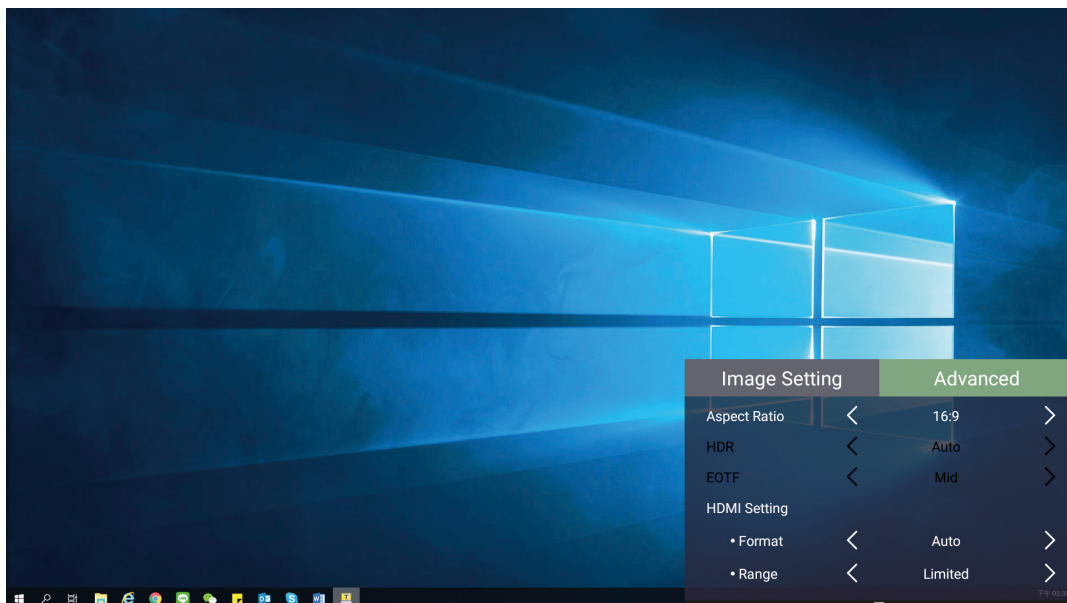

3. Use the **Up/Down** buttons to select a menu.

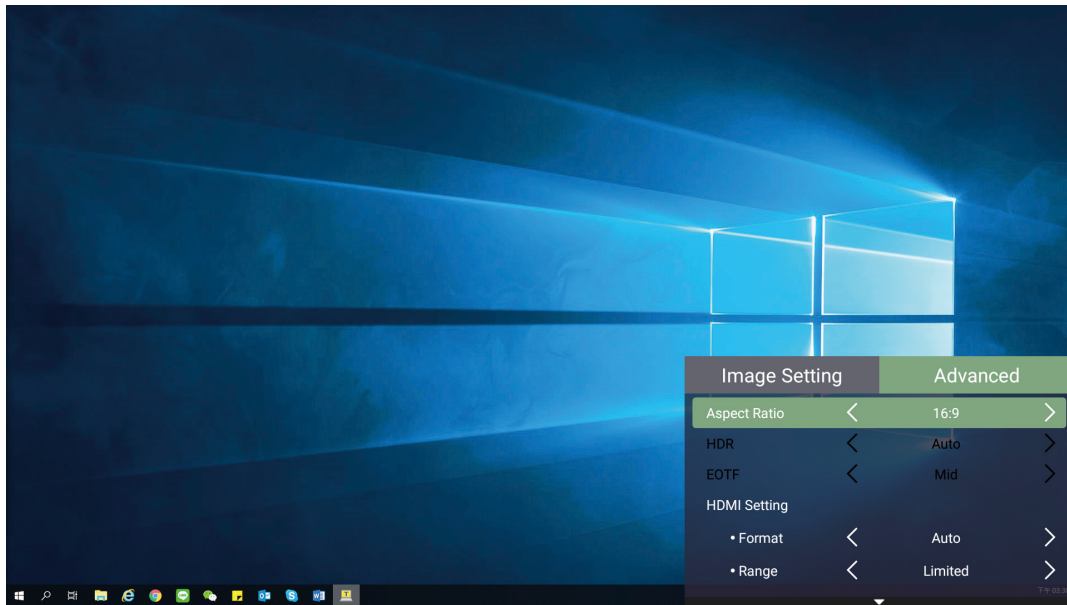

4. Then use the **Left/Right** buttons to enter the sub-menu(s) and/or adjust the settings.

5. Press the **Return** button to go to the previous menu or exit.



Menu Option	Description
Aspect Ratio	<p>The <b>Aspect Ratio</b> is the ratio of the image width to the image height. With the advent of digital signal processing, digital display devices, like this projector, can dynamically stretch and scale the image output to a different aspect than that of the image input signal.</p> <p><b>NOTE:</b> Only supports HDMI/USB-C signal input.</p> <p><b><u>Auto</u></b> Scales an image proportionally to fit the projector's native resolution in its horizontal width. This is suitable for the incoming image which is neither 4:3 nor 16:9 and you want to make the most use of the screen without altering the image's aspect ratio.</p> <p><b><u>4:3</u></b> Scales an image so that it is displayed in the center of the screen with a 4:3 aspect ratio. This is most suitable for 4:3 images like computer monitors, standard definition TV, and 4:3 aspect DVD movies, as it displays them without aspect alteration.</p> <p><b><u>16:9</u></b> Scales an image so that it is displayed in the center of the screen with a 16:9 aspect ratio. This is most suitable for images which are already in a 16:9 aspect, like high definition TV.</p> <p><b><u>16:10</u></b> Scales an image so that it is displayed in the center of the screen with a 16:10 aspect ratio. This is most suitable for images which are already in a 16:10 aspect.</p>
Zoom	Activate the zoom function.
Light Source Level	Select the suitable power consumption of the LED.

Menu Option	Description
HDMI Settings	<p><b><u>Range</u></b></p> <p>Select a suitable color range according to the color range setting of the connected output device.</p> <ul style="list-style-type: none"> <li>• Full: Sets the color range from 0~255.</li> <li>• Limited: Sets the color range from 15~235.</li> <li>• Auto: Sets the projector to detect the range of the input signal automatically.</li> </ul>
3D Settings	<p>Enables you to enjoy 3D movies, videos, and sporting events in a more realistic way by presenting the depth of the images while wearing 3D glasses.</p> <p><b><u>3D Sync</u></b></p> <p>Adjust and choose from: Auto, Disable, Frame Sequential, Frame Packing, Top-Bottom, Side-by-Side.</p> <p><b><u>3D Sync Invert</u></b></p> <p>Allows for correction if the 3D image depth is inversed.</p>
harman/kardon	Adjust the audio settings.
Information	Shows Input Source and Resolution.



# > Operating the Projector

This section will introduce the **Home Screen** and its menus.

## Home Screen

The **Home Screen** is displayed every time you start the projector. To navigate the **Home Screen**, simply use the directional buttons on the remote control. You can return to the main **Home Screen** at any time by pressing the **Home** button on the remote control, regardless of what page you are on.

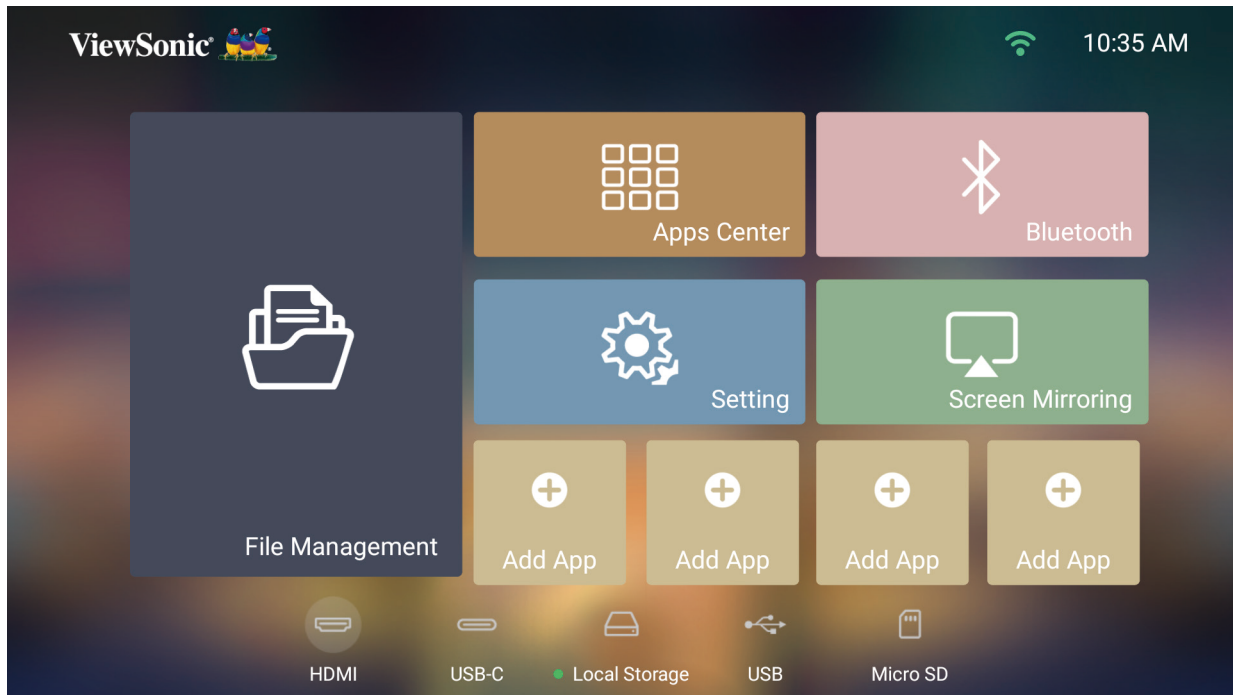

Menu	Description
File Management	Provides a user interface to manage files and folders.
Apps Center	Access and view all the applications you have installed.
Bluetooth	Select the appropriate Bluetooth mode.
Setting	Manage various categories such as: Network settings, Basic and Advanced settings, Date & Time, Firmware update, and System Information.
Screen Mirroring	Mirror your personal device's screen through the projector.
Add App	Select your favorite Apps and add them to the <b>Home Screen</b> .

# Home Screen - On-Screen Display (OSD) Menu Tree

Main Menu	Sub-menu	Menu Option		
File Management				
Apps Center				
Bluetooth				
Setting	Network Settings	Wi-Fi	Enable/Disable	
			SSID	
			Configure IP	
			IP Address	
			Subnet Mask	
			Default Gateway	
			DNS Server	
	Basic Settings	Language	English	
			French	
			German	
			Italian	
			Spanish	
			Russian	
			繁體中文	
			簡體中文	
			日本語	
			韓語	
			Swedish	
			Dutch	
			Turkish	
			Czech	
			Portuguese	
			Thai	
			Polish	
			Finnish	
			Arabic	
			Indonesian	
			Hindi	
			Vietnam	
			Greek	

Main Menu	Sub-menu	Menu Option			
Setting	Basic Settings	Projector Projection	Front Table		
			Front Ceiling		
			Rear Table		
			Rear Ceiling		
		Keystone	Auto Keystone	Disable	
				Enable	
			V Keystone	(-/+ , -40~40)	
			H Keystone	(-/+ , -40~40)	
			4 Corner Adjustment	Disable	
			Enable		
		Zoom	0.8x~1.0x		
		Focus	Manual Focus		
			Auto Focus	Disable	
	Enable				
	Date & Time	Automatic Date & Time	Disable		
			Enable		
		Date			
		Time			
		Time Zone			
		Time Format	12 Hours		
	24 Hours				
	Firmware Update	Software Update Online			
		Software Update by USB			
		OTA Reminder	Enable		
			Disable		
		Software Version			

Main Menu	Sub-menu	Menu Option			
Setting	Advanced Settings	Power On Source	Disable		
			HDMI		
			USB-C		
		Power On/Off Ring Tone	Disable		
			Enable		
		Auto Power On	CEC		Disable
					Enable
		Smart Energy	Auto Power Off		Disable
					10 minutes
				20 minutes	
				30 minutes	
			Sleep Timer	Disable	
				30 minutes	
				1 hour	
				2 hours	
				3 hours	
				4 hours	
				8 hours	
			12 hours		
			Power Saving	Disable	
				Enable	
		harman/kardon	Audio Mode	Movie	
				Music	
				User	
				100Hz	
				500Hz	
				1500Hz	
5000Hz					
10000Hz					
Audio Volume	(0~50)				
Mute	Disable				
	Enable				
Light Source Level	Full				
	Eco				

Main Menu	Sub-menu	Menu Option	
<b>Setting</b>	Advanced Settings	High Altitude Mode	Disable
			Enable
		Reset Settings	Reset
			Cancel
		Reset to Factory Default	Reset
			Cancel
	Information	Light Source Hours	
		System Version	
		Memory Information	XX GB of XX GB Used
		Wi-Fi Mac Address	
		Serial Number	
<b>Screen Mirroring</b>			
<b>Add App</b>			
<b>Add App</b>			
<b>Add App</b>			
<b>Add App</b>			

# Menu Operations

## File Management

Easily manage files and folders.

1. Select: **Home > File Management.**

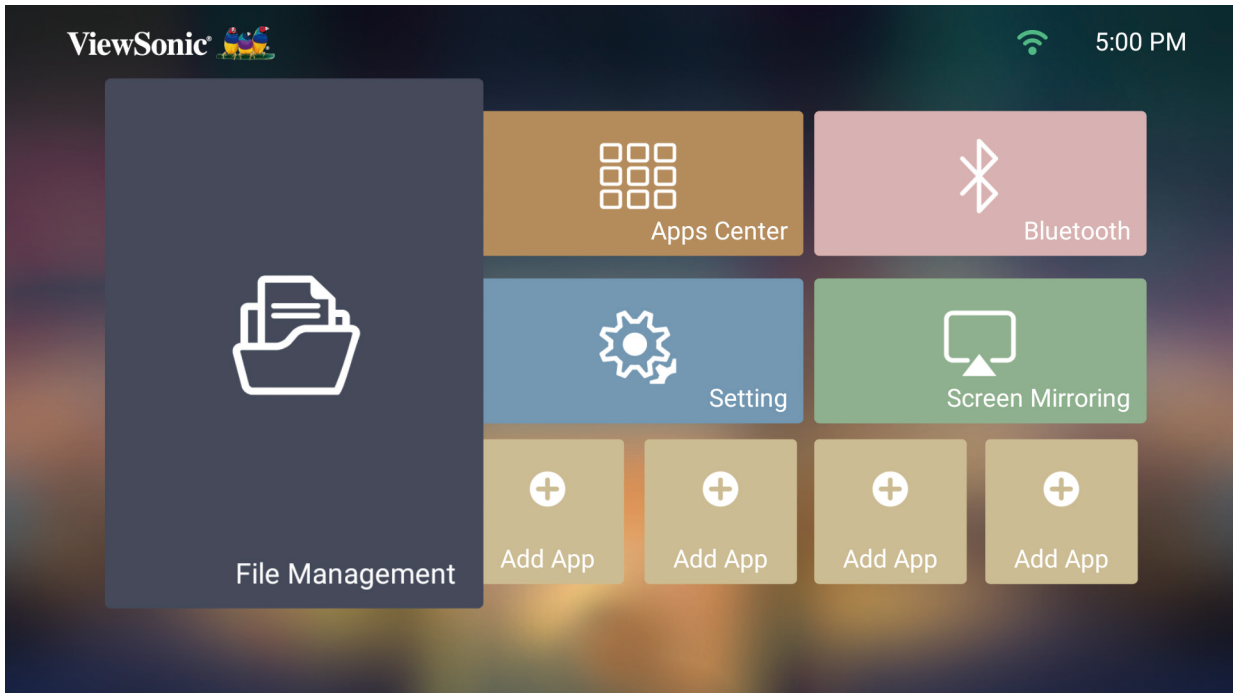

2. Select a device on the source list: USB, Local Storage, MicroSD, etc. Use the direction buttons to select the desired file. Then press **OK** on the remote control to open the selected file.



3. Press the **Return** button to go to a previous a level.

**NOTE:** Press the **Home** button on the remote control to return to the **Home Screen** at anytime.

## How to Edit a File

1. While in **File Management**, press and hold the **OK** button for three (3) seconds.
2. A check box will appear at the front of each file. Use the direction buttons and press **OK** to select one or more files.

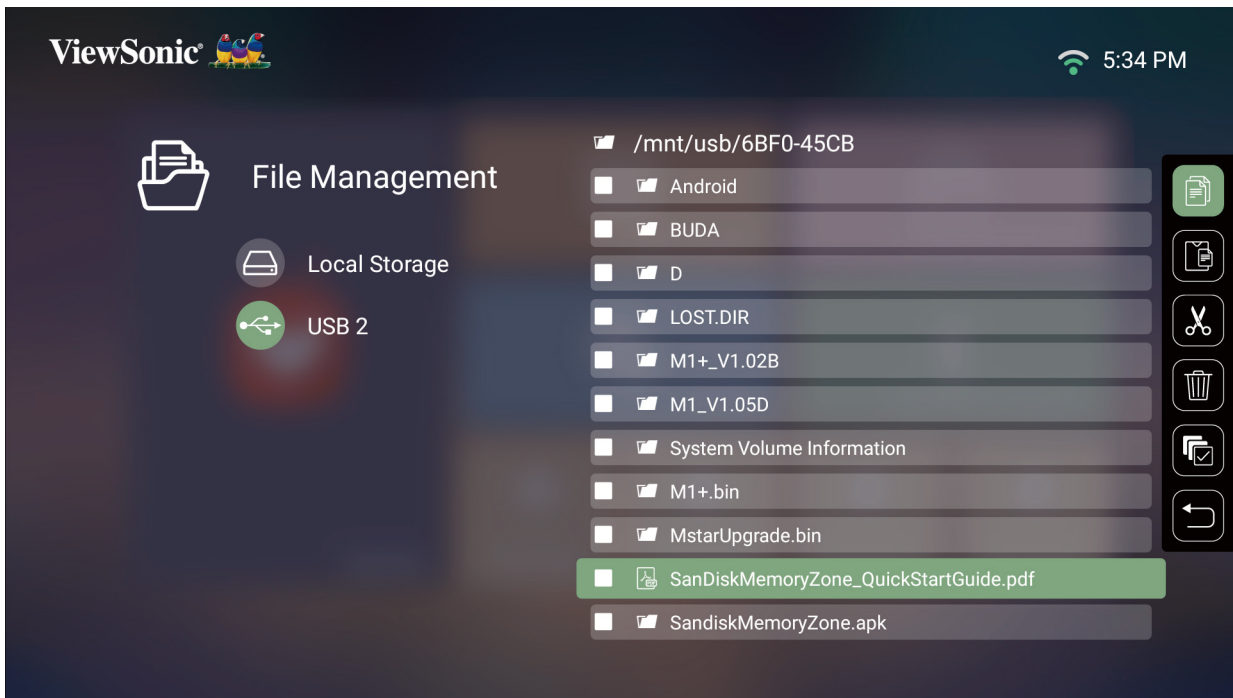



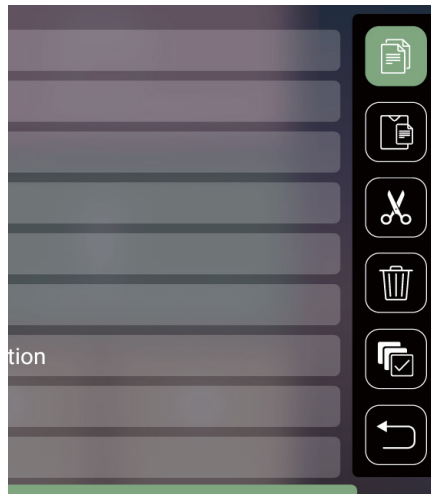



















3. By pressing the **Right** button, Copy, Paste, Cut, Delete, Select All, and Return boxes will be available for use.



4. Select your desired action and press **OK** to execute.
5. If you are Copying or Cutting, select your destination folder to complete the process.

## How to Use Control Bar Buttons

The Control Bar buttons will appear on screen if a video, music, or photo file are selected to be opened.

Picture		Video		Music	
	Back		Back		Back
	Play		Rewind		Play
	Next		Play		Pause
	Zoom in		Pause		Next
	Zoom out		Fast Forward		Shuffle
	Rotate (left)		Next		Repeat All
	Rotate (right)		Volume Control		Repeat One
					Play List
					Information

## Tips for Using USB

When using USB for reading and/or storage please keep in mind the following:

1. Some USB storage devices may not be compatible.
2. If you use an USB extension cable, the USB device may not recognize the USB.
3. Only use USB storage devices formatted with Windows FAT32 or NTFS file system.
4. Larger files will need extra time to load.
5. Data on USB storage devices may be damaged or lost. Back up important files.



## Supported File Formats

Supported Office formats:

	Item	Indicators
<b>Document viewing function</b>	doc/docx	Able to open and read documents in doc/docx
	xls/xlsx	Able to open and read documents in xls/xlsx
	ppt/pptx	Able to open and read documents in ppt/pptx
	Pdf	Able to open and read documents in pdf
<b>Supporting Interface Language</b>	Supporting Interface 44 languages	English, Simplified Chinese, Chinese (TW), Chinese (HK), Spanish (LA), French (EU), PT (EU), PT (BR), German, Russian, Italian, Swedish, Spanish (EU), Korean, Arabic, Farsi, Serbian, Bosnian, Macedonian, Bulgarian, Ukrainian, Greek, Norwegian, Danish, Czech, Hungarian, Slovak, Polish, Romanian, Finnish, Estonian, Latvian, Lithuanian, British English, Slovenian, Croatian, Turkish, Vietnamese, Bahasa Indonesia, Dutch, Malay, Thai, Hindi, Hebrew, Burmese, Catalan.

Supported Multimedia formats:

Extension	Type	Codec
.xvid	Video	Xvid, H.264
.avi	Audio	MP3
.mp4	Video	H.264/MPEG 4
.m4v	Audio	AAC
.mov		
.mkv	Video	H.264
.ts	Video	H.264, MPEG2
.trp	Audio	MP3/AAC
.tp		
.mts		
.m2ts		
.vob	Video	MPEG1, MPEG2
	Audio	DVD-LPCM
.mpg	Video	MPEG1

## Supported External Connected Device formats:

Device	Supported Size (Max. Size)	NTFS Format		FAT32 Format		exFAT	
		Read	Write	Read	Write	Read	Write
USB Memory Stick	256 GB	V	N/A	V	V	N/A	N/A
USB HDD	2 TB	V	N/A	V	V	N/A	N/A
Micro SD	256 GB	V	N/A	V	V	N/A	N/A

### NOTE:

- Windows 10 built-in format tool only supports FAT32 format up to 32 GB.
- Firmware upgrade only supports FAT32 format.

## Apps Center

View, launch, and uninstall Apps.

1. To view your Apps, select: **Home > Apps Center**.

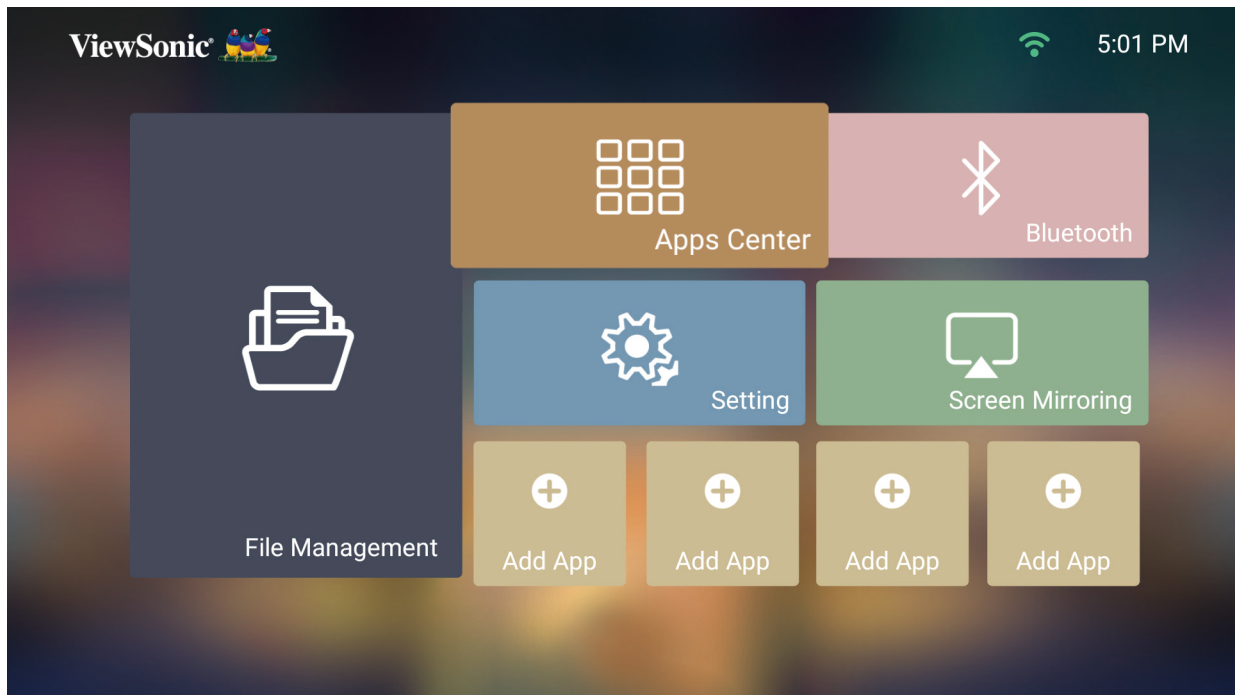

2. Use the direction buttons to select the desired App. Then press **OK** on the remote control to launch the App.

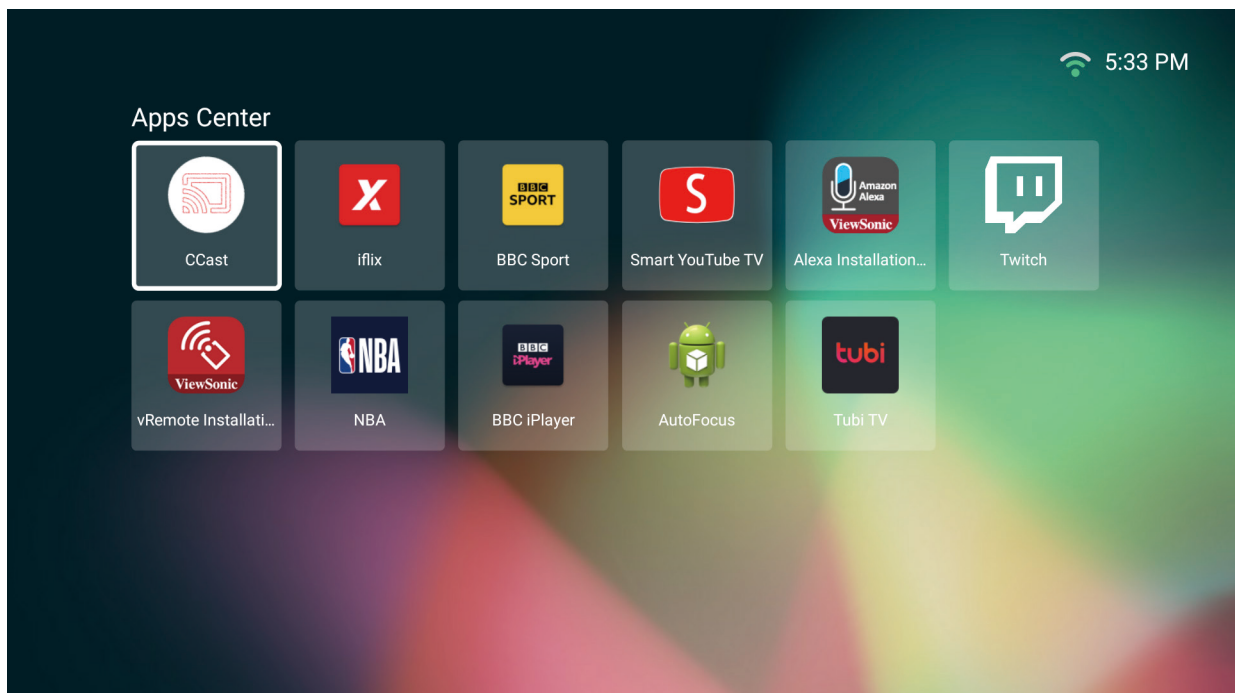

**NOTE:** Press the **Home** button on the remote control to return to the **Home Screen** at anytime.

## To Uninstall Apps

1. Open the **Apps Center** by selecting: **Home > Apps Center**.
2. Use the directional buttons to select the desired App.
3. Press and hold **OK** on the remote control for three (3) seconds. The below dialogue box will appear:

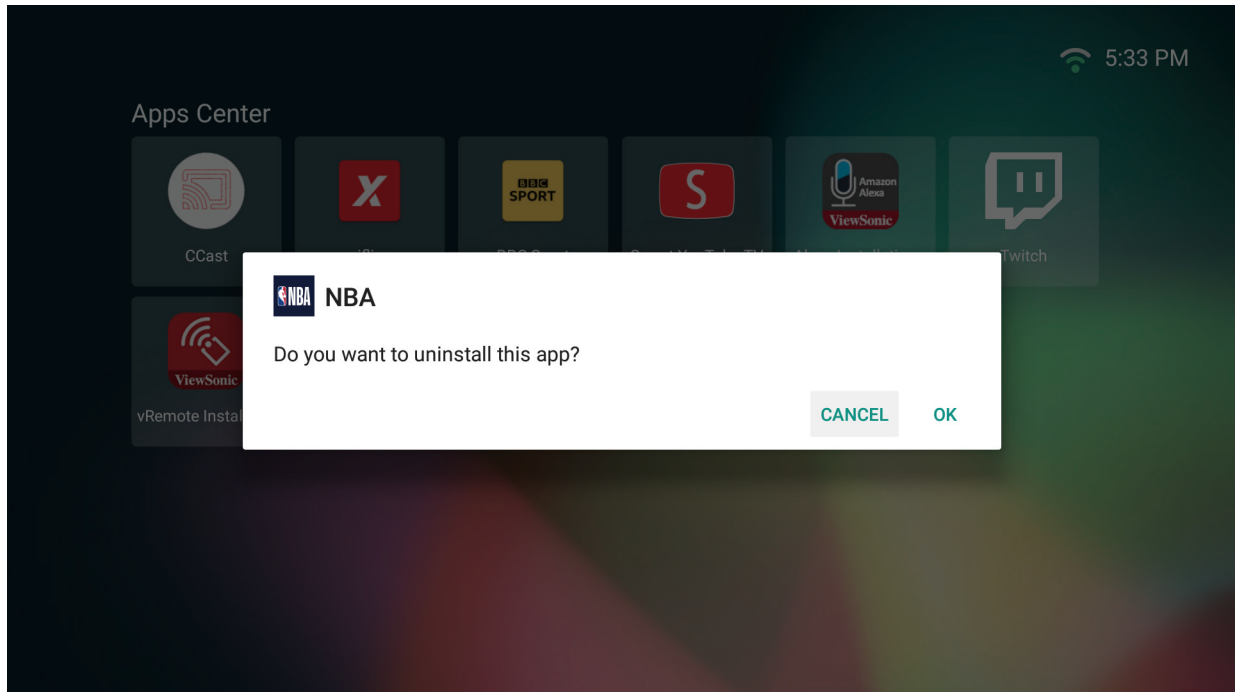

4. Select **OK** to uninstall the App.

**NOTE:** Press the **Home** button on the remote control to return to the **Home Screen** at anytime.

## Bluetooth

The projector is equipped with Bluetooth that allows the user to connect their device wirelessly for audio playback. For more information, see page 21.

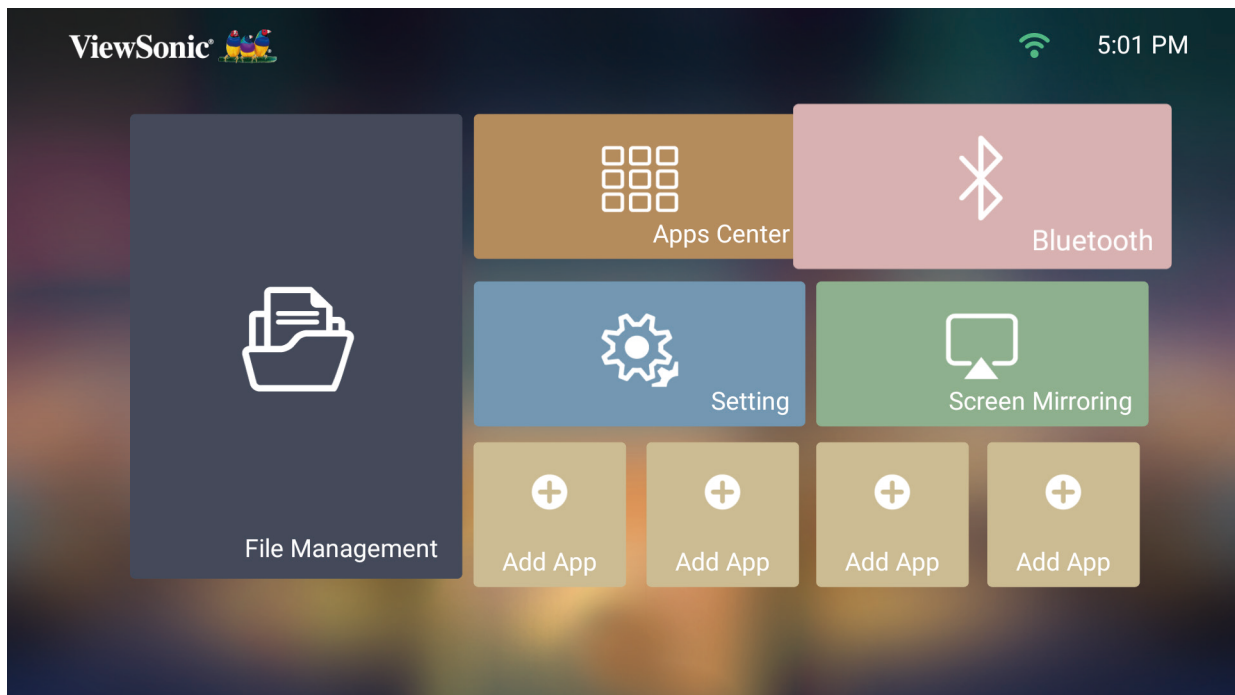

## Setting

Under **Setting** you can adjust Network, Basic, and Advanced Settings, Date & Time, Firmware Update, and view Information.

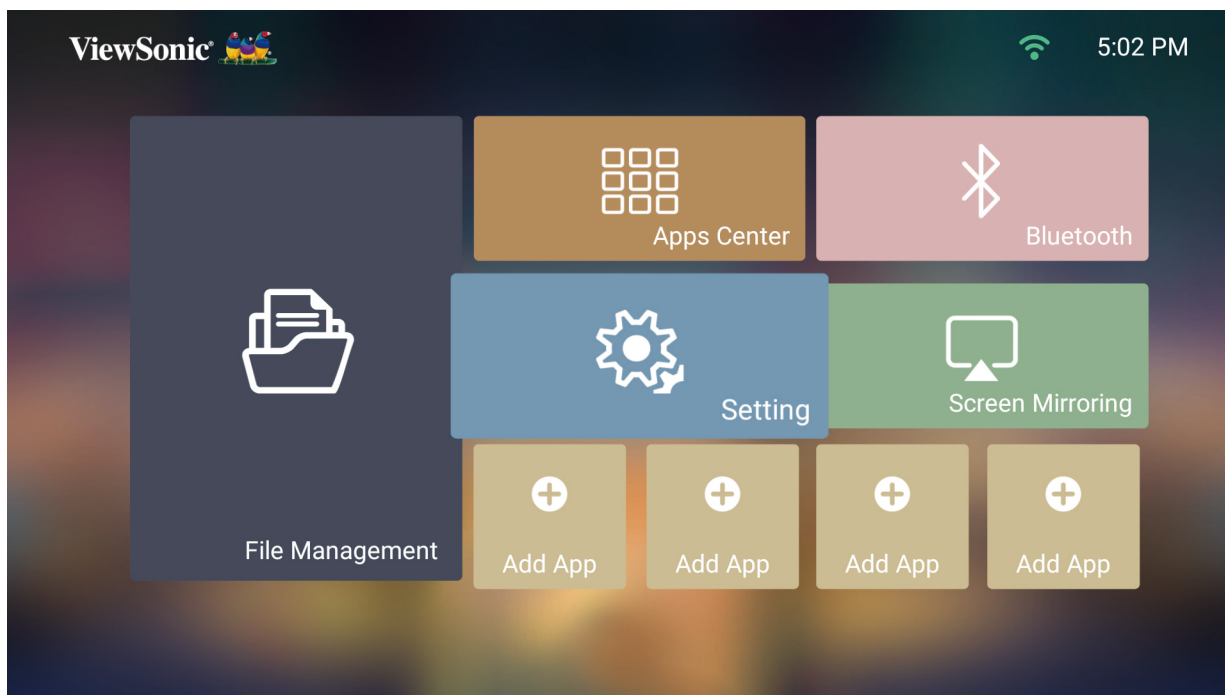

## Network Settings

1. Select: **Home > Setting > Network Settings.**

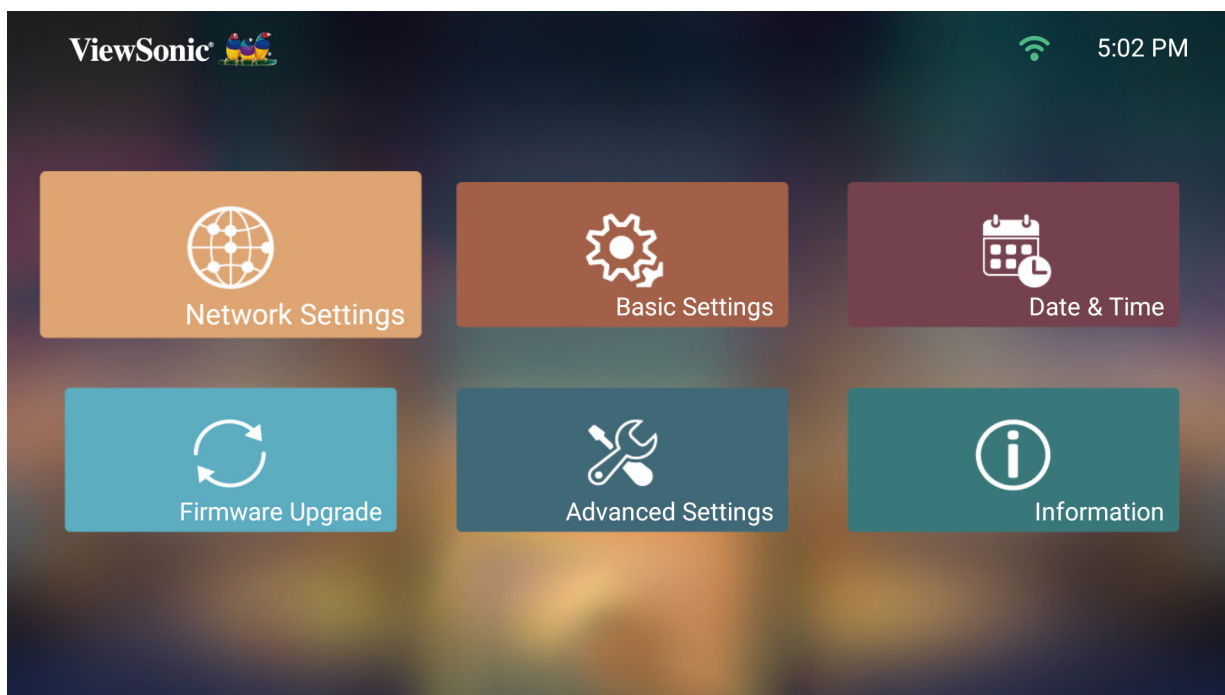

**2. View and adjust your Wi-Fi and network settings.**



**3. To setup a Wireless connection, see “Connecting to Networks” on page 24.**



## Basic Settings

1. Select: **Home** > **Setting** > **Basic Settings**.

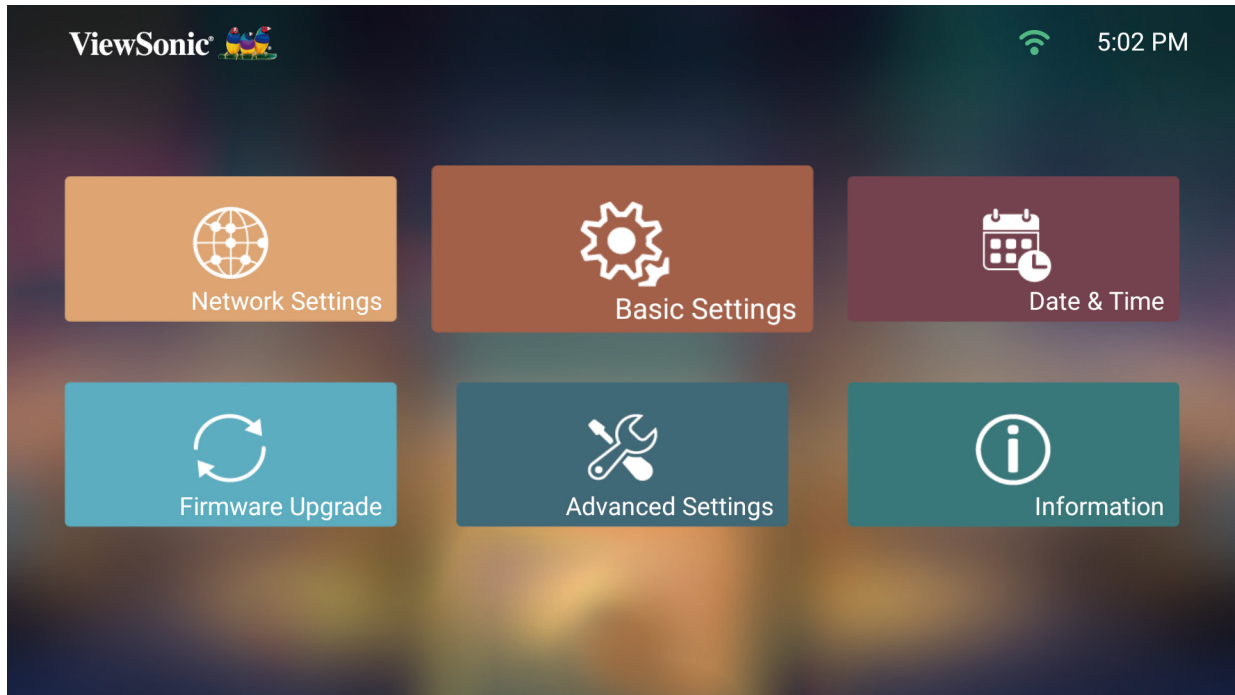

2. Use the **Up** and **Down** buttons to select the desired option and press **OK**, or use the **Left** and **Right** buttons to make adjustments or selections.

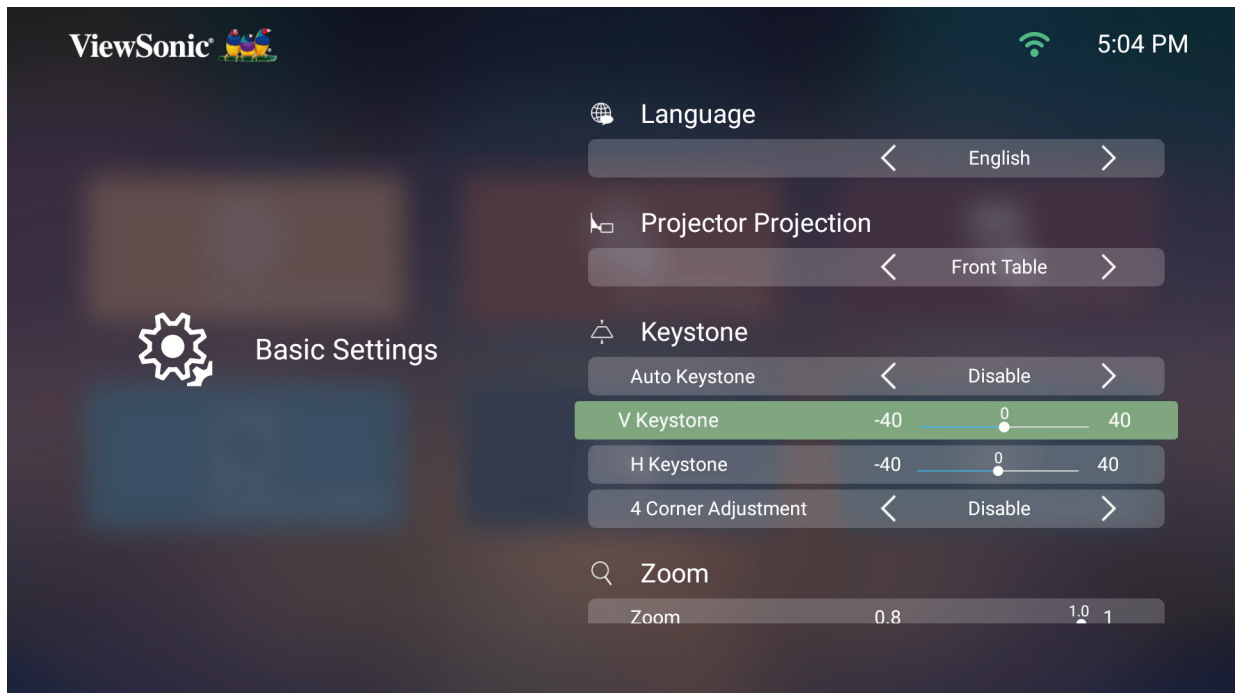





3. To return to a previous menu press the **Return** button.

Menu	Description
Language	Select your desired language.
Projector Position	Select the preferred projection position.

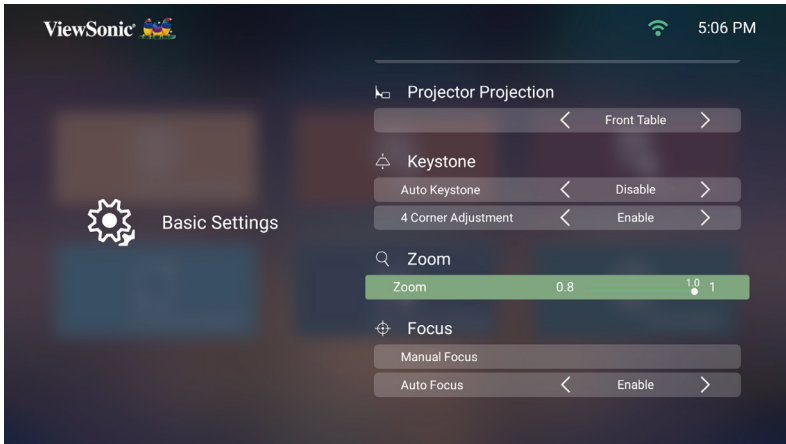
Menu	Description
Keystone	<p>Adjust trapezoidal screen image distortion.</p> <p><b><u>Auto Keystone</u></b> Provides a rectangular screen image by automatically adjusting the keystone number when there is a trapezoidal screen image caused by the tilting of the projector.</p> <ul style="list-style-type: none"> <li>• <b>Enable:</b> Automatically adjust the keystone number.</li> <li>• <b>Disable:</b> Manually adjust the keystone number.</li> </ul> <p><b><u>Horizontal Keystone</u></b> Keystone can be adjusted horizontally manually.</p> <p><b><u>Vertical Keystone</u></b> Keystone can be adjusted vertically manually.</p> <p><b><u>4 Corner Adjustment</u></b> Adjust each corner individually for maximum projection flexibility.</p> 
Zoom	<p>Activate the zoom function.</p> 

Menu	Description
Focus	<p>Adjust the focus of the screen image.</p> <p><b><u>Manual Focus</u></b></p> <p>Adjust the focus with the <b>Left</b> and <b>Right</b> buttons on the remote control.</p> <div data-bbox="632 409 1369 846" data-label="Image"> </div> <p><b><u>Auto Focus</u></b></p> <p>Choose from the following:</p> <ul style="list-style-type: none"> <li>• <b>Enable:</b> Automatically adjust the focus instantly without the remote control.</li> <li>• <b>Disable:</b> Manually adjust the focus.</li> </ul> <p><b>NOTE:</b> If <b>Auto Focus</b> is <b>Enabled</b>, the projector will automatically focus the screen image when turned on or the position or angle of the projector is adjusted.</p>

## Date & Time

Adjust Date, Time, Time Zone, and Time Format.

**NOTE:** The time is displayed in the top-right corner after connecting to the Internet.

1. Select: **Home > Setting > Date & Time.**

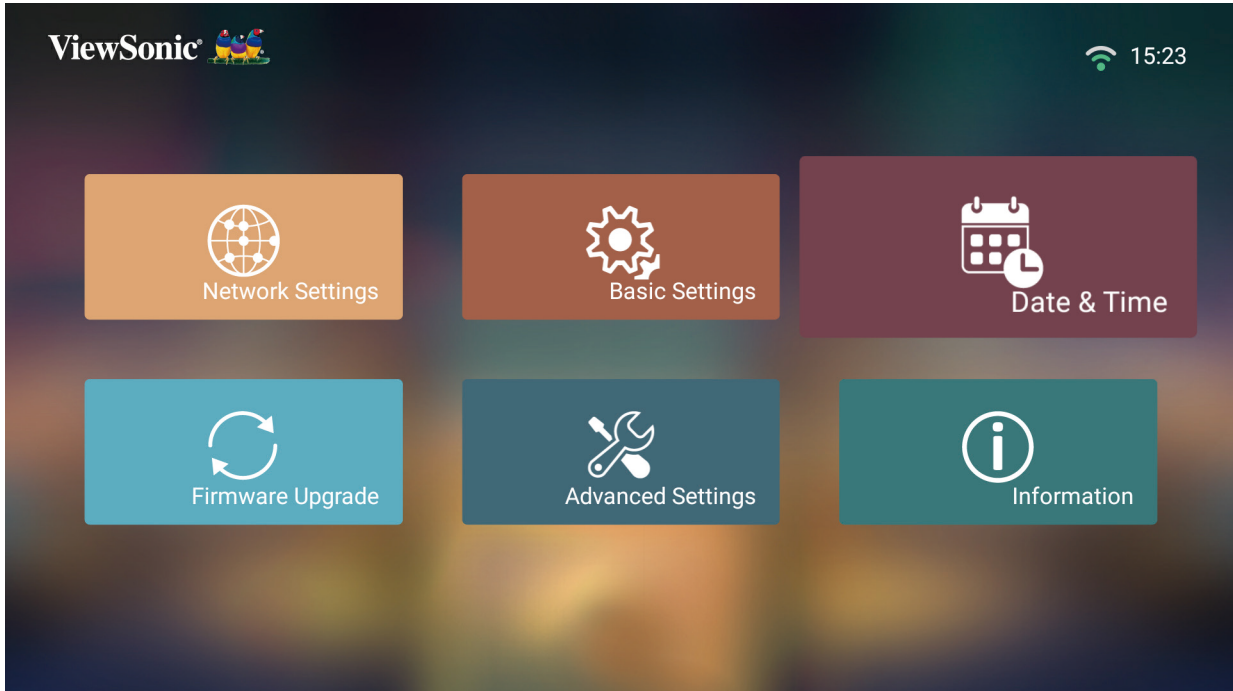

2. Use the **Up** and **Down** buttons to select the desired option and press **OK**, or use the **Left** and **Right** buttons to make adjustments or selections.

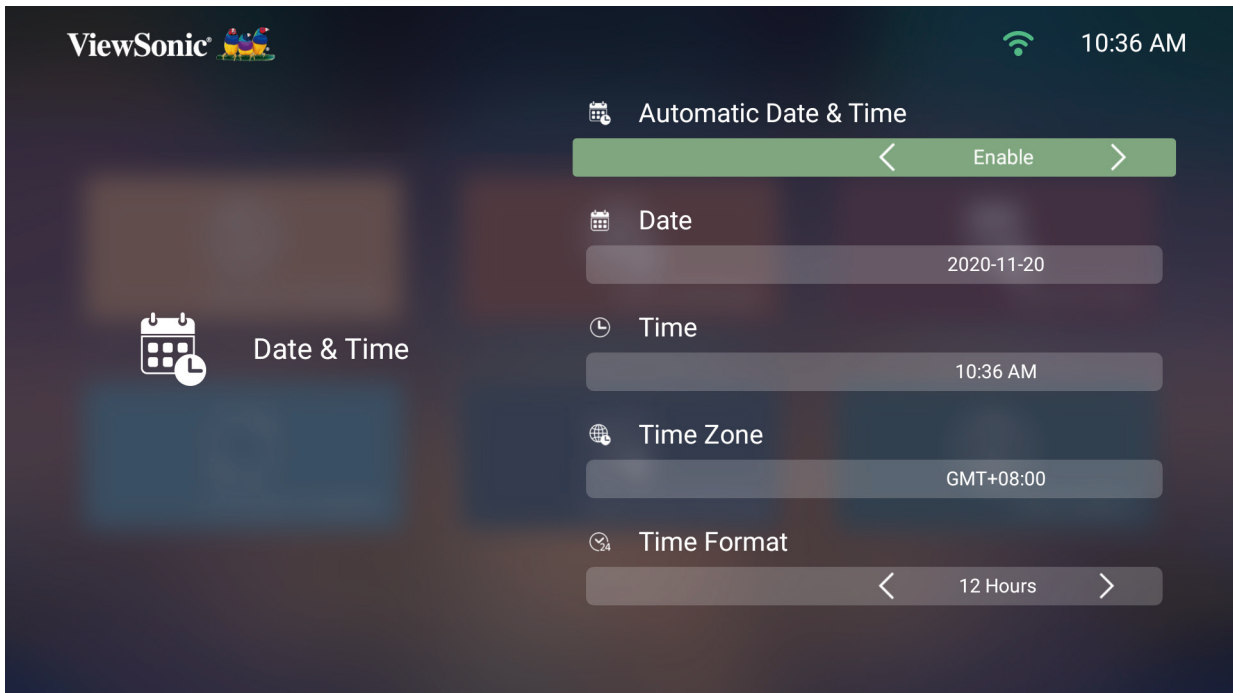

Menu	Description
Automatic Date & Time	<p>Users can synchronize the date and time automatically after connecting to the Internet.</p> <p><b><u>Enable</u></b> Turn on synchronization.</p> <p><b><u>Disable</u></b> Turn off synchronization.</p>
Time Zone	Select your desired location.
Time Format	<p>Select a different display time format.</p> <p><b><u>12 Hours</u></b> 12-hour clock.</p> <p><b><u>24 Hours</u></b> 24-hour clock.</p>

## Firmware Upgrade

Users can update the firmware Online, or by USB, and check the version number.

**NOTE:** Do not unplug the power cord, USB, or disconnect from the Internet during the upgrading process.

1. Before entering the **Firmware Upgrade** menu, ensure the projector is connected to the Internet.
2. To enter the menu, select: **Home > Setting > Firmware Upgrade**.

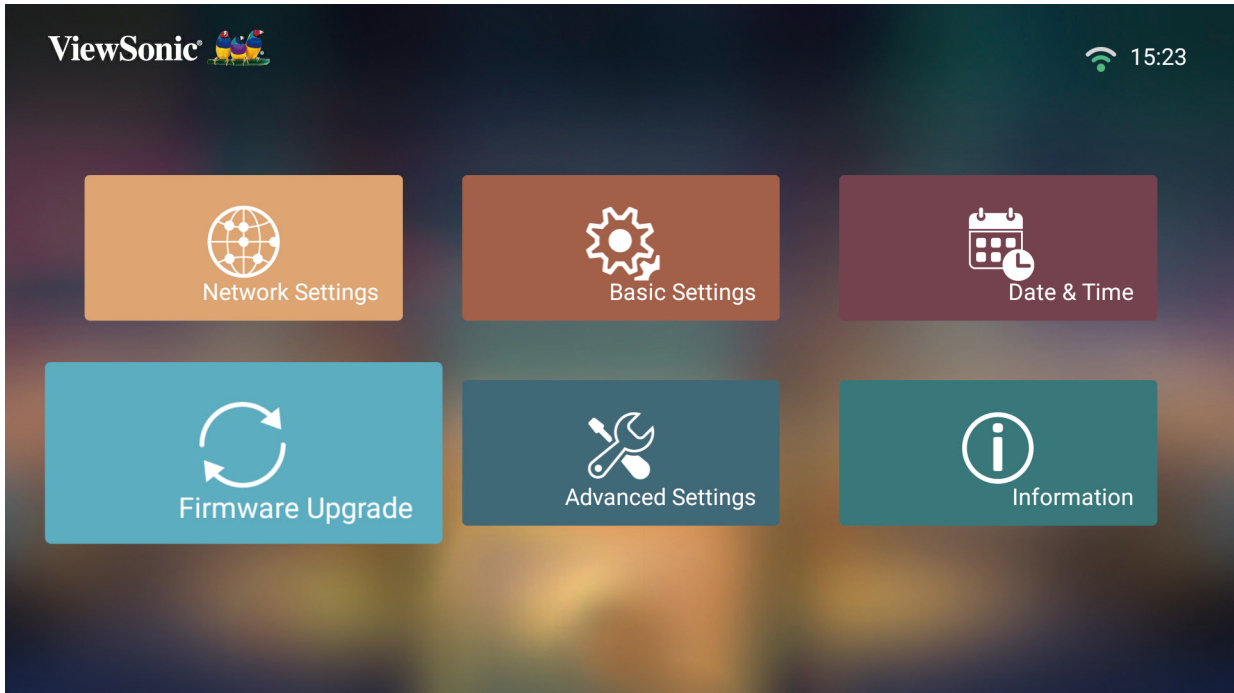

## Firmware Update Online

1. Go to: **Home > Setting > Firmware Upgrade > Software Update Online**.

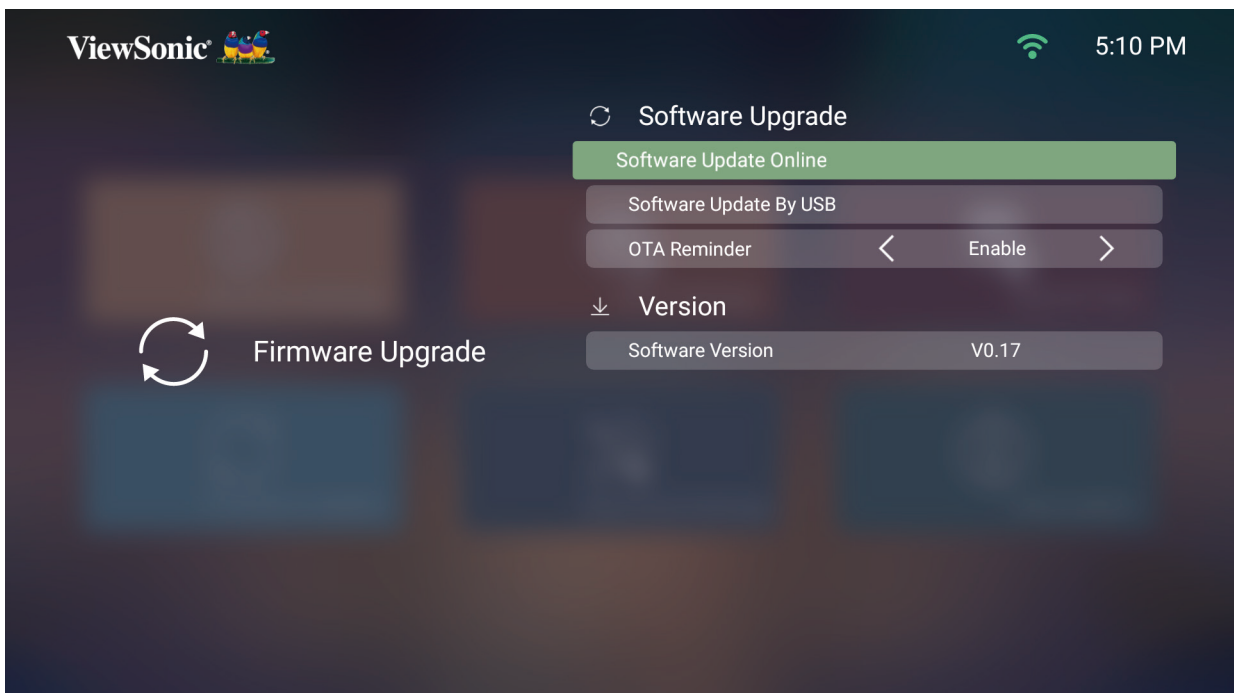

2. Select **Enter** by pressing **OK** on the remote control.
3. The system will check the ViewSonic website (OTA) and display the below dialog message if there is new Firmware.



4. By selecting **Yes**, a progress bar will appear as the update process begins.

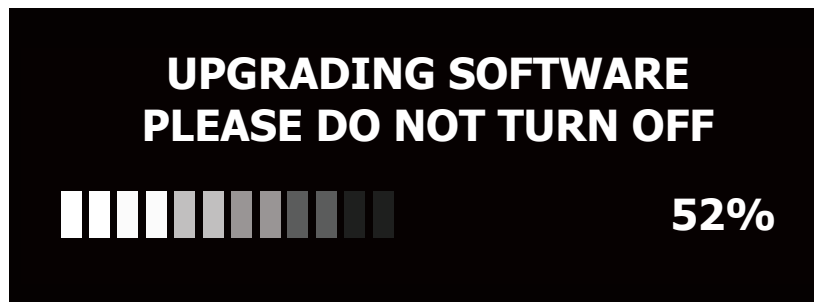

5. Upon reaching 100%, the projector will restart. The whole process will take about 10 minutes.
6. After updating the Firmware, it will take a few minutes to restart the projector.



## Firmware Update by USB

1. Download the latest version from the ViewSonic website and copy the file to a USB device.
2. Plug the USB into the projector, then go to: **Home > Setting > Firmware Upgrade > Software Update By USB.**
3. Select **Enter** by pressing **OK** on the remote control.

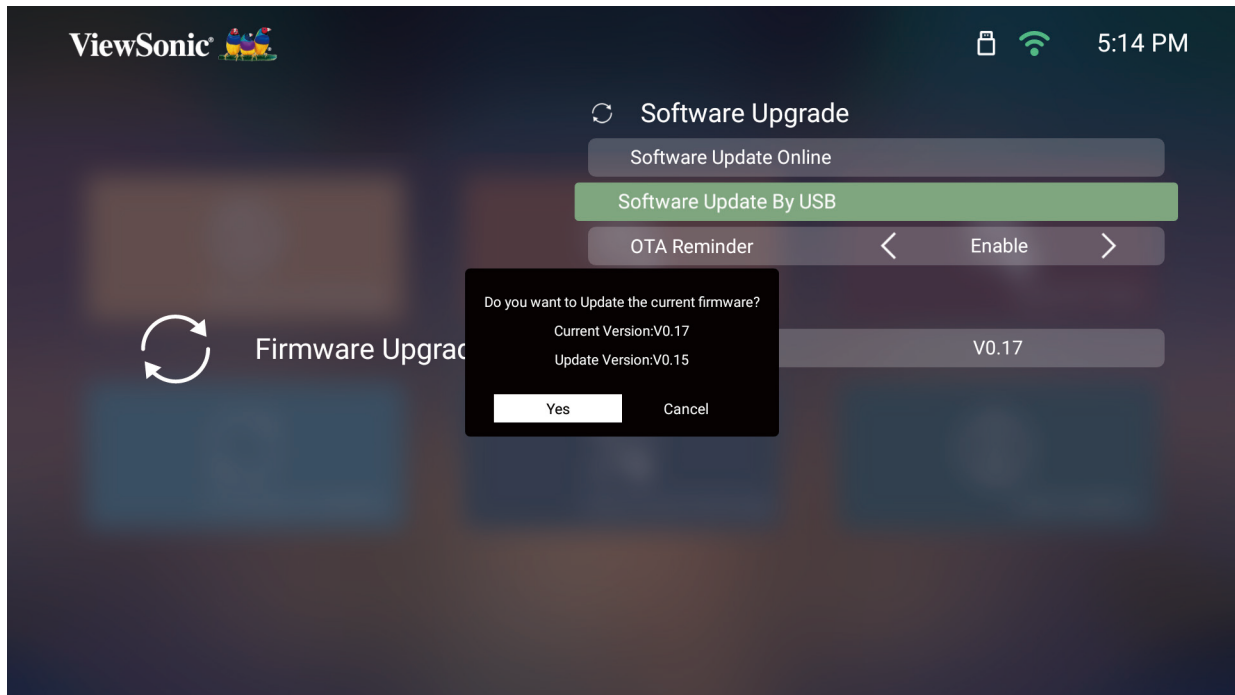

4. The system will detect the Firmware version and display the above dialog message.
5. By selecting **Yes**, a progress bar will appear as the update process begins.
6. After reaching 100%, the projector will restart. The whole process will take about 10 minutes.
7. After updating the Firmware, it will take a few minutes to restart the projector.



## Advanced Settings

1. Select: **Home > Setting > Advanced Settings.**

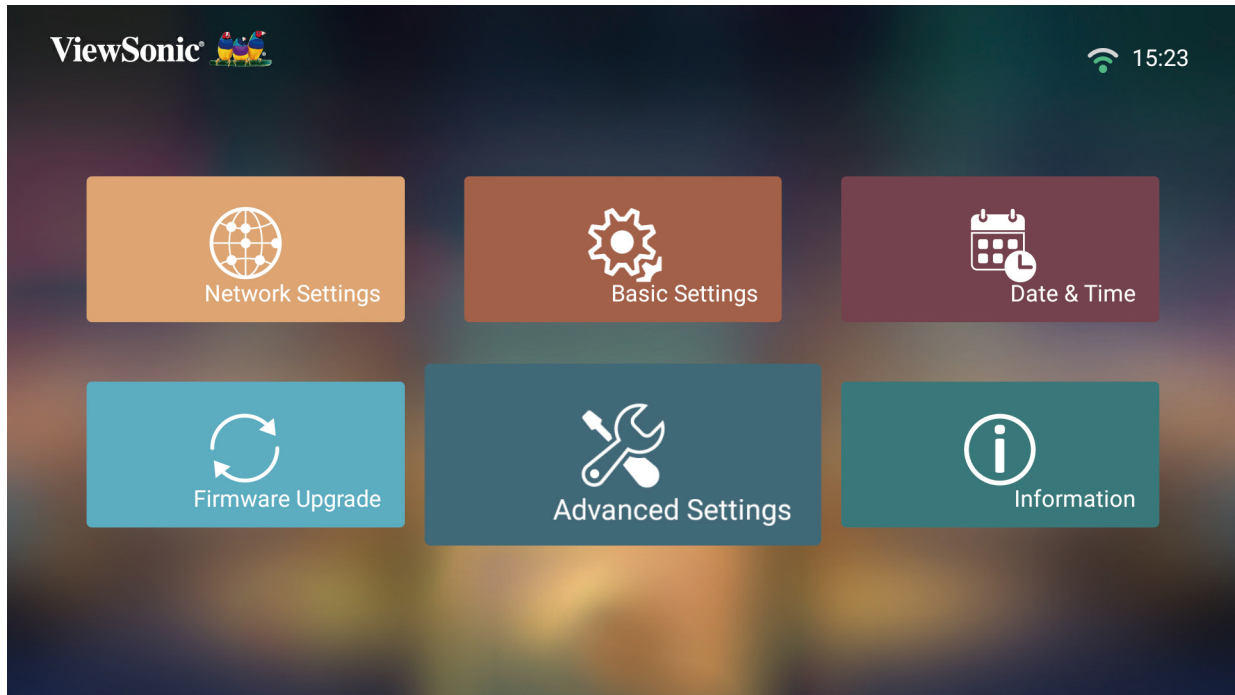

2. Use the **Up** and **Down** buttons to select the desired option and press **OK**, or use the **Left** and **Right** buttons to make adjustments or selections.



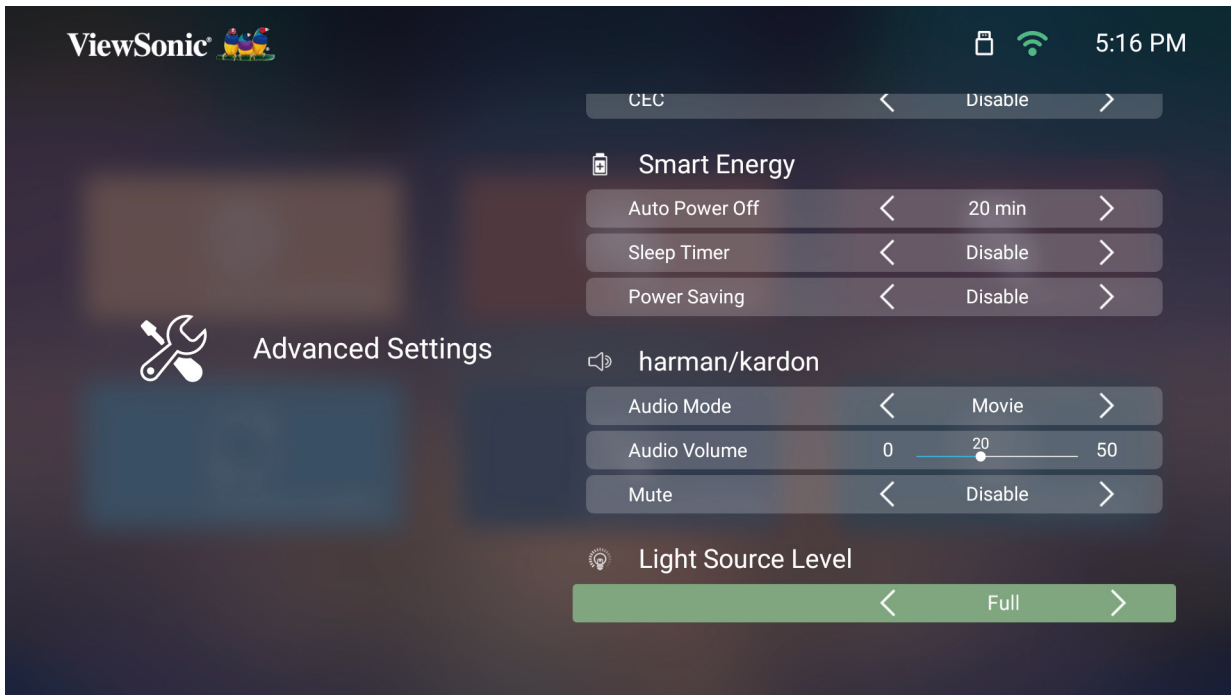

3. To return to a previous menu press the **Return** button.

Menu	Description
Power On Source	Allows the user to enter the desired source directly after turning on the projector.
Power On/Off Ring Tone	Enable or disable the power on/off ring tone.
Auto Power On	<p><b>CEC</b></p> <p>This projector supports the CEC (Consumer Electronics Control) function for synchronized power on/off operation via HDMI connection.</p> <p>That is, if a device that also supports the CEC function is connected to the HDMI input of the projector, when the projector's power is turned off, the power of the connected device will also be turned off automatically. When the power of the connected device is turned on, the projector's power will be turned on automatically.</p> <p><b>NOTE:</b> Ensure both the projector's and the connected device's CEC function are turned on.</p>

Menu	Description
Smart Energy	<p><b><u>Auto Power Off</u></b> The projector can turn off automatically after a set period of time once no input source is detected.</p> <p><b><u>Sleep Timer</u></b> Turn off automatically after a set period of time.</p> <p><b><u>Power Saving</u></b> Lower power consumption if no input source is detected after five (5) minutes.</p> <p><b>NOTE:</b> The power consumption of the LED will be changed to 30% after no signal is detected for five (5) minutes.</p>
harmon/kardon	<p><b><u>Audio Mode</u></b></p> <ul style="list-style-type: none"> <li>• <b>Movie:</b> Default audio mode.</li> <li>• <b>Music:</b> Ideal for music playback.</li> <li>• <b>User:</b> Allows the user to customize the audio equalizer.</li> </ul> <p><b>NOTE:</b> In User mode, 100Hz, 500Hz, 1500Hz, 5000Hz, and 10000Hz can be selected.</p>  <p><b><u>Audio Volume</u></b> Adjust the volume from 0 to 50.</p> <p><b><u>Mute</u></b> Mute or unmute the volume.</p>

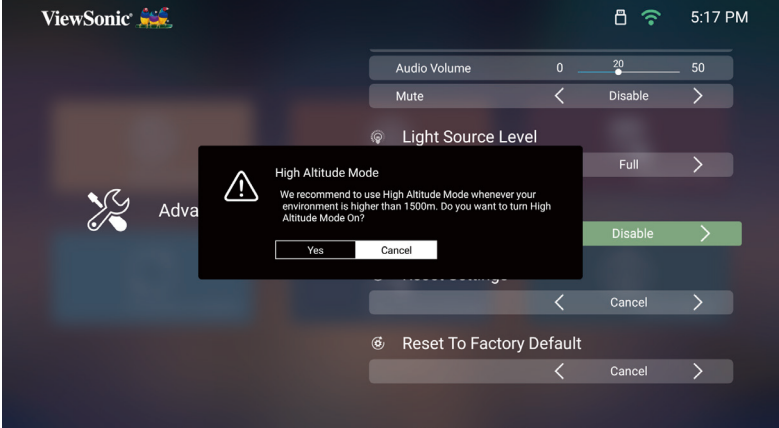
Menu	Description
Light Source Level	<p>Select the suitable power consumption of the LED.</p> <p><b>Full</b> 100%</p> <p><b>Eco</b> 70%</p> <p><b>NOTE:</b> If using a USB-C connected power bank to charge the M2e, the light source level will only have Full (50%) and Eco (30%) options.</p>
High Altitude Mode	<p>It is recommended that you use High Altitude Mode when your environment is between 1,500-3,000 m above sea level, and a temperature between 5°C-25°C.</p>  <p>The screenshot shows the projector's settings menu. At the top, it displays the ViewSonic logo, signal strength, Wi-Fi, and the time 5:17 PM. Below are sliders for Audio Volume (0 to 50) and a Mute button. The Light Source Level is set to Full. A modal dialog box is displayed in the center with a warning icon and the text: 'High Altitude Mode. We recommend to use High Altitude Mode whenever your environment is higher than 1500m. Do you want to turn High Altitude Mode On?'. The dialog has 'Yes' and 'Cancel' buttons. Below the dialog, there are buttons for 'Disable' (highlighted in green), 'Cancel', and 'Reset To Factory Default'.</p> <p><b>NOTE:</b> If you use this projector under other extreme conditions excluding the above, it may display auto shut-down symptoms, which is designed to protect your projector from over-heating. In cases like this, you should switch to High Altitude Mode to solve these symptoms. However, this is not to state that this projector can operate under any and all harsh or extreme conditions.</p>

Menu	Description
Reset Settings	Reset the Settings to default. <b>NOTE:</b> Language, High Altitude Mode, Projector Position, Network Settings, All installed Apps in the Apps Center, Add App, Bluetooth, Zoom, H/V Keystone, 4 Corner Adjustment, and Light Source Hours will remain unchanged.
Reset to Factory Default	Factory reset. <b>NOTE:</b> Light Source Hours will remain unchanged.

## Information

1. Select: **Home** > **Setting** > **Information**.

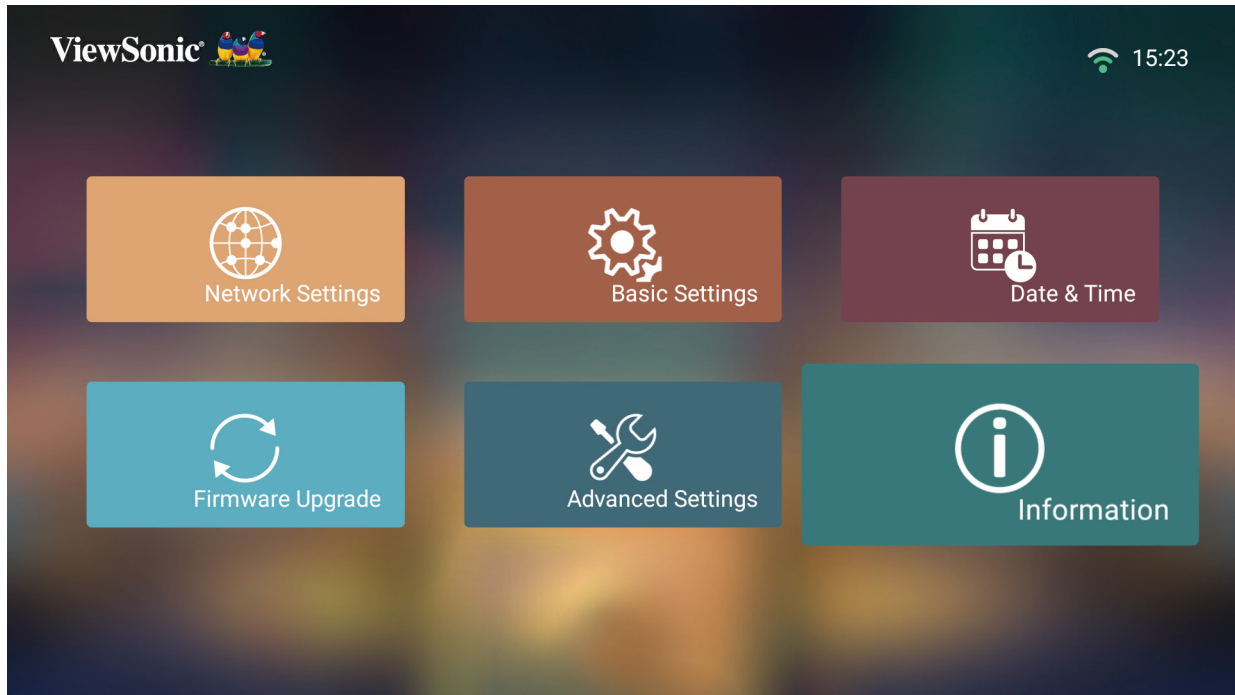

2. View system status and information.

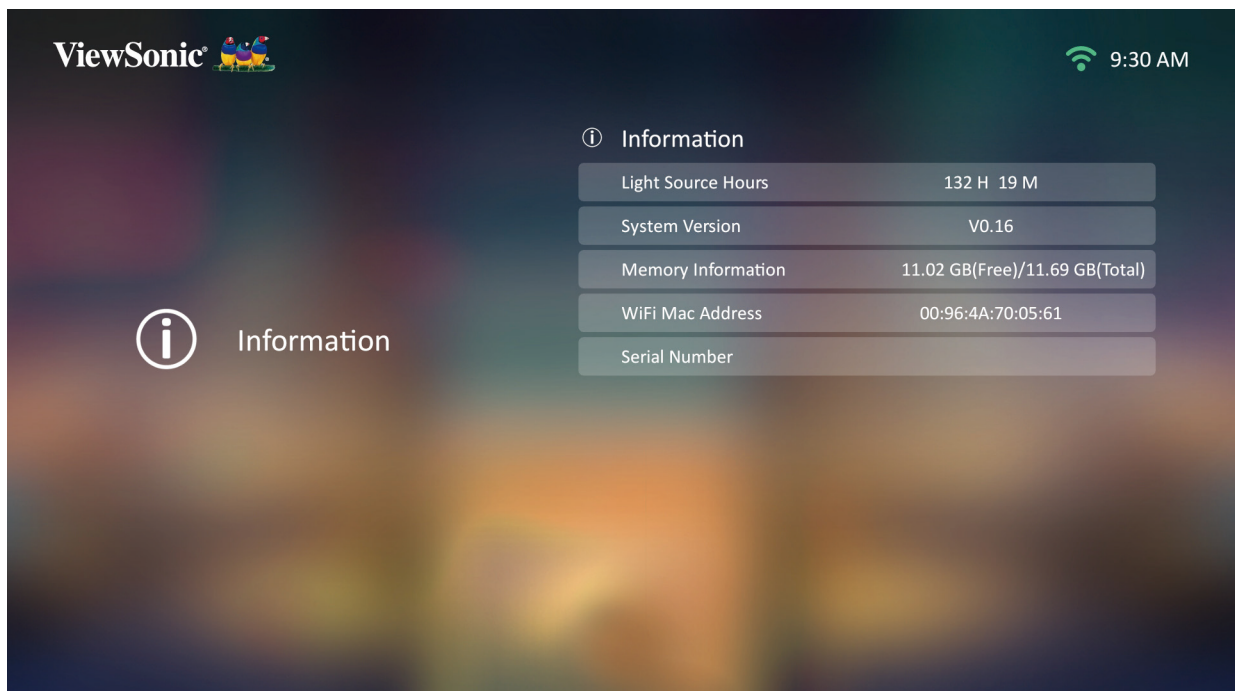

**NOTE:** Press the **Home** button on the remote control to return to the **Home Screen** at anytime.



## Screen Mirroring

Mirror your personal device's screen. To setup wireless Screen Mirroring, see "Wireless Screen Mirroring" on page 20.

**NOTE:** Ensure your device is connected to the same network as the projector.

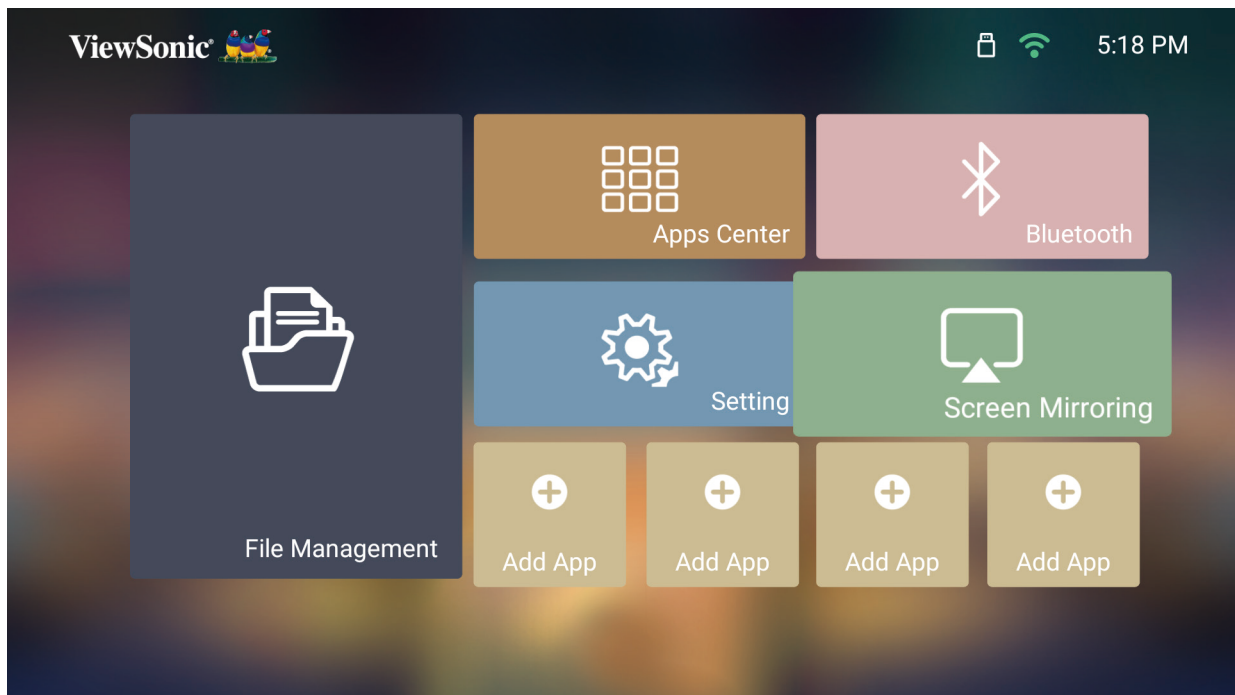

## Adding Apps

Add your favorite Apps to the **Home Screen**.

1. From the **Home Screen**, select **Add App** and then press **OK** on the remote control.

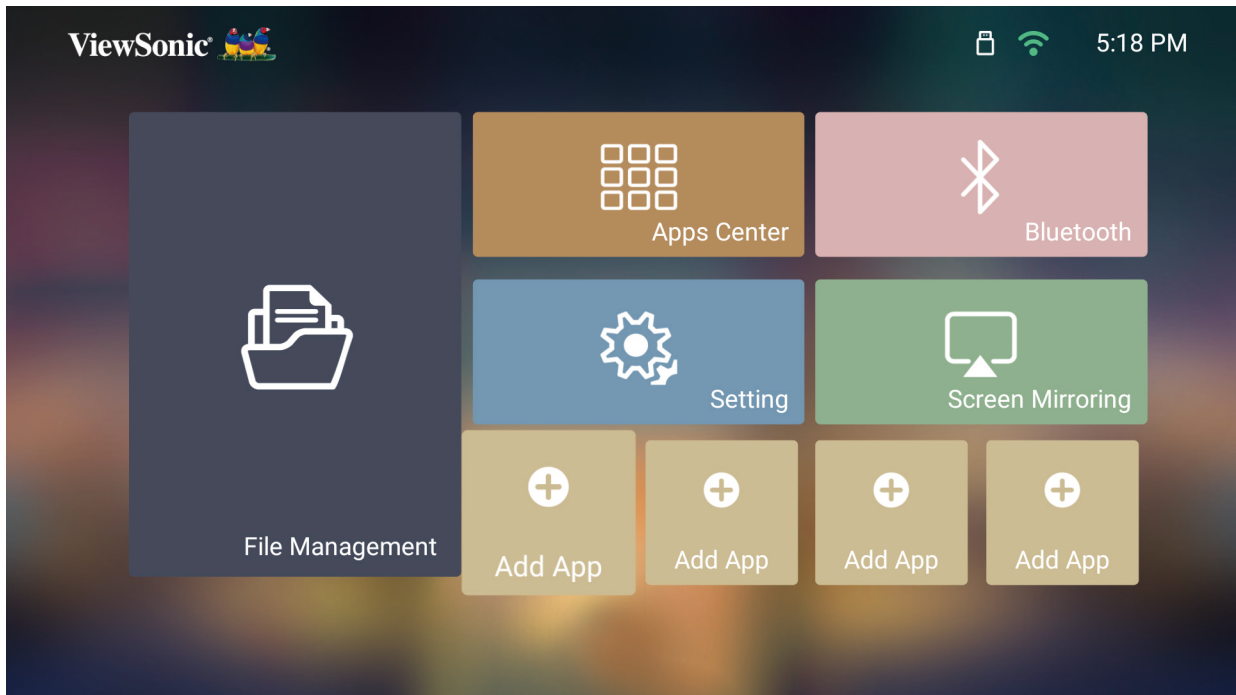

2. Use the directional buttons to select the desired App and press **OK**.

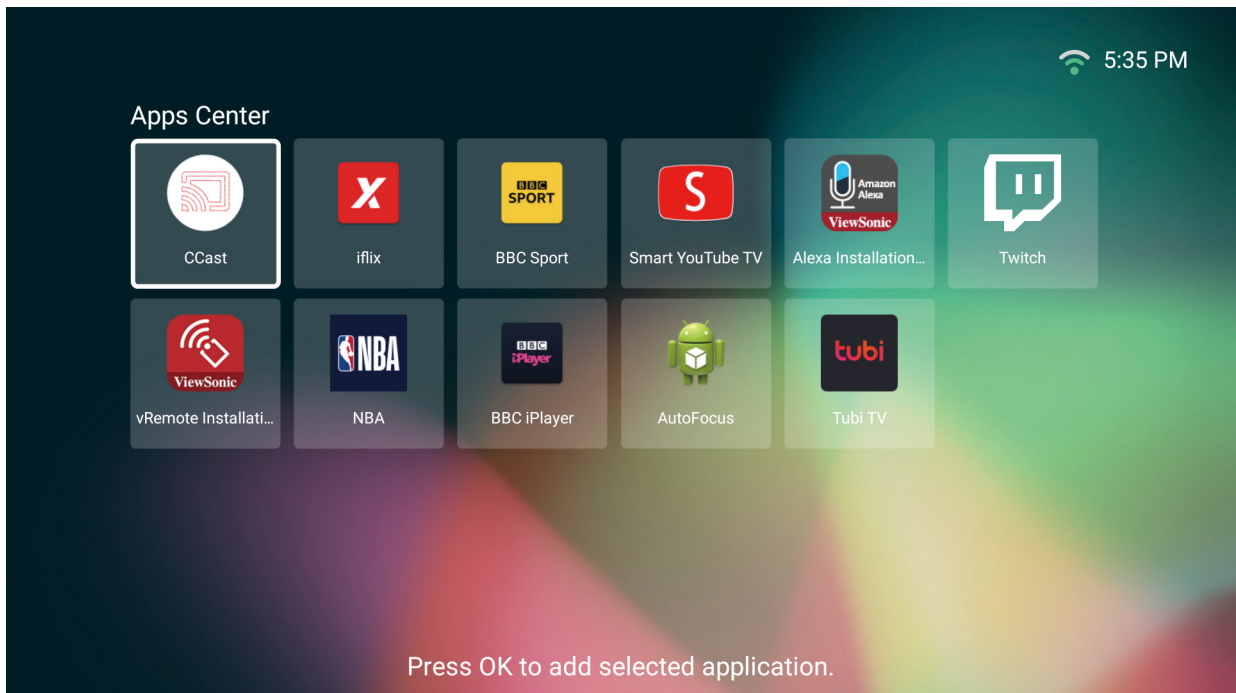



3. Now your favorite App will appear on the **Home Screen**.

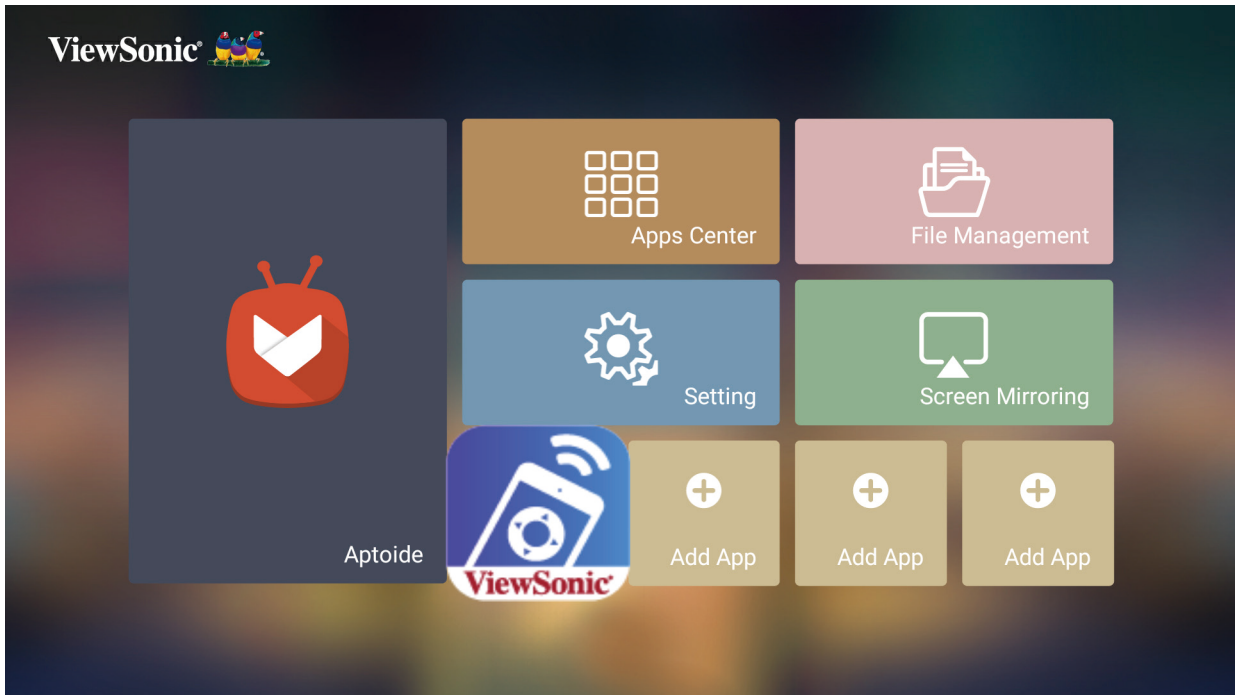

### Delete Apps From the Home Screen

1. From the **Home Screen**, select the App you want to delete and press and hold **OK** for three (3) seconds.
2. The message, “Do you want to Delete this application from My Favorites?” will appear.

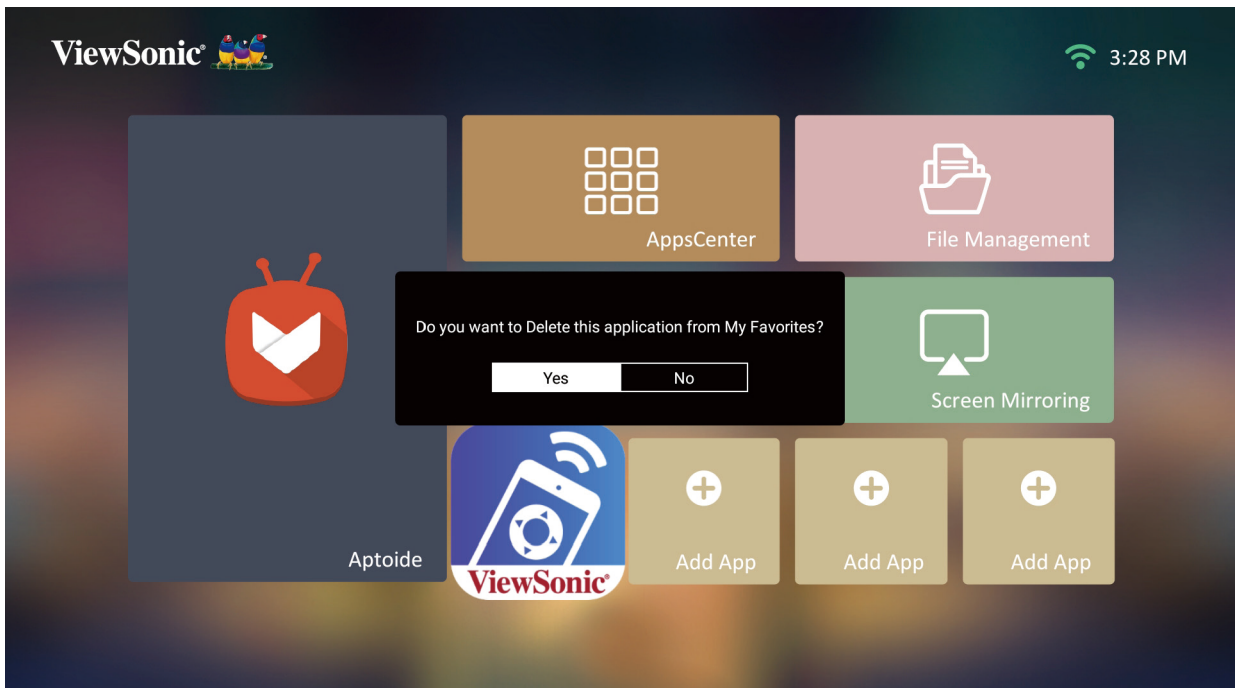

3. Select **Yes**, and press **OK** to delete the App.

# > Appendix

## Specifications

Item	Category	Specifications
Projector	Type	0.23" 1080p-Full HD, LED
	Display Size	30"~100"
	Throw Distance	0.65-2.68 m (80"±3%@2.14 m)
	Lens	F=1.7, f=6.35 mm
	Optical Zoom	Fixed
	Lamp Type	RGBB LED
	Light Source Life (Normal)	up to 30,000 hours
	Display Color	1.07 Billion Colors
	Keystone	Vertical: -/+ 40; Horizontal: -/+ 40
Input Signal	HDMI	f <sub>h</sub> : 30K~97KHz, f <sub>v</sub> :24~85Hz,
Resolution	Native	1920 x 1080
	Support	VGA (640 x 480) to Full HD (1920 x 1080)
Local Storage	Total	16 GB
	Available	10 GB
Input	HDMI	1 (HDMI 1.4, HDCP 1.4)
	SD Card	Micro SD (Supports up to 64 GB, SDXC)
	USB Type-C	1 (5V/2A)
	USB Type-A	1 USB 2.0 Reader
	Wi-Fi Input	1 (5G and 2.4G)
Output	Audio-Out (3.5 mm)	1
	Bluetooth Output	1 (BT 4.2/Audio Out)
	Speaker	3W Cube x 2
	USB Type A (Power)	1 (USB 2.0, 5V/2A, share with reader)
Power Adapter <sup>1</sup>	Input Voltage	DC IN 100-240V, 50/60 Hz (auto switch)
Operating Conditions	Temperature	0°C to 40°C (32°F to 104°F)
	Humidity	0% to 90% (non-condensing)
Dimensions	Physical (W x H x D)	184 x 184 x 54 mm (7.2" x 7.2" x 2.1")
Weight	Physical	1.0 kg (2.20 lbs)
Power Consumption	On	90W (Typical)
	Off	< 0.5W (Standby)

<sup>1</sup> Please use the power adapter from ViewSonic® or an authorized source only.

## Projector Dimensions

184 mm (W) x 184 mm (H) x 54 mm(D)

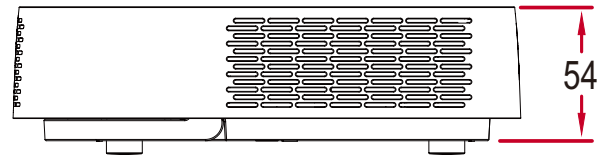
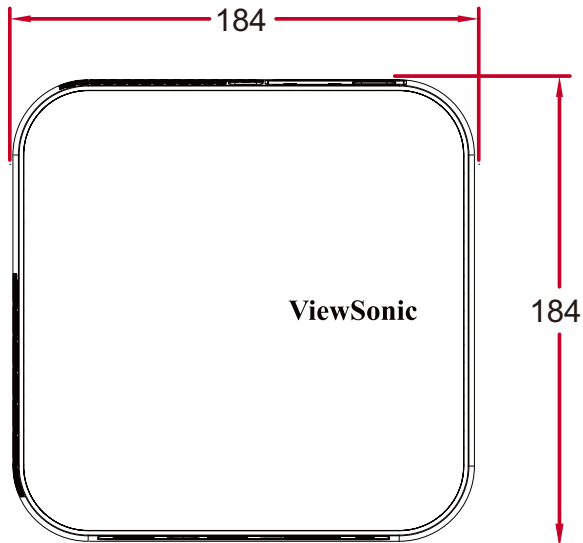

## Timing Chart

### HDMI Video Timing

Timing	Resolution	Horizontal Frequency (KHz)	Vertical Frequency (Hz)	Dot Clock Frequency (MHz)
<b>480i</b>	720(1440) x 480	15.73	59.94	27
<b>480p</b>	720 x 480	31.47	59.94	27
<b>576i</b>	720(1440) x 576	15.63	50	27
<b>576p</b>	720 x 576	31.25	50	27
<b>720/50p</b>	1280 x 720	37.5	50	74.25
<b>720/60p</b>	1280 x 720	45	60	74.25
<b>1080/50i</b>	1920 x 1080	28.13	50	74.25
<b>1080/60i</b>	1920 x 1080	33.75	60	74.25
<b>1080/24P</b>	1920 x 1080	27	24	74.25
<b>1080/50P</b>	1920 x 1080	56.25	50	148.5
<b>1080/60P</b>	1920 x 1080	67.5	60	148.5

## HDMI PC

Resolution	Refresh Rate (Hz)	Horizontal Frequency (KHz)	Dot Clock Frequency (MHz)
<b>640 x 480</b>	59.94	31.469	25.175
	72.809	37.861	31.5
	75	37.5	31.5
	85.008	43.269	36
<b>720 x 400</b>	70.087	31.469	28.3221
<b>800 x 600</b>	60.317	37.879	40
	72.188	48.077	50
	75	46.875	49.5
	85.061	53.674	56.25
	119.854	77.425	83
<b>1024 x 576</b>	60	35.82	46.966
<b>1024 x 600</b>	64.995	41.467	51.419
<b>1024 x 768</b>	60.004	48.363	65
	70.069	56.476	75
	75.029	60.023	78.75
	84.997	68.667	94.5
	119.989	97.441	115.5
<b>1152 x 864</b>	75	67.5	108
<b>1280 x 720</b>	60	45	74.25
<b>1280 x 768</b>	59.87	47.776	79.5
<b>1280 x 800</b>	59.81	49.702	83.5
	74.934	62.795	106.5
	84.88	71.554	122.5
<b>1280 x 960</b>	60	60	108
	85.002	85.938	148.5
<b>1280 x 1024</b>	60.02	63.981	108
	75.025	79.976	135
	85.024	91.146	157.5
<b>1360 x 768</b>	60.015	47.712	85.5
<b>1400 x 1050</b>	59.978	65.317	121.75
<b>1440 x 900</b>	59.887	55.935	106.5
<b>1600 x 1200</b>	60	75	162
<b>1680 x 1050</b>	59.954	65.29	146.25
<b>1920 x 1080 (VESA)</b>	60	67.5	148.5

<b>Resolution</b>	<b>Refresh Rate (Hz)</b>	<b>Horizontal Frequency (KHz)</b>	<b>Dot Clock Frequency (MHz)</b>
<b>640 x 480 @ 67Hz</b>	66.667	35	30.24
<b>832 x 624 @ 75Hz</b>	74.546	49.722	57.28
<b>1024 x 768 @ 75Hz</b>	75.02	60.241	80
<b>1152 x 870 @ 75Hz</b>	75.06	68.68	100

## USB C Timing

<b>Resolution</b>	<b>Refresh Rate (Hz)</b>	<b>Horizontal Frequency (KHz)</b>	<b>Dot Clock Frequency (MHz)</b>
<b>480i</b>	59.94	15.73	27
<b>480p</b>	59.94	31.47	27
<b>576i</b>	50	15.63	27
<b>576p</b>	50	31.25	27
<b>720/50p</b>	50	37.5	74.25
<b>720/60p</b>	60	45	74.25
<b>1080/50i</b>	50	28.13	74.25
<b>1080/60i</b>	60	33.75	74.25
<b>1080/24p</b>	24	27	74.25
<b>1080/50p</b>	50	56.25	148.5
<b>1080/60p</b>	60	67.5	148.5

# Troubleshooting

This section describes some common problems that you may experience when using the projector.

Problem or Issue	Possible Solutions
The projector does not turn on	<ul style="list-style-type: none"><li>• Ensure the power cord is properly attached to the projector and to the power outlet.</li><li>• If the cooling process has not completed, please wait until it has finished then try to turn on the projector again.</li><li>• If the above does not work, try another power outlet or another electrical device with the same power outlet.</li></ul>
There is no picture	<ul style="list-style-type: none"><li>• Ensure the video source cable is connected properly, and that the video source is turned on.</li><li>• If the input source is not selected automatically, select the correct source with the Source key on either the projector or the remote control.</li></ul>
The image is blurred	<ul style="list-style-type: none"><li>• Adjusting focus with the remote control will help correctly focus the projection lens.</li><li>• Ensure the projector and screen are aligned properly. If necessary, adjust the height of the projector as well as the projection angle and direction.</li></ul>
The remote control does not work	<ul style="list-style-type: none"><li>• Ensure there are no obstacles between the remote control and projector; and that they are within 8 m (26 ft) of each other.</li><li>• The batteries may be out of power, please check and replace if necessary.</li></ul>
The projector/system is frozen and will not respond	<ul style="list-style-type: none"><li>• Using a paper clip, carefully insert it into the <b>Reset</b> button at the rear of the projector to reset the device.</li></ul>

## LED Indicators

Light	Status and Description
	
	<b>Power</b>
Red	Stand-by mode (5 sec.) (< 0.5W)
Green	Power On



# Maintenance

## General Precautions

- Make sure the projector is turned off and the power cable is unplugged from the power outlet.
- Never remove any parts from the projector. Contact ViewSonic® or a reseller when any part of the projector needs replacing.
- Never spray or pour any liquid directly onto the case.
- Handle the projector with care, as a darker-colored projector, if scuffed, may show marks more clearly than a lighter-colored projector.

## Cleaning the Lens

- Use a canister of compressed air to remove dust.
- If the lens is still not clean, use lens-cleaning paper or moisten a soft cloth with lens cleaner and gently wipe the surface.

**CAUTION:** Never rub the lens with abrasive materials.

## Cleaning the Case

- Use a soft, lint-free, dry cloth to remove dirt or dust.
- If the case is still not clean, apply a small amount of non-ammonia, non-alcohol based, mild non-abrasive detergent onto a clean, soft, lint-free cloth, then wipe the surface.

**CAUTION:** Never use wax, alcohol, benzene, thinner, or other chemical detergents.

## Storing the Projector

If you intend to store the projector for an extended period of time:

- Ensure the temperature and humidity of the storage area are within the recommend range.
- Retract the adjuster foot completely.
- Remove the batteries from the remote control.
- Pack the projector in its original packaging or equivalent.

## Disclaimer

- ViewSonic® does not recommend the use of any ammonia or alcohol-based cleaners on the lens or case. Some chemical cleaners have been reported to damage the lens and/or case of the projector.
- ViewSonic® will not be liable for damage resulting from use of any ammonia or alcohol-based cleaners.

# > Regulatory and Service Information

## Compliance Information

This section addresses all connected requirements and statements regarding regulations. Confirmed corresponding applications shall refer to nameplate labels and relevant markings on the unit.

### FCC Compliance Statement

This device complies with part 15 of FCC Rules. Operation is subject to the following two conditions: (1) this device may not cause harmful interference, and (2) this device must accept any interference received, including interference that may cause undesired operation. This equipment has been tested and found to comply with the limits for a Class B digital device, pursuant to part 15 of the FCC Rules.

These limits are designed to provide reasonable protection against harmful interference in a residential installation. This equipment generates, uses, and can radiate radio frequency energy, and if not installed and used in accordance with the instructions, may cause harmful interference to radio communications. However, there is no guarantee that interference will not occur in a particular installation. If this equipment does cause harmful interference to radio or television reception, which can be determined by turning the equipment off and on, the user is encouraged to try to correct the interference by one or more of the following measures:

- Reorient or relocate the receiving antenna.
- Increase the separation between the equipment and receiver.
- Connect the equipment into an outlet on a circuit different from that to which the receiver is connected.
- Consult the dealer or an experienced radio/TV technician for help.

**Warning:** You are cautioned that changes or modifications not expressly approved by the party responsible for compliance could void your authority to operate the equipment.

### Industry Canada Statement

### FCC Radiation Exposure Statement

This equipment complies with FCC radiation exposure limits set forth for an uncontrolled environment. End users must follow the specific operating instructions for satisfying RF exposure compliance.

This transmitter must not be co-located or operating in conjunction with any other antenna or transmitter. This equipment should be installed and operated with a minimum distance of 20 centimeters between the radiator and your body.

The users manual or instruction manual for an intentional or unintentional radiator shall caution the user that changes or modifications not expressly approved by the party responsible for compliance could void the user's authority to operate the equipment.

### **IC Warning Statement**

This device complies with Industry Canada license- exempt RSS standard(s). Operation is subject to the following two conditions: (1) this device may not cause interference, and (2) this device must accept any interference, including interference that may cause undesired operation of the device.

Le présent appareil est conforme aux CNR d'Industrie Canada applicables aux appareils radio exempts de licence. L'exploitation est autorisée aux deux conditions suivantes : ( 1 ) l'appareil ne doit pas produire de brouillage, et ( 2 ) l'utilisateur de l'appareil doit accepter tout brouillage radioélectrique subi, même si le brouillage est susceptible d'en compromettre le fonctionnement.

### **Country Code Statement**

For product available in the USA/Canada market, only channel 1~11 can be operated. Selection of other channels is not possible.

Pour les produits disponibles aux États-Unis/Canada du marché, seul le canal 1 à 11 peuvent être exploités. Sélection d'autres canaux n'est pas possible.

### **IC Radiation Exposure Statement**

This equipment complied with IC RSS-102 radiation exposure limits set forth for an uncontrolled environment. This equipment should be installed and operated with minimum distance 20cm between the radiator & your body. The device for the band 5150-5825 MHz is only for indoor usage to reduce potential for harmful interference to co-channel mobile satellite systems.

Cet équipement est conforme aux limites d'exposition aux rayonnements IC établies pour un environnement non contrôlé. Cet équipement doit être installé et utilise avec un minimum de 20cm de distance entre la source de rayonnement et votre corps. les dispositifs fonctionnant dans la bande 5150-5825 MHz sont réservés uniquement pour une utilisation à l'intérieur afin de réduire les risques de brouillage

## CE Conformity for European Countries

**CE** The device complies with the EMC Directive 2014/30/EU, Low Voltage Directive 2014/35/EU, Ecodesign Directive 2009/125/EC and Radio Equipment Directive 2014/53/EU.

### The following information is only for EU-member states:

The mark shown to the right is in compliance with the Waste Electrical and Electronic Equipment Directive 2012/19/EU (WEEE). The mark indicates the requirement NOT to dispose of the equipment as unsorted municipal waste, but use the return and collection systems according to local law.



## Declaration of RoHS2 Compliance

This product has been designed and manufactured in compliance with Directive 2011/65/EU of the European Parliament and the Council on restriction of the use of certain hazardous substances in electrical and electronic equipment (RoHS2 Directive) and is deemed to comply with the maximum concentration values issued by the European Technical Adaptation Committee (TAC) as shown below:

Substance	Proposed Maximum Concentration	Actual Concentration
Lead (Pb)	0.1%	< 0.1%
Mercury (Hg)	0.1%	< 0.1%
Cadmium (Cd)	0.01%	< 0.01%
Hexavalent Chromium (Cr6 <sup>+</sup> )	0.1%	< 0.1%
Polybrominated biphenyls (PBB)	0.1%	< 0.1%
Polybrominated diphenyl ethers (PBDE)	0.1%	< 0.1%
Bis(2-Ethylhexyl) phthalate (DEHP)	0.1%	< 0.1%
Benzyl butyl phthalate (BBP)	0.1%	< 0.1%
Dibutyl phthalate (DBP)	0.1%	< 0.1%
Diisobutyl phthalate (DIBP)	0.1%	< 0.1%

**Certain components of products as stated above are exempted under the Annex III of the RoHS2 Directives as noted below. Examples of exempted components are:**

- Mercury in cold cathode fluorescent lamps and external electrode fluorescent lamps (CCFL and EEFL) for special purposes not exceeding (per lamp):
  - » Short length (500 mm): maximum 3.5 mg per lamp.
  - » Medium length (> 500 mm and 1,500 mm): maximum 5 mg per lamp.
  - » Long length (> 1,500 mm): maximum 13 mg per lamp.
- Lead in glass of cathode ray tubes.
- Lead in glass of fluorescent tubes not exceeding 0.2% by weight.
- Lead as an alloying element in aluminum containing up to 0.4% lead by weight.
- Copper alloy containing up to 4% lead by weight.
- Lead in high melting temperature type solders (i.e. lead-based alloys containing 85% by weight or more lead).
- Electrical and electronic components containing lead in a glass or ceramic other than dielectric ceramic in capacitors, e.g. piezoelectronic devices, or in a glass or ceramic matrix compound.

## **Indian Restriction of Hazardous Substances**

Restriction on Hazardous Substances statement (India). This product complies with the “India E-waste Rule 2011” and prohibits use of lead, mercury, hexavalent chromium, polybrominated biphenyls or polybrominated diphenyl ethers in concentrations exceeding 0.1 weight % and 0.01 weight % for cadmium, except for the exemptions set in Schedule 2 of the Rule.

## **Product Disposal at End of Product Life**

ViewSonic® respects the environment and is committed to working and living green. Thank you for being part of Smarter, Greener Computing. Please visit the ViewSonic® website to learn more.

### **USA & Canada:**

<http://www.viewsonic.com/company/green/recycle-program/>

### **Europe:**

<http://www.viewsoniceurope.com/eu/support/call-desk/>

### **Taiwan:**

<https://recycle.epa.gov.tw/>

## Copyright Information

Copyright© ViewSonic® Corporation, 2020 All rights reserved.

Macintosh and Power Macintosh are registered trademarks of Apple Inc.

Microsoft, Windows, and the Windows logo are registered trademarks of Microsoft Corporation in the United States and other countries.

ViewSonic®, the three birds logo, OnView, ViewMatch, and ViewMeter are registered trademarks of ViewSonic® Corporation.

VESA is a registered trademark of the Video Electronics Standards Association. DPMS, DisplayPort, and DDC are trademarks of VESA.

ENERGY STAR® is a registered trademark of the U.S. Environmental Protection Agency (EPA).

As an ENERGY STAR® partner, ViewSonic® Corporation has determined that this product meets the ENERGY STAR® guidelines for energy efficiency.

**Disclaimer:** ViewSonic® Corporation shall not be liable for technical or editorial errors or omissions contained herein; nor for incidental or consequential damages resulting from furnishing this material, or the performance or use of this product.

In the interest of continuing product improvement, ViewSonic® Corporation reserves the right to change product specifications without notice. Information in this document may change without notice.

No part of this document may be copied, reproduced, or transmitted by any means, for any purpose without prior written permission from ViewSonic® Corporation.

## Customer Service

For technical support or product service, see the table below or contact your reseller.

**NOTE:** You will need the product's serial number.

Country/ Region	Website	Country/ Region	Website
<b>Asia Pacific &amp; Africa</b>			
Australia	<a href="http://www.viewsonic.com/au/">www.viewsonic.com/au/</a>	Bangladesh	<a href="http://www.viewsonic.com/bd/">www.viewsonic.com/bd/</a>
中国 (China)	<a href="http://www.viewsonic.com.cn">www.viewsonic.com.cn</a>	香港 (繁體中文)	<a href="http://www.viewsonic.com/hk/">www.viewsonic.com/hk/</a>
Hong Kong (English)	<a href="http://www.viewsonic.com/hk-en/">www.viewsonic.com/hk-en/</a>	India	<a href="http://www.viewsonic.com/in/">www.viewsonic.com/in/</a>
Indonesia	<a href="http://www.viewsonic.com/id/">www.viewsonic.com/id/</a>	Israel	<a href="http://www.viewsonic.com/il/">www.viewsonic.com/il/</a>
日本 (Japan)	<a href="http://www.viewsonic.com/jp/">www.viewsonic.com/jp/</a>	Korea	<a href="http://www.viewsonic.com/kr/">www.viewsonic.com/kr/</a>
Malaysia	<a href="http://www.viewsonic.com/my/">www.viewsonic.com/my/</a>	Middle East	<a href="http://www.viewsonic.com/me/">www.viewsonic.com/me/</a>
Myanmar	<a href="http://www.viewsonic.com/mm/">www.viewsonic.com/mm/</a>	Nepal	<a href="http://www.viewsonic.com/np/">www.viewsonic.com/np/</a>
New Zealand	<a href="http://www.viewsonic.com/nz/">www.viewsonic.com/nz/</a>	Pakistan	<a href="http://www.viewsonic.com/pk/">www.viewsonic.com/pk/</a>
Philippines	<a href="http://www.viewsonic.com/ph/">www.viewsonic.com/ph/</a>	Singapore	<a href="http://www.viewsonic.com/sg/">www.viewsonic.com/sg/</a>
臺灣 (Taiwan)	<a href="http://www.viewsonic.com/tw/">www.viewsonic.com/tw/</a>	ประเทศไทย	<a href="http://www.viewsonic.com/th/">www.viewsonic.com/th/</a>
Việt Nam	<a href="http://www.viewsonic.com/vn/">www.viewsonic.com/vn/</a>	South Africa & Mauritius	<a href="http://www.viewsonic.com/za/">www.viewsonic.com/za/</a>
<b>Americas</b>			
United States	<a href="http://www.viewsonic.com/us">www.viewsonic.com/us</a>	Canada	<a href="http://www.viewsonic.com/us">www.viewsonic.com/us</a>
Latin America	<a href="http://www.viewsonic.com/la">www.viewsonic.com/la</a>		
<b>Europe</b>			
Europe	<a href="http://www.viewsonic.com/eu/">www.viewsonic.com/eu/</a>	France	<a href="http://www.viewsonic.com/fr/">www.viewsonic.com/fr/</a>
Deutschland	<a href="http://www.viewsonic.com/de/">www.viewsonic.com/de/</a>	Қазақстан	<a href="http://www.viewsonic.com/kz/">www.viewsonic.com/kz/</a>
Россия	<a href="http://www.viewsonic.com/ru/">www.viewsonic.com/ru/</a>	España	<a href="http://www.viewsonic.com/es/">www.viewsonic.com/es/</a>
Türkiye	<a href="http://www.viewsonic.com/tr/">www.viewsonic.com/tr/</a>	Україна	<a href="http://www.viewsonic.com/ua/">www.viewsonic.com/ua/</a>
United Kingdom	<a href="http://www.viewsonic.com/uk/">www.viewsonic.com/uk/</a>		



## **Limited Warranty**

### ViewSonic® Projector

#### **What the warranty covers:**

ViewSonic® warrants its products to be free from defects in material and workmanship, under normal use, during the warranty period. If a product proves to be defective in material or workmanship during the warranty period, ViewSonic® will, at its sole option, repair or replace the product with a like product. Replacement product or parts may include remanufactured or refurbished parts or components.

#### **Limited Three (3) year General Warranty:**

Subject to the more limited one (1) year warranty set out below, North and South America: Three (3) years warranty for all parts excluding the lamp, three (3) years for labor, and one (1) year for the original lamp from the date of the first consumer purchase.

Other regions or countries: Please check with your local dealer or local ViewSonic® office for the warranty information.

#### **Limited One (1) year Heavy Usage Warranty:**

Under heavy usage settings, where a projector's use includes more than fourteen (14) hours average daily usage, North and South America: One (1) year warranty for all parts excluding the lamp, one (1) year for labor, and ninety (90) days for the original lamp from the date of the first consumer purchase; Europe: One (1) year warranty for all parts excluding the lamp, one (1) year for labor, and ninety (90) days for the original lamp from the date of the first consumer purchase. Other regions or countries: Please check with your local dealer or local ViewSonic® office for the warranty information. Lamp warranty subject to terms and conditions, verification and approval. Applies to manufacturer's installed lamp only. All accessory lamps purchased separately are warranted for 90 days.

#### **Who the warranty protects:**

This warranty is valid only for the first consumer purchaser.

#### **What the warranty does not cover:**

1. Any product on which the serial number has been defaced, modified, or removed.
2. Damage, deterioration, or malfunction resulting from:

- » Accident, misuse, neglect, fire, water, lightning, or other acts of nature, unauthorized product modification, or failure to follow instructions supplied with the product.
- » Operation outside of product specifications.
- » Operation of the product for other than the normal intended use or not under normal conditions.
- » Repair or attempted repair by anyone not authorized by ViewSonic®.
- » Any damage of the product due to shipment.
- » Removal or installation of the product.
- » Causes external to the product, such as electric power fluctuations or failure.
- » Use of supplies or parts not meeting Viewsonic's specifications.
- » Normal wear and tear.
- » Any other cause which does not relate to a product defect.

### 3. Removal, installation, and set-up service charges.

#### **How to get service:**

1. For information about receiving service under warranty, contact ViewSonic® Customer Support (Please refer to the "Customer Support" page). You will need to provide your product's serial number.
2. To obtain warranted service, you will be required to provide: (a) the original dated sales slip, (b) your name, (c) your address, (d) a description of the problem, and (e) the serial number of the product.
3. Take or ship the product, freight prepaid, in the original container to an authorized ViewSonic® service center or ViewSonic®.
4. For additional information or the name of the nearest ViewSonic® service center, contact ViewSonic®.

#### **Limitation of implied warranties:**

There are no warranties, express or implied, which extend beyond the description contained herein including the implied warranty of merchantability and fitness for a particular purpose.

**Exclusion of damages:**

ViewSonic's liability is limited to the cost of repair or replacement of the product. ViewSonic® shall not be liable for:

1. Damage to other property caused by any defects in the product, damages based upon inconvenience, loss of use of the product, loss of time, loss of profits, loss of business opportunity, loss of goodwill, interference with business relationships, or other commercial loss, even if advised of the possibility of such damages.
2. Any other damages, whether incidental, consequential or otherwise.
3. Any claim against the customer by any other party.

**Effect of state law:**

This warranty gives you specific legal rights, and you may also have other rights which vary from local authority. Some local governments do not allow limitations on implied warranties and/or do not allow the exclusion of incidental or consequential damages, so the above limitations and exclusions may not apply to you.

**Sales outside the U.S.A. and Canada:**

For warranty information and service on ViewSonic® products sold outside of the U.S.A. and Canada, contact ViewSonic® or your local ViewSonic® dealer.

The warranty period for this product in mainland China (Hong Kong, Macao, and Taiwan Excluded) is subject to the terms and conditions of the Maintenance Guarantee Card.

For users in Europe and Russia, full details of warranty provided can be found at: <http://www.viewsonic.com/eu/> under "Support/Warranty Information".

# Mexico Limited Warranty

## ViewSonic® Projector

### What the warranty covers:

ViewSonic® warrants its products to be free from defects in material and workmanship, under normal use, during the warranty period. If a product proves to be defective in material or workmanship during the warranty period, ViewSonic® will, at its sole option, repair or replace the product with a like product. Replacement product or parts may include remanufactured or refurbished parts or components & accessories.

### How long the warranty is effective:

3 years for all parts excluding the lamp, 3 years for labor, 1 year for the original lamp from the date of the first consumer purchase.

Lamp warranty subject to terms and conditions, verification and approval. Applies to manufacturer's installed lamp only.

All accessory lamps purchased separately are warranted for 90 days.

### Who the warranty protects:

This warranty is valid only for the first consumer purchaser.

### What the warranty excludes and does not cover:

1. Any product on which the serial number has been defaced, modified or removed.
2. Damage, deterioration, or malfunction resulting from:
  - » Accident, misuse, neglect, fire, water, lightning, or other acts of nature, unauthorized product modification, unauthorized attempted repair, or failure to follow instructions supplied with the product.
  - » Any damage of the product due to shipment.
  - » Causes external to the product, such as electrical power fluctuations or failure.
  - » Use of supplies or parts not meeting ViewSonic®'s specifications.
  - » Normal wear and tear.
  - » Any other cause which does not relate to a product defect.
3. Any product exhibiting a condition commonly known as "image burn-in" which results when a static image is displayed on the product for an extended period of time.
4. Removal, installation, insurance, and set-up service charges.

**How to get service:**

For information about receiving service under warranty, contact ViewSonic® Customer Support (Please refer to the attached “Customer Service” page). You will need to provide your product’s serial number, so please record the product information in the space provided below on your purchase for your future use. Please retain your receipt of proof of purchase to support your warranty claim.

**For Your Records**

Product Name: \_\_\_\_\_ Model Number: \_\_\_\_\_

Document Number: \_\_\_\_\_ Serial Number: \_\_\_\_\_

Purchase Date: \_\_\_\_\_ Extended Warranty Purchase? \_\_\_\_\_ (Y/N)

If so, what date does warranty expire? \_\_\_\_\_

1. To obtain warranty service, you will be required to provide (a) the original dated sales slip, (b) your name, (c) your address, (d) a description of the problem, and (e) the serial number of the product.
2. Take or ship the product, in the original container packaging, to an authorized ViewSonic® service center.
3. Round trip transportation costs for in-warranty products will be paid by ViewSonic®.

**Limitation of implied warranties:**

There are no warranties, express or implied, which extend beyond the description contained herein including the implied warranty of merchantability and fitness for a particular purpose.

**Exclusion of damages:**

ViewSonic®’s liability is limited to the cost of repair or replacement of the product. ViewSonic® shall not be liable for:

1. Damage to other property caused by any defects in the product, damages based upon inconvenience, loss of use of the product, loss of time, loss of profits, loss of business opportunity, loss of goodwill, interference with business relationships, or other commercial loss, even if advised of the possibility of such damages.
2. Any other damages, whether incidental, consequential or otherwise.
3. Any claim against the customer by any other party.
4. Repair or attempted repair by anyone not authorized by ViewSonic®.

Contact Information for Sales & Authorized Service (Centro Autorizado de Servicio) within Mexico:	
<b>Name, address, of manufacturer and importers:</b> México, Av. de la Palma #8 Piso 2 Despacho 203, Corporativo Interpalmas, Col. San Fernando Huixquilucan, Estado de México Tel: (55) 3605-1099 <a href="http://www.viewsonic.com/la/soporte/index.htm">http://www.viewsonic.com/la/soporte/index.htm</a>	
NÚMERO GRATIS DE ASISTENCIA TÉCNICA PARA TODO MÉXICO: 001.866.823.2004	
<b>Hermosillo:</b> Distribuciones y Servicios Computacionales SA de CV. Calle Juárez 284 local 2 Col. Bugambilias C.P: 83140 Tel: 01-66-22-14-9005 E-Mail: <a href="mailto:disc2@hmo.megared.net.mx">disc2@hmo.megared.net.mx</a>	<b>Villahermosa:</b> Compumantenimientos Garantizados, S.A. de C.V. AV. GREGORIO MENDEZ #1504 COL, FLORIDA C.P. 86040 Tel: 01 (993) 3 52 00 47 / 3522074 / 3 52 20 09 E-Mail: <a href="mailto:compumantenimientos@prodigy.net.mx">compumantenimientos@prodigy.net.mx</a>
<b>Puebla, Pue. (Matriz):</b> RENTA Y DATOS, S.A. DE C.V. Domicilio: 29 SUR 721 COL. LA PAZ 72160 PUEBLA, PUE. Tel: 01(52).222.891.55.77 CON 10 LINEAS E-Mail: <a href="mailto:datos@puebla.megared.net.mx">datos@puebla.megared.net.mx</a>	<b>Veracruz, Ver.:</b> CONEXION Y DESARROLLO, S.A DE C.V. Av. Americas # 419 ENTRE PINZÓN Y ALVARADO Fracc. Reforma C.P. 91919 Tel: 01-22-91-00-31-67 E-Mail: <a href="mailto:gacosta@qplus.com.mx">gacosta@qplus.com.mx</a>
<b>Chihuahua:</b> Soluciones Globales en Computación C. Magisterio # 3321 Col. Magisterial Chihuahua, Chih. Tel: 4136954 E-Mail: <a href="mailto:Cefeo@soluglobales.com">Cefeo@soluglobales.com</a>	<b>Cuernavaca:</b> Compusupport de Cuernavaca SA de CV Francisco Leyva # 178 Col. Miguel Hidalgo C.P. 62040, Cuernavaca Morelos Tel: 01 777 3180579 / 01 777 3124014 E-Mail: <a href="mailto:aquevedo@compusupportcva.com">aquevedo@compusupportcva.com</a>
<b>Distrito Federal:</b> QPLUS, S.A. de C.V. Av. Coyoacán 931 Col. Del Valle 03100, México, D.F. Tel: 01(52)55-50-00-27-35 E-Mail : <a href="mailto:gacosta@qplus.com.mx">gacosta@qplus.com.mx</a>	<b>Guadalajara, Jal.:</b> SERVICRECE, S.A. de C.V. Av. Niños Héroes # 2281 Col. Arcos Sur, Sector Juárez 44170, Guadalajara, Jalisco Tel: 01(52)33-36-15-15-43 E-Mail: <a href="mailto:mmiranda@servicrece.com">mmiranda@servicrece.com</a>
<b>Guerrero Acapulco:</b> GS Computación (Grupo Sesicomp) Progreso #6-A, Colo Centro 39300 Acapulco, Guerrero Tel: 744-48-32627	<b>Monterrey:</b> Global Product Services Mar Caribe # 1987, Esquina con Golfo Pérsico Fracc. Bernardo Reyes, CP 64280 Monterrey N.L. México Tel: 8129-5103 E-Mail: <a href="mailto:aydeem@gps1.com.mx">aydeem@gps1.com.mx</a>
<b>MERIDA:</b> ELECTROSER Av Reforma No. 403Gx39 y 41 Mérida, Yucatán, México CP97000 Tel: (52) 999-925-1916 E-Mail: <a href="mailto:rrrb@sureste.com">rrrb@sureste.com</a>	<b>Oaxaca, Oax.:</b> CENTRO DE DISTRIBUCION Y SERVICIO, S.A. de C.V. Murguía # 708 P.A., Col. Centro, 68000, Oaxaca Tel: 01(52)95-15-15-22-22 Fax: 01(52)95-15-13-67-00 E-Mail: <a href="mailto:gpotai2001@hotmail.com">gpotai2001@hotmail.com</a>
<b>Tijuana:</b> STD Av Ferrocarril Sonora #3780 L-C Col 20 de Noviembre Tijuana, Mexico	<b>FOR USA SUPPORT:</b> ViewSonic® Corporation 381 Brea Canyon Road, Walnut, CA. 91789 USA Tel: 800-688-6688 E-Mail: <a href="http://www.viewsonic.com">http://www.viewsonic.com</a>



**ViewSonic®**  
*See the difference®*