

> XG320Q

Display User Guide

IMPORTANT: Please read this User Guide to obtain important information on installing and using your product in a safe manner, as well as registering your product for future service. Warranty information contained in this User Guide will describe your limited coverage from ViewSonic® Corporation, which is also found on our web site at <http://www.viewsonic.com> in English, or in specific languages using the Regional selection box in the upper right corner of our website. "Antes de operar su equipo lea cuidadosamente las instrucciones en este manual"

Model No. VS18553
P/N: XG320Q

Thank you for choosing ViewSonic®

As a world-leading provider of visual solutions, ViewSonic® is dedicated to exceeding the world's expectations for technological evolution, innovation, and simplicity. At ViewSonic®, we believe that our products have the potential to make a positive impact in the world, and we are confident that the ViewSonic® product you have chosen will serve you well.

Once again, thank you for choosing ViewSonic®!

> Safety Precautions

Please read these instructions completely before using the equipment.

- Keep these instructions in a safe place.
- Heed all warnings and follow all instructions.
- Sit at least 18" / 45 cm from the display.
- When installing the display, please leave 3.9" / 10 cm of open space around the display for ventilation safety purposes.
- Always handle the display with care when moving it.
- Always use cabinets or stands or installation methods recommended by the manufacturer of the display set.
- Always use furniture that can safely support the display.
- Always ensure the display is not overhanging the edge of the supporting furniture.
- Always educate children about the dangers of climbing on furniture to reach the display or related equipment.
- Always route and manage cords and cables connected to your display so they cannot be tripped over, pulled, or grabbed.
- Exercise caution when removing the rear cover of the display. This display contains high-voltage parts.
- Do not use this equipment near water. To reduce the risk of fire or electric shock, do not expose the display to rain or moisture.
- Avoid exposing the display to direct sunlight or other sources of sustained heat. Do not install near any heat sources such as radiators, heat registers, stoves, or other devices (including amplifiers) that may increase the temperature of the display to dangerous levels.
- Clean with a soft, dry cloth. If further cleaning is required, see the "Maintenance" section in this guide for further instructions.
- Avoid touching the screen. Skin oils are difficult to remove.
- Do not touch, rub, or apply pressure to the display screen, as it may permanently damage the screen.
- Do not place the display in an unstable location.
- Do not place the display on tall furniture (for example, cupboards or bookcases) without anchoring both the furniture and the display to a suitable support.
- Do not place the display on cloth or other materials that may be located between the product and supporting furniture.

- Place the display in a well-ventilated area. Do not place anything on the display that prevents heat dissipation.
- Do not place heavy objects on the display, video cable, or power cord.
- Do not place items that might tempt children to climb, such as toys and remote controls, on the top of the display or furniture on which the product is placed.
- If smoke appears, an abnormal noise, or a strange odor is present, immediately switch the display off and contact your dealer or ViewSonic. It is dangerous to continue using the display.
- Do not attempt to circumvent the safety provisions of the polarized or grounding-type plug. A polarized plug has two blades with one wider than the other. A grounding type plug has two blades and a third grounding prong. The wide blade and the third prong are provided for your safety. If the plug does not fit into your outlet, obtain an adaptor and do not attempt to force the plug into the outlet.
- Please confirm the distribution system installed in the building. The system should provide a circuit breaker rated at 120/240V, 20A.
- When connecting to a power outlet, DO NOT remove the grounding prong. Please ensure grounding prongs are NEVER REMOVED.
- Protect the power cord from being treaded upon or pinched, particularly at the plug, and at the point where it emerges from the equipment. Be sure that the power outlet is located near the equipment so that it is easily accessible.
- Only use attachments/accessories specified by the manufacturer.
- Use only with the cart, stand, tripod, bracket, or table specified by the manufacturer, or sold with the equipment. When a cart is used, use with caution when moving the cart/equipment combination to avoid injury from tipping over.
- Unplug this equipment when it will be unused for long periods of time.
- Refer all servicing to qualified service personnel. Service will be required when the unit has been damaged in any way, such as: if the power-supply cord or plug is damaged, if liquid is spilled onto or objects fall into the unit, if the unit is exposed to rain or moisture, or if the unit does not operate normally or has been dropped.
- Excessive sound volume from ear-/headphones may cause hearing damage/hearing loss.
- Adjustment of the volume control as well as the equalizer may increase the ear-/headphones output voltage and therefore, the sound volume level.
- The factors influencing the ear-/headphones output other than those specified by the manufacturer (e.g. operating system, equalizer software, firmware, driver) may increase the ear-/headphone output voltage and therefore, the sound volume level.

- **Stability Hazard:** The display may fall, causing serious personal injury or death. To prevent injury, this display must be securely attached to the floor/wall in accordance with the installation instructions.
- Fastening the display to a wall or fixed object using cordage or other restraining devices can help support the weight of the display in order to prevent the display from falling over.

Hole pattern (W x H)	Interface Pad (W x H x D)	Pad Hole	Screw Specification & Quantity
100 x 100 mm	115 x 115 x 2.6 mm	Ø 5 mm	M4 x 10 mm 4 pieces

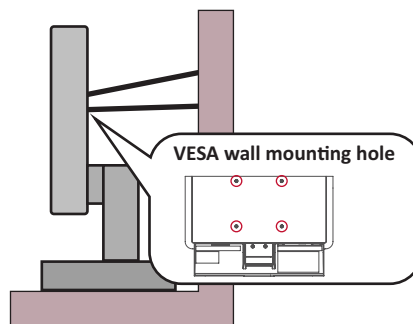

NOTE:

- Restraining device/cordage should be able to withstand 100N force.
- Make sure the cordage is straightened, and any slack is removed. The back of the device shall face the wall to ensure the device cannot tilt under external force.
- Make sure the display does not tilt under external force at any height and rotation angle of the device.
- If the existing display is going to be retained and relocated, the same considerations as above should be applied.

> Contents

Safety Precautions	3
Introduction	8
Package Contents	8
Product Overview	9
Initial Setup	10
Installing the Stand	10
Using the Mouse Anchor	13
Wall Mounting.....	14
Using the Security Slot.....	16
Making Connections	17
Connecting to Power	17
Connecting External Devices	18
HDMI Connection	18
DisplayPort Connection.....	19
USB Connection.....	20
Audio Connection.....	21
Using the Monitor	22
Adjusting the Viewing Angle.....	22
Height Adjustment	22
Tilt Angle Adjustment.....	23
Swivel Angle Adjustment.....	24
Turning the Device On/Off	25
Quick Access Menu	26
Using the Control Panel Keys.....	26
Hot Keys	27
Configuring the Settings	29
General Operations	29
On-Screen Display (OSD) Menu Tree	32
Menu Options	39

Advanced Features and Settings	50
Adaptive Sync	50
PureXP™	51
Hertz Limiter	52
Response Time OD.....	53
Blue Light Filter and Eye Health.....	54
Quick Access Blue Light Filter Setup.....	54
Calculating Breaks	55
Looking at Distant Objects	55
Eye and Neck Exercises	55
ViewScale.....	56
Quick Access	57
Elite RGB Lighting	58
Crosshair	59
Firmware Update.....	60
Appendix.....	62
Specifications.....	62
Glossary	64
Troubleshooting	69
Maintenance.....	71
General Precautions	71
Cleaning the Screen.....	71
Cleaning the Case	71
Regulatory and Service Information	72
Compliance Information.....	72
FCC Compliance Statement.....	72
Industry Canada Statement.....	72
Declaration of RoHS2 Compliance.....	73
Indian Restriction of Hazardous Substances	74
Product Disposal at End of Product Life	74
Copyright Information	75
Customer Service	76
Limited Warranty	77
Mexico Limited Warranty.....	80

> Introduction

Package Contents

- Monitor
- Power cord
- Video cable
- Quick start guide

NOTE: The power cord and video cables included in your package may vary depending on your country. Please contact your local reseller for more information.

Product Overview

Front View

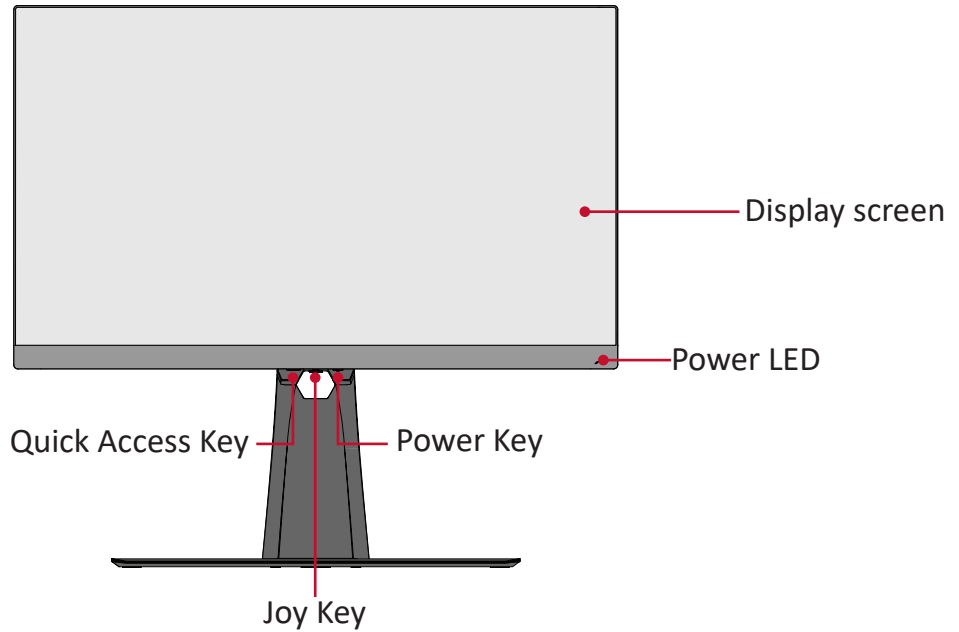

Rear View

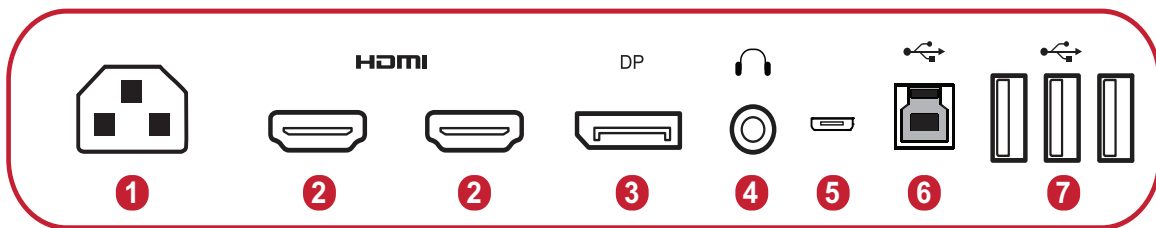
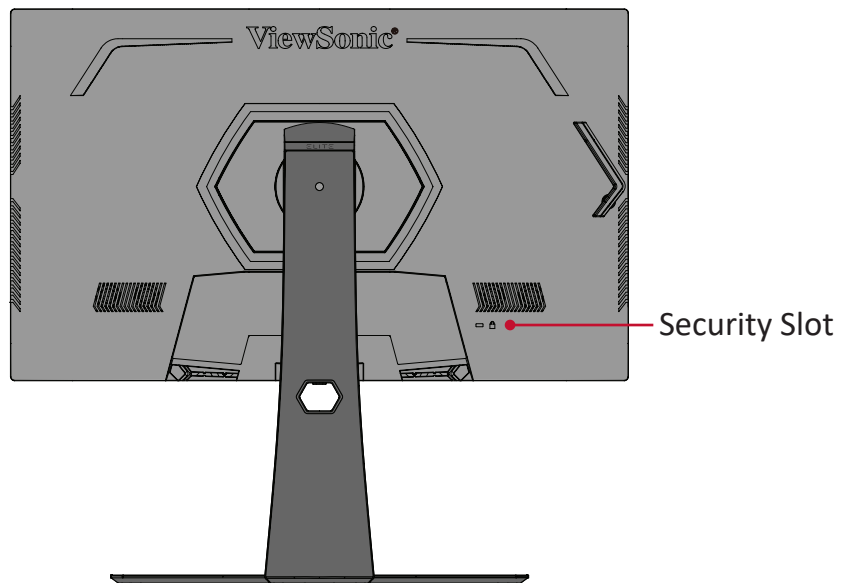

- 1. AC IN
- 2. HDMI
- 3. DisplayPort
- 4. Audio Out
- 5. Micro USB
- 6. USB Upstream
- 7. USB Downstream

NOTE: For more information about the [•] / [◀] / [▶] / [▲] / [▼] key and its functions, refer to “Hot Keys” on page 27.

> Initial Setup

This section provides detailed instructions for setting up your monitor.

Installing the Stand

1. Place the monitor on a flat, stable surface with the screen facing down.
2. Align and connect the two (2) points on the monitor stand's base with the monitor stand's neck.
3. Use the captured screw in the monitor stand's base and secure it to the monitor stand's neck.

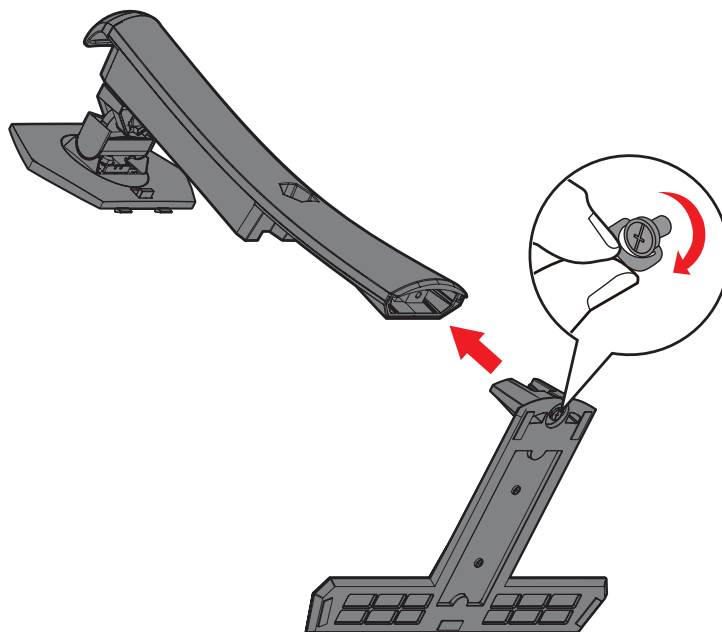

4. Align and slide the upper hooks of the monitor stand into the stand mounting slots as shown in the illustration below:

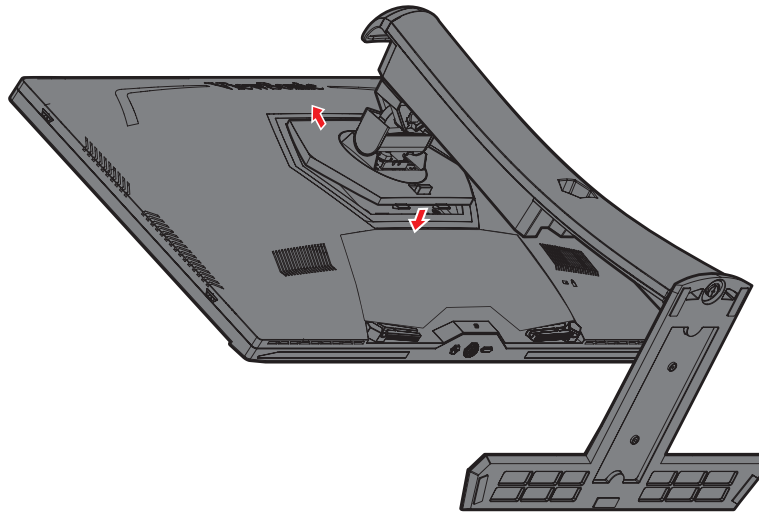

NOTE: Ensure the stand is secure and the quick release tab positively clicks into place.

5. Using the stand's handle, lift the device into its upright position on a flat, stable surface.

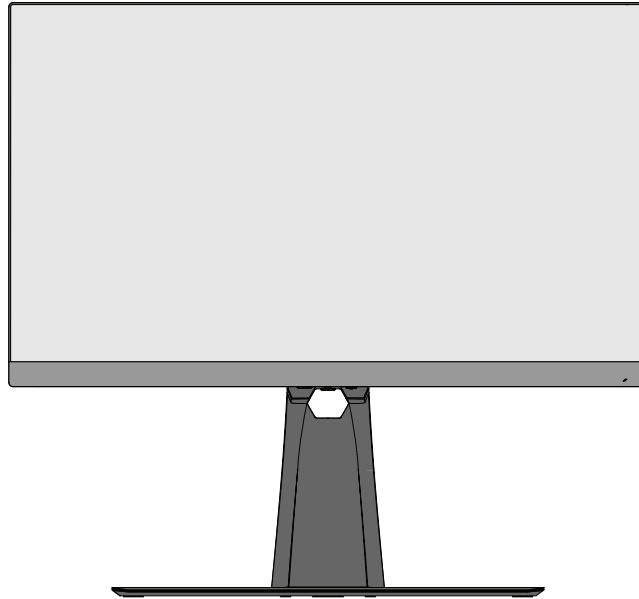

NOTE: Always place the device on a flat, stable surface. Failure to do so may cause the device to fall and damage the device and/or result in personal injury.

Using the Mouse Anchor

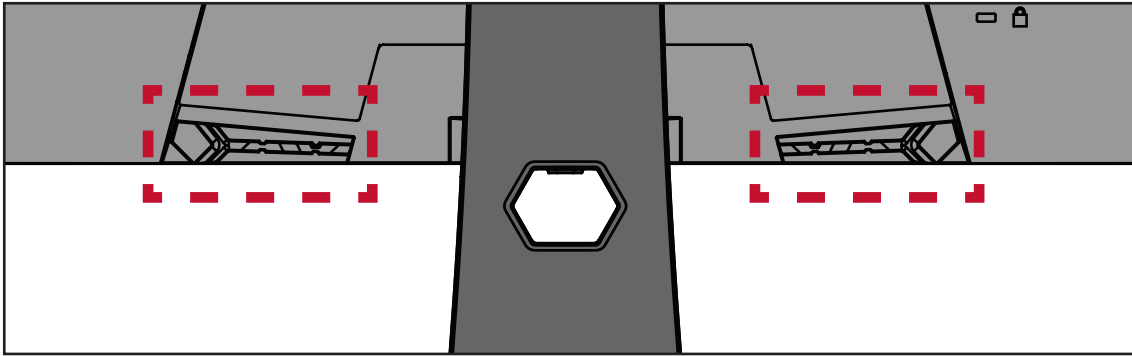

Included at the rear of the display, under the I/O ports, are two mouse anchors. Use these to prevent mouse cable dragging and personalize your mouse use setup.

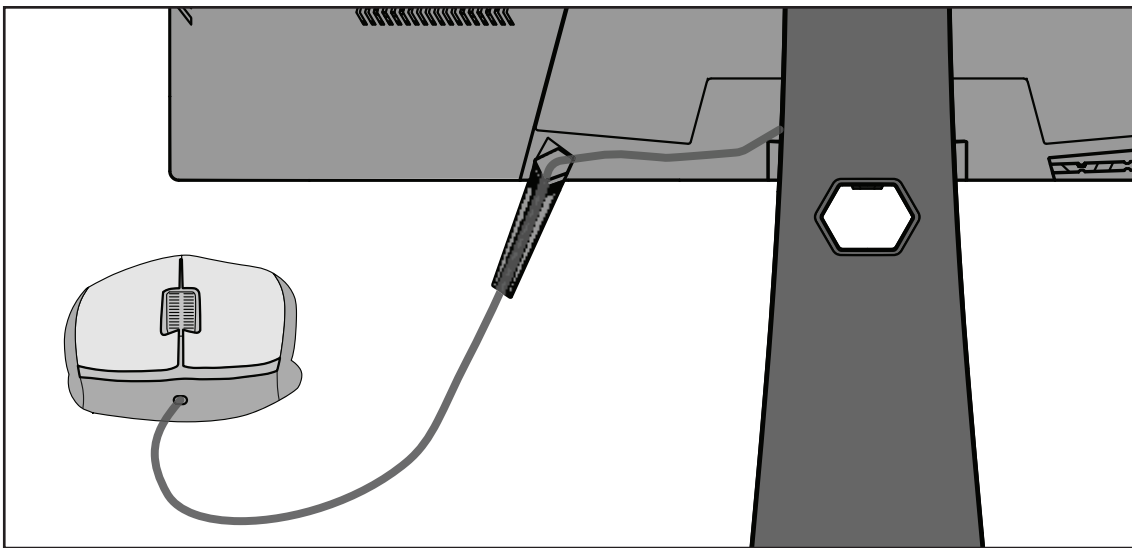

Wall Mounting

Refer to the table below for the standard dimensions for wall mount kits.

NOTE: For use only with a UL certified wall mount kit/bracket. To obtain a wall-mounting kit or height adjustment base, contact ViewSonic® or your local dealer.

Maximum Loading	Hole pattern (W x H)	Interface Pad (W x H x D)	Pad Hole	Screw Specification & Quantity
14 kg	100 x 100 mm	115 x 115 x 2.6 mm	Ø 5 mm	M4 x 10 mm 4 pieces

NOTE: Wall mount kits are sold separately.

1. Turn off the device and disconnect all cables.
2. Place the device on a flat, stable surface with the screen facing down.
3. Press and hold the quick release tab and carefully lift the stand.

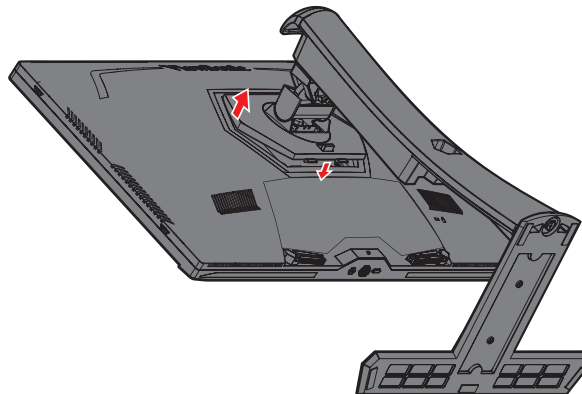

4. Pull down slightly to disengage the hooks and remove the stand.

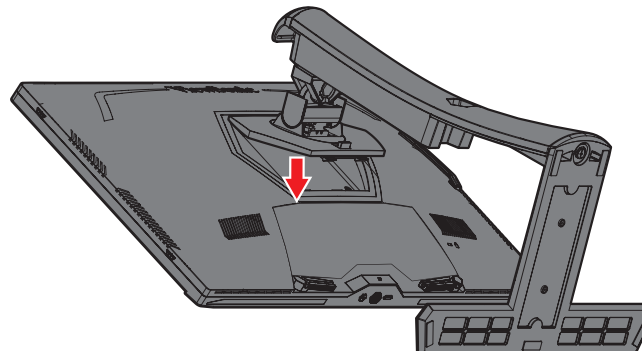

5. Attach the mounting bracket to the VESA mounting holes at the rear of the monitor. Then secure it with four (4) screws (M4 x 10 mm).

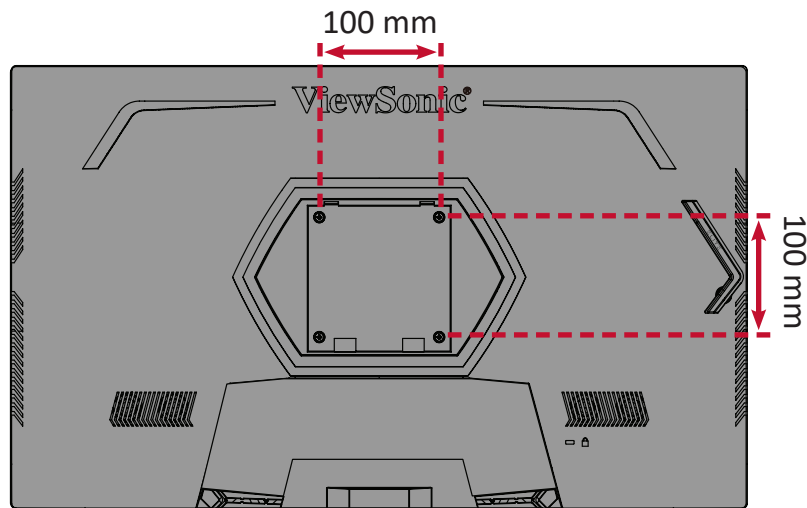

6. Follow the instructions that come with the wall mounting kit to mount the monitor onto the wall.

Using the Security Slot

To help prevent the device from being stolen, use a security slot locking device to secure the device to a fixed object.

Additionally, fastening the monitor to a wall or fixed object using a security cable can help support the weight of the monitor in order to prevent the monitor from falling over.

Below is an example of setting up a security slot locking device on a table.

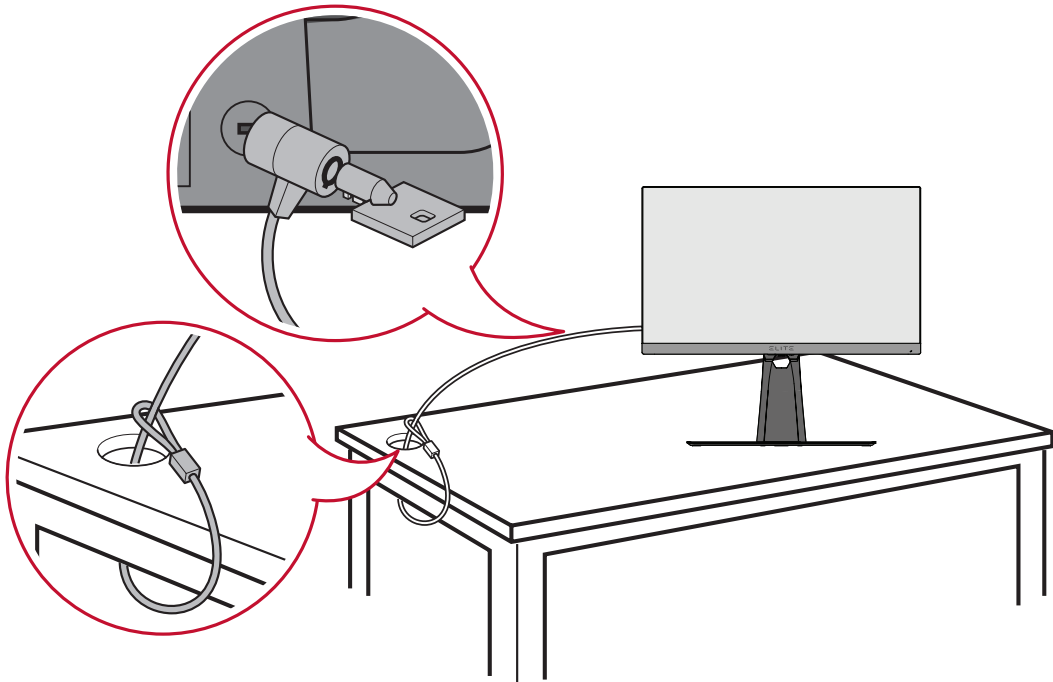

> Making Connections

This section guides you on how to connect the monitor with other equipment.

Connecting to Power

1. Connect the power cord to the AC IN jack at the rear of the device.
2. Connect the power cord plug to a power outlet.

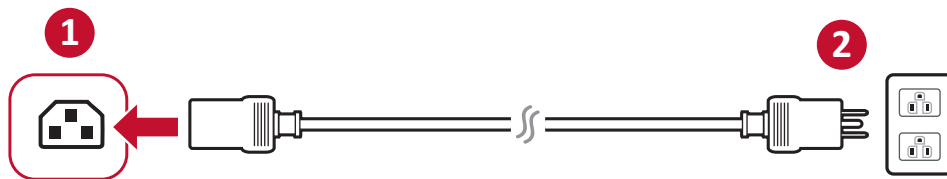
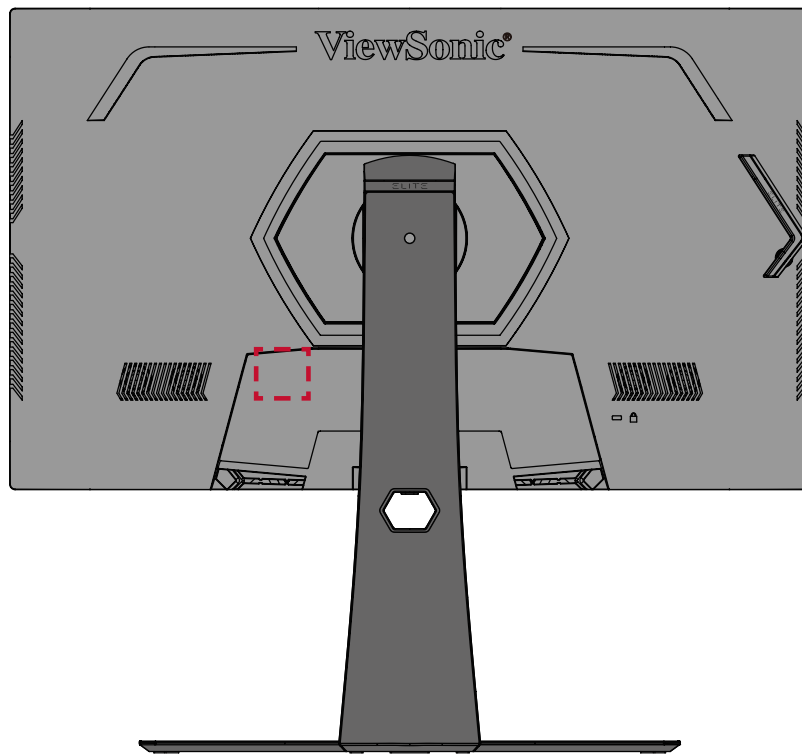

Connecting External Devices

HDMI Connection

Connect one end of an HDMI cable to the HDMI port of your monitor. Then connect the other end of the cable to the HDMI port of your computer.

NOTE: The monitor is equipped with two HDMI 2.0 ports.

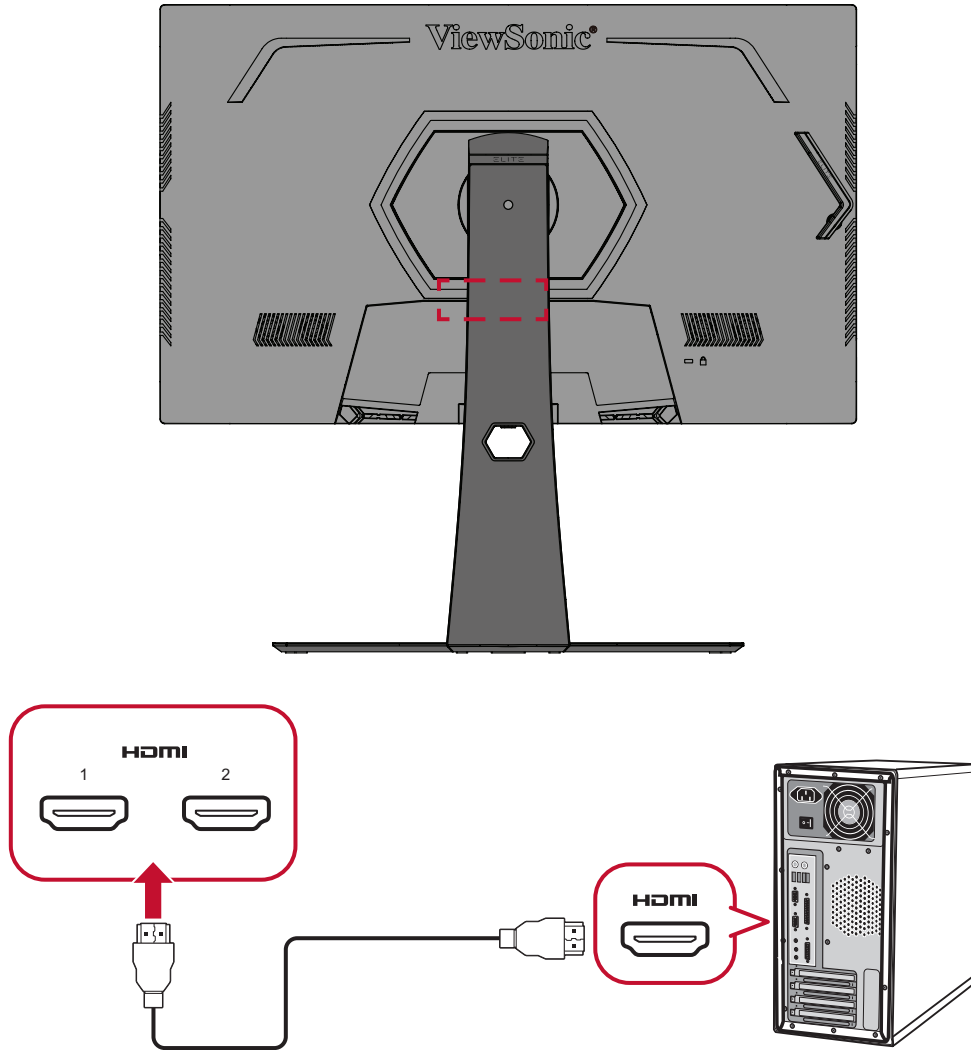

DisplayPort Connection

Connect one end of a DisplayPort cable to the DisplayPort port. Then connect the other end of the cable to the DisplayPort or mini DP port of your computer.

NOTE: To connect the monitor to the Thunderbolt port (v. 1&2) on your Mac, connect the mini DP end of the “mini DP to DisplayPort cable” to the Thunderbolt output of your Mac. Then connect the other end of the cable to the DisplayPort port of the monitor.

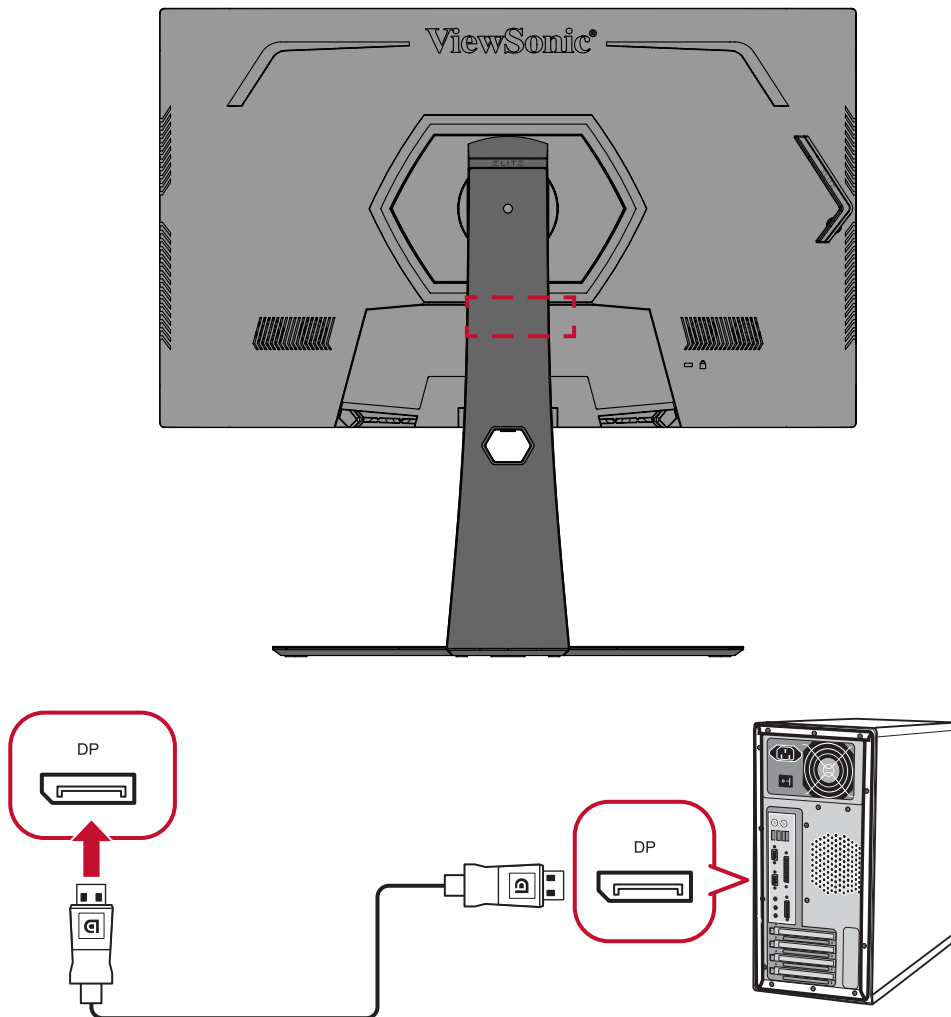

USB Connection

Connect one end of a USB cable to a USB port of the monitor. Then connect the other end of the cable to a USB port of your computer.

NOTE: The monitor supports three (3) types of USB ports. When making the connection(s), observe the following guidelines:

- Three (3) USB Type A ports: Connection for your Type A peripheral device(s) (i.e. storage device, keyboard, mouse).
 - » **NOTE:** To use some peripherals, please ensure your computer is also connected to the monitor's USB Type B port.
- One (1) USB Type B port: Connect the USB Type B male cable (square with 2 cut corners) to this port, and then connect the other end of the cable to the USB downstream port of your computer.
- One (1) Micro USB port: For Elite Ally use only.

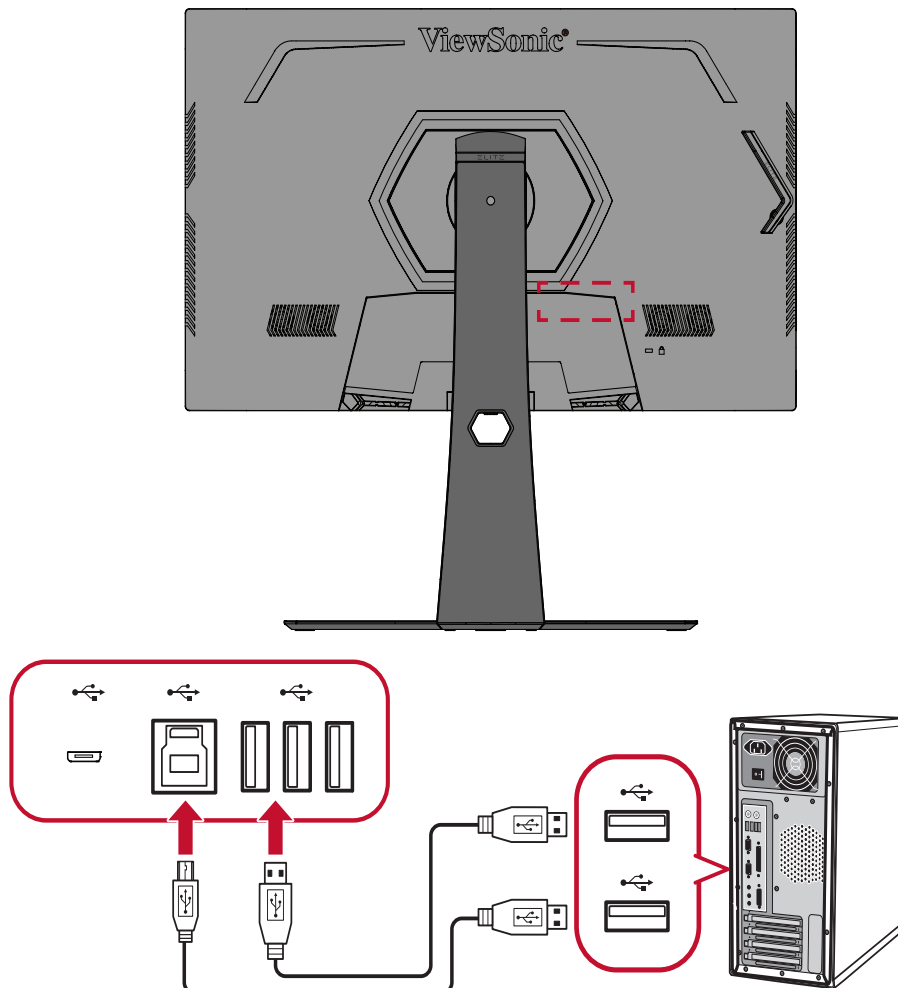

NOTE: The USB Type A port furthest to the right of the USB Type B port can support 5V 2.1A fast charging. The other two USB Type A ports can support 5V 0.9A charging.

Audio Connection

Plug the audio jack of the ear-/headphones into the Audio Out port of the monitor. Additionally, you can connect the monitor to a sound bar using an audio cable.

NOTE: The monitor is also equipped with dual speakers.

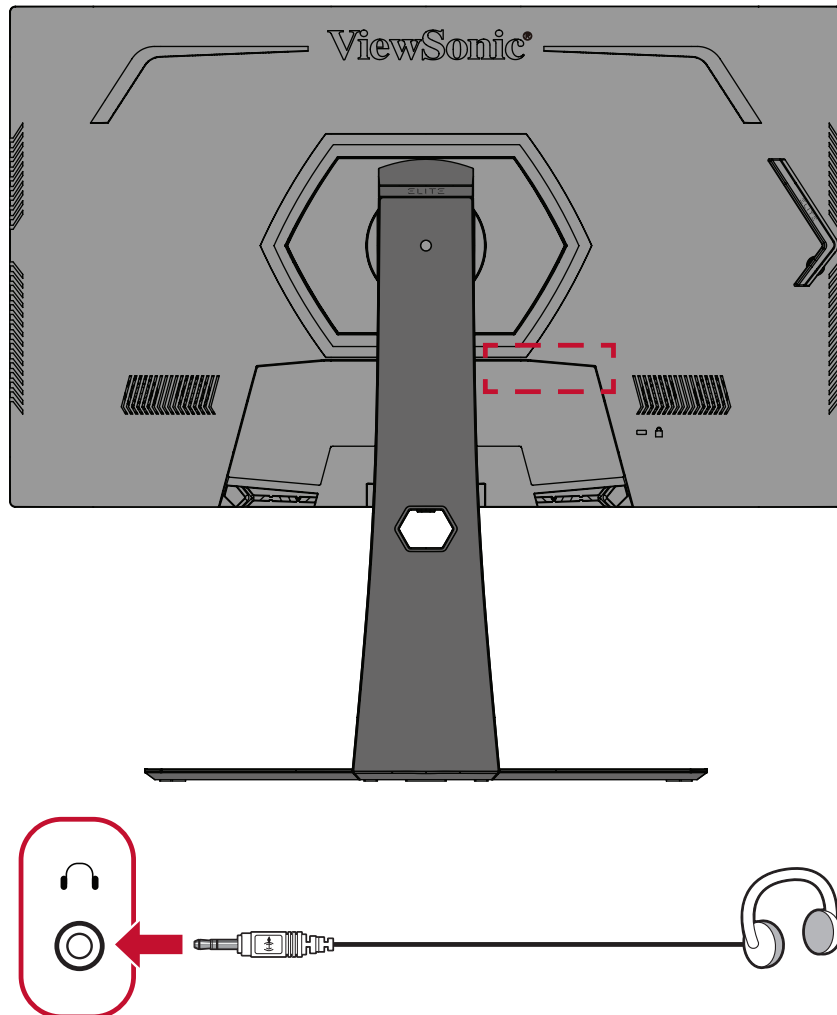

> Using the Monitor

Adjusting the Viewing Angle

For optimal viewing, you can adjust the viewing angle using any of the following methods:

Height Adjustment

Lower or raise the monitor to the desired height (0 to 120 mm).

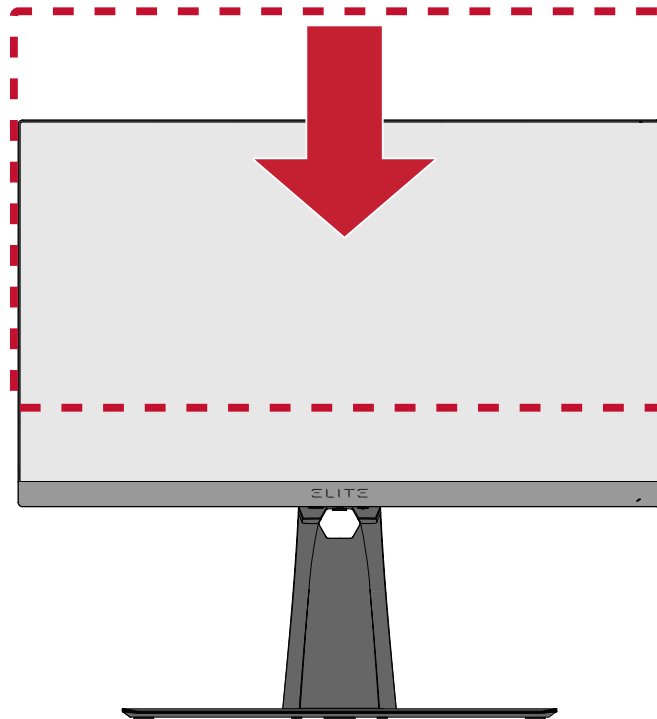

NOTE: When adjusting, press down firmly along the adjustment track holding the monitor with both hands on the side.

Tilt Angle Adjustment

Tilt the monitor forwards or backwards to the desired viewing angle (-5° to 20°).

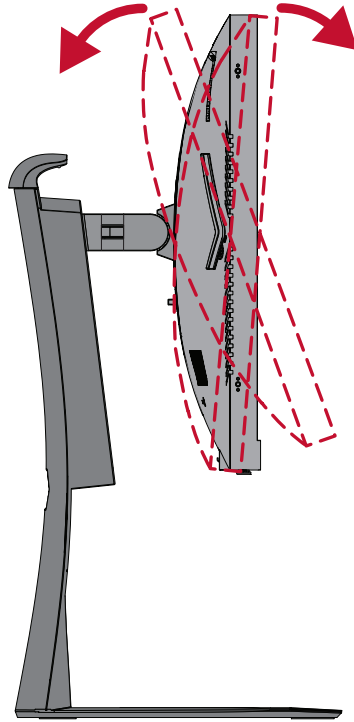

NOTE: When adjusting, support the stand firmly with one hand while tilting the monitor forwards or backwards with the other hand.

Swivel Angle Adjustment

Swivel the monitor to the left or right for the desired viewing angle (25°).

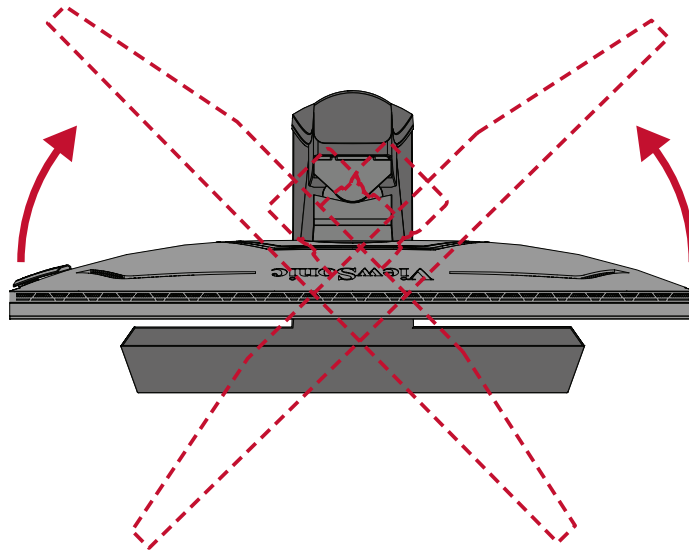

Turning the Device On/Off

1. Plug the connected power cord into a power outlet.
2. Press the **Power** button to turn on the monitor.
3. To turn the monitor off, press the **Power** button again.

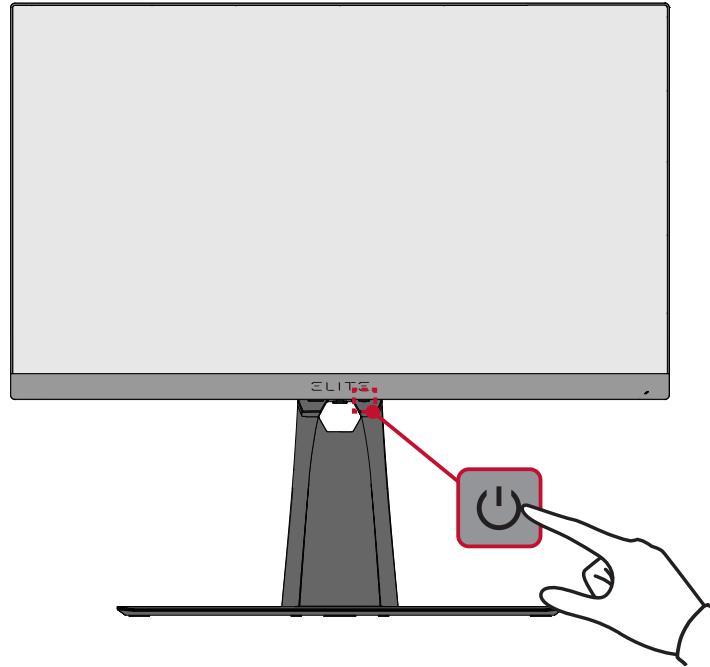

NOTE: The monitor will still consume some power as long as the power cord is connected to the power outlet. If the monitor is not being used for a long period of time, please disconnect the power plug from the power outlet.

Using the Control Panel Keys

Use the control panel keys to access the Quick Access Menu, navigate the On-Screen Display (OSD) Menu, and change the settings.

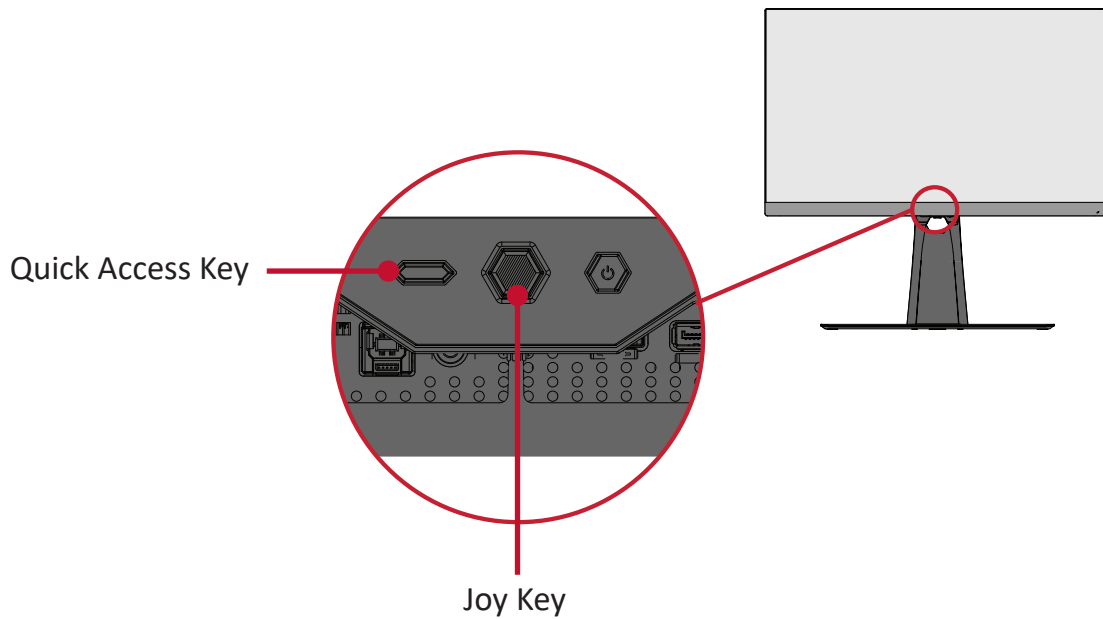

Quick Access Menu

Press the **Quick Access Key** to activate the **Quick Access Menu**. To learn more, see page 57.

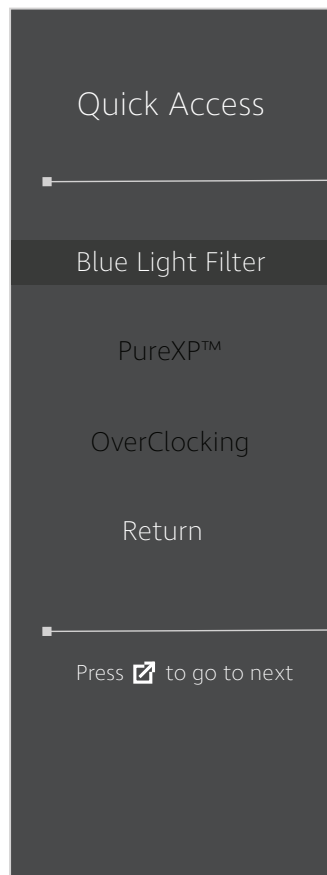

Hot Keys

When the On-Screen Display (OSD) Menu is off, you can quickly access special functions by using the control panel keys.

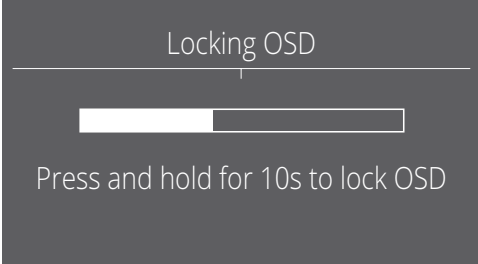
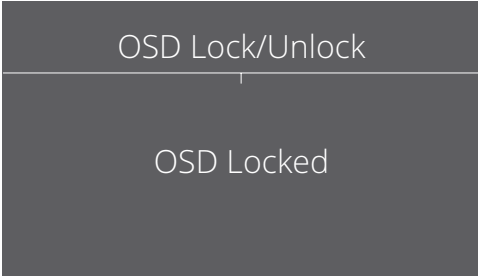
Key	Description
[◀]	<p>Press and hold the key for 5 seconds to lock/unlock the OSD Menu. When the menu appears on the screen, continue holding the key for 10 seconds to lock/unlock the OSD Menu.</p>  <p>The screenshot shows a dark grey OSD menu with the text 'Locking OSD' at the top. Below it is a horizontal progress bar with a white segment on the left and a grey segment on the right. At the bottom, it says 'Press and hold for 10s to lock OSD'.</p> <p>If the OSD Menu is locked, the below message will appear on the screen:</p>  <p>The screenshot shows a dark grey OSD menu with the text 'OSD Lock/Unlock' at the top and 'OSD Locked' in the center.</p>

Key	Description
<p>[▶]¹</p>	<p>Press and hold the key for 5 seconds to lock/unlock the Power button.</p> <p>When the menu appears on the screen, continue holding the key for 10 seconds to lock/unlock the Power button.</p> <div data-bbox="655 392 1142 656" data-label="Image"> </div> <p>If the Power button is locked, the below message will appear on the screen:</p> <div data-bbox="655 788 1142 1061" data-label="Image"> </div>
<p>[▲]</p>	<p>Press and hold the key for 5 seconds to display/hide the boot up screen when the device is turned on.</p> <div data-bbox="655 1191 1142 1464" data-label="Image"> </div>

¹ Only pressing this key will enable the **Input Select** function.

Configuring the Settings

General Operations

1. Press the [●] key or move the joy key [◀] or [▲] or [▼] to display the On-Screen Display (OSD) Menu.



2. Move the joy key [◀] or [▶] to select the main menu. Then move the joy key [▼] to enter the selected menu.



3. Move the joy key [▲] or [▼] to select the desired menu option. Then move the joy key [▶] to enter the sub-menu.



4. Move the joy key [▲] or [▼] to adjust/select the setting. Then press the [●] key to confirm.



NOTE: Certain menu option adjustments do not require the user to press the **[●]** key to confirm the selection.

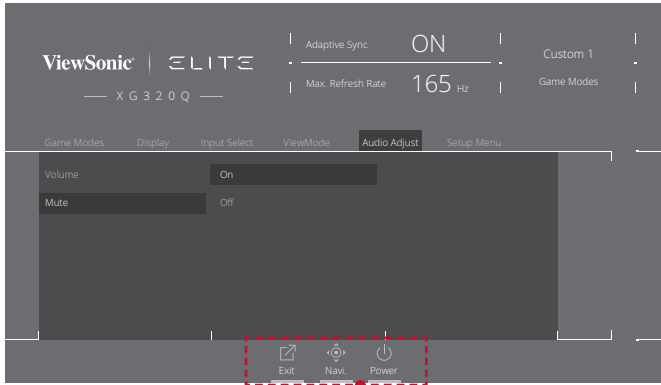

Key Guide



Key Guide

5. Press the **[←]** key to return to the previous menu.

NOTE: To exit the OSD Menu, press the **Quick Access** () key.

On-Screen Display (OSD) Menu Tree

Main Menu	Sub-menu	Menu Option	
Gaming Modes	Standard		
	Custom 1		
	Custom 2		
	FPS		
	MOBA		
	Battle Royale		
	Realistic		
	Vibrant		
	Console Speed		
	Console Color		
Display	Adaptive Sync	On	
		Off	
	HDR	Auto	
		Off	
	PureXP™	Light	
		Normal	
		Extreme	
		Ultra	
		Off	
	OverClocking	On	
		Off	
	Hertz Limiter	Native	
		60Hz	
		100Hz	
		144Hz	
		165Hz	
	Response Time OD	Standard	
		Fast	
		Faster	
		Ultra Fast	
		Fastest	
		Explanation (i)	
Blue Light Filter	(-/+ , 0~100)		

Main Menu	Sub-menu	Menu Option		
Display	Color Temperature	sRGB		
		Bluish		
		Cool		
		Native		
		Warm		
		Full Color Control	Red	(-/+ , 0~100)
	Green		(-/+ , 0~100)	
	Blue		(-/+ , 0~100)	
	Color Adjust	Color Space	Auto	
			RGB	
			YUV	
		Color Range	Auto	
			Full Range	
			Limited Range	
		Gamma	1.8	
			2.0	
			2.2	
			2.4	
			2.6	
			2.8	
	Color Saturation	(-/+ , 0~100)		
	Black Stabilization	(-/+ , 0~22)		
	Image Adjust	ViewScale	Full	
Aspect				
1:1				
19" (4:3)				
19"W (16:10)			(-/+ , 0~100)	
21.5" (16:9)			(-/+ , 0~100)	
22"W (16:10)				
23.6"W (16:9)				
24"W (16:9)				

Main Menu	Sub-menu	Menu Option	
Display	Image Adjust	Contrast	(-/+ , 0~100)
		Brightness	(-/+ , 0~100)
		Sharpness	(-/+ , 0~100)
		Advanced DCR	(-/+ , 0~20)
		Overscan	On
			Off
Input Select	HDMI 1		
	HDMI 2		
	DisplayPort		
ViewMode	Standard		
	Movie		
	Web		
	Text		
	MAC		
	Mono		
Audio Adjust	Volume		
	Mute	On	
		Off	

Main Menu	Sub-menu	Menu Option		
Setup Menu	Language	English		
		Français		
		Deutsch		
		Español		
		Italiano		
		Suomi		
		Русский		
		Türkçe		
		日本語		
		한국어		
		繁體中文		
		简体中文		
		Česká		
	Svenska			
	Information			
	Quick Access	Blue Light Filter	On/Off	
		PureXP™	On/Off	
		OverClocking	On/Off	
		FPS	On/Off	
		MOBA	On/Off	
Battle Royale		On/Off		
Realistic		On/Off		
Vibrant		On/Off		
Console Speed		On/Off		
Console Color		On/Off		
Custom 1		On/Off		
Custom 2		On/Off		

Main Menu	Sub-menu	Menu Option				
Setup Menu	Crosshair	Type A	Green	Preview Image		
			White			
			Yellow			
		Type B	Green	Preview Image		
			White			
			Yellow			
		Type C	Green	Preview Image		
			White			
			Yellow			
			Off			
		Elite RGB	Rear	Rainbow		
				Breathing		
				Stack		
	Others					
	Off					
	Base		Rainbow			
			Breathing			
			Stack			
			Others			
			Off			
	Always On		On			
			Off			
			Reset			
			Off			
	Resolution Notice		On			
			Off			
	Boot Up Screen		On			
Off						
OSD Timeout	5/15/30/60					
OSD Background	On					
	Off					

Main Menu	Sub-menu	Menu Option		
Setup Menu	Multi-Picture	Off		
		PBP Left-Right	Left Source Select	HDMI 1
				HDMI 2
				DisplayPort
		PBP Left-Right	Right Source Select	HDMI 1
				HDMI 2
				DisplayPort
		PBP Left-Right	Swap	
		PIP	PIP Source Select	HDMI 1
				HDMI 2
				DisplayPort
			PIP H. Position	(-/+ , 0~100)
			PIP V. Position	(-/+ , 0~100)
			PIP Size	(-/+ , 0~100)
			PIP Swap	
	Power Indicator	On		
		Off		
	Auto Power Off	On		
		Off		
	Sleep	30 Minutes		
		45 Minutes		
		60 Minutes		
		120 Minutes		
		Off		
	ECO Mode	Standard		
		Optimize		
		Conserve		
		Energy Saving	On	
	Off			

Main Menu	Sub-menu	Menu Option	
Setup Menu	DDC/CI	On	
		Off	
	DisplayPort 1.2	On	
		Off	
	Standby Charger	On	
		Off	
	Rename		
	Memory Recall		

Menu Options

Game Modes

1. Press the [●] key or move the joy key [◀] or [▲] or [▼] to display the On-Screen Display (OSD) Menu.
2. Move the joy key [◀] or [▶] to select **Game Modes**. Then move the joy key [▼] to enter the **Game Modes** menu.



3. Move the joy key [▲] or [▼] to select the setting. Then press the [●] key to confirm the selection.

Menu Option	Description
Standard	Select this option for general use.
Custom 1/2	Two customizable “Custom” settings are available to help match individual preferences and adapt to every type of game on the market.
FPS	Ideal for First-Person Shooter games.
MOBA	Select this option for Multiplayer Online Battle Arena games.
Battle Royale	Tuned for Battle Royale games.
Realistic	True-to-life color representation.
Vibrant	Lush and saturated colors.
Console Speed	Speed focused for console use.
Console Color	Color accuracy focus for console use.

Display

1. Press the [●] key or move the joy key [◀] or [▲] or [▼] to display the On-Screen Display (OSD) Menu.
2. Move the joy key [◀] or [▶] to select **Display**. Then move the joy key [▼] to enter the **Display** menu.

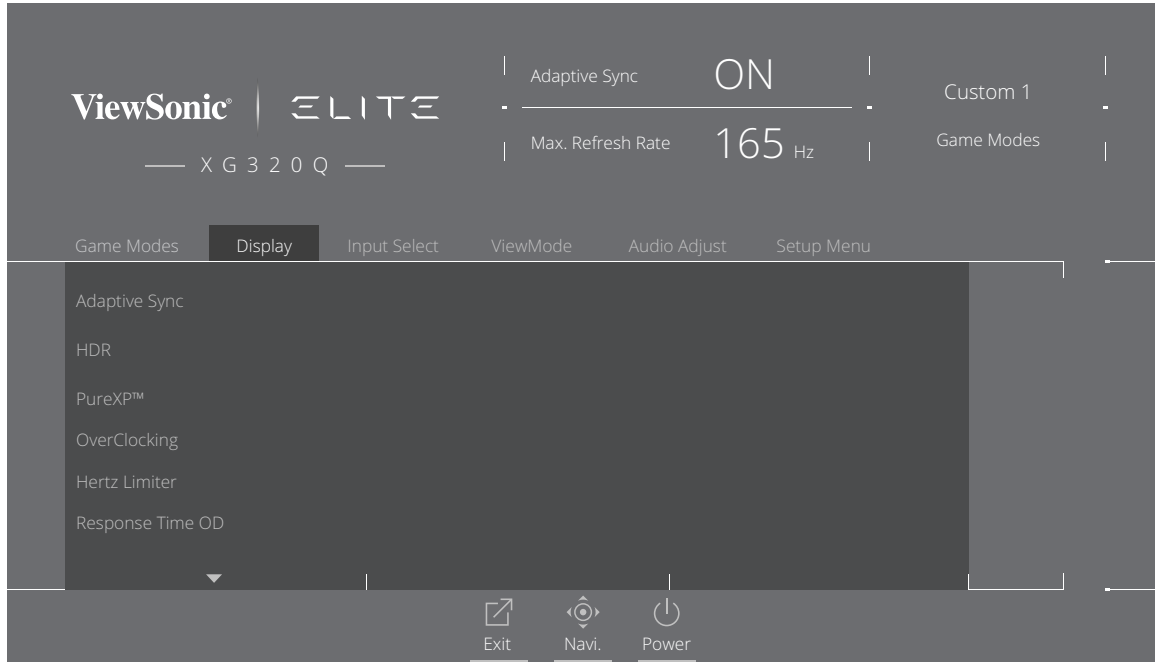

3. Move the joy key [▲] or [▼] to select the menu option. Then move the joy key [▶] to enter its sub-menu.
4. Move the joy key [▲] or [▼] to adjust/select the setting. Then press the [●] key to confirm (if applicable).

NOTE: Some sub-menu options may have another sub-menu. To enter the respective sub-menu, move the joy key [▶].

Menu Option	Description
Adaptive Sync	Eliminates stuttering and tearing during gameplay.
HDR	Reduce the overall contrast of a given scene so that detail in the highlights and shadows can be seen.
PureXP™	Short for “Pure Experience”, this feature can enhance the visual quality of moving objects, making them less vague with a clearer view. NOTE: Only available for refresh rates above 100Hz.
OverClocking	When “On” go beyond the monitor’s 175Hz refresh rate. NOTE: Overclocking ability is dependent on the graphics card.

Menu Option	Description
Hertz Limiter	Allows users to control how many frames the monitor can output.
Response Time OD	An advanced tuning function for users that want to adjust their monitor's response time.
Blue Light Filter	Adjustable filter, available in all Game Modes , that blocks high-energy blue light for a more comfortable viewing experience. For more information, see page 54.
Color Temperature	Select the color temperature setting. <ul style="list-style-type: none"> • sRGB: Lower brightness and more natural colors. • Bluish: Set the color temperature to 9300K. • Cool: Set the color temperature to 7500K. • Native: Default color temperature. Recommended for regular use. • Warm: Set the color temperature to 5000K. • Full Color Control: Adjust red, green, and blue values as desired.

Menu Option	Description
Color Adjust	<p><u>Color Space</u></p> <p>Allows users to choose which color space they would like to use for color output.</p> <ul style="list-style-type: none"> • Auto: Automatically recognizes the color format and black and white levels. • RGB: The input signal color is RGB. • YUV: The input signal color is YUV. <p><u>Color Range</u></p> <p>The monitor can detect the input signal color range automatically. You can manually change the color range options to fit the correct color range if the colors are not displayed correctly.</p> <ul style="list-style-type: none"> • Auto: Automatically recognizes the color format and black and white levels. • Full Range: Black and white levels are full. • Limited Range: Black and white levels are limited. <p><u>Gamma</u></p> <p>Allows users to manually adjust the brightness level of the monitor's grayscale levels.</p> <p><u>Color Saturation</u></p> <p>Adjusts the color depth of each color (red, green, blue, cyan, magenta, and yellow).</p> <p><u>Black Stabilization</u></p> <p>Provides heightened visibility and detail by brightening dark scenes.</p>

Menu Option	Description
Image Adjust	<p><u>ViewScale</u> Users have the ability to adjust the display size of the image on the monitor, allowing for a “best fit” scenario.</p> <p><u>Contrast</u> Adjusts the difference between the image background (black level) and the foreground (white level).</p> <p><u>Brightness</u> Adjusts background black levels of the screen image.</p> <p><u>Sharpness</u> Adjusts the picture quality of the monitor.</p> <p><u>Advanced DCR</u> Automatically detects the image signal and intelligently controls the backlight brightness and color to improve on the ability to make the black blacker in a dark scene, and make the white whiter in a bright environment.</p> <p><u>Overscan</u> Refers to a cropped image on your monitor’s screen. A setting on your monitor zooms in on movie content, so that you cannot see the outermost edges of the film.</p>

Input Select

1. Press the [●] key or move the joy key [◀] or [▲] or [▼] to display the On-Screen Display (OSD) Menu.
2. Move the joy key [◀] or [▶] to select **Input Select**. Then move the joy key [▼] to enter the **Input Select** menu.



3. Move the joy key [▲] or [▼] to select the desired input source. Then press the [●] key to confirm the selection.

ViewMode

NOTE: ViewMode is only accessible when using **Custom 1** or **2 Game Modes**.

1. Press the [●] key or move the joy key [◀] or [▲] or [▼] to display the On-Screen Display (OSD) Menu.
2. Move the joy key [◀] or [▶] to select **ViewMode**. Then move the joy key [▼] to enter the **ViewMode** menu.

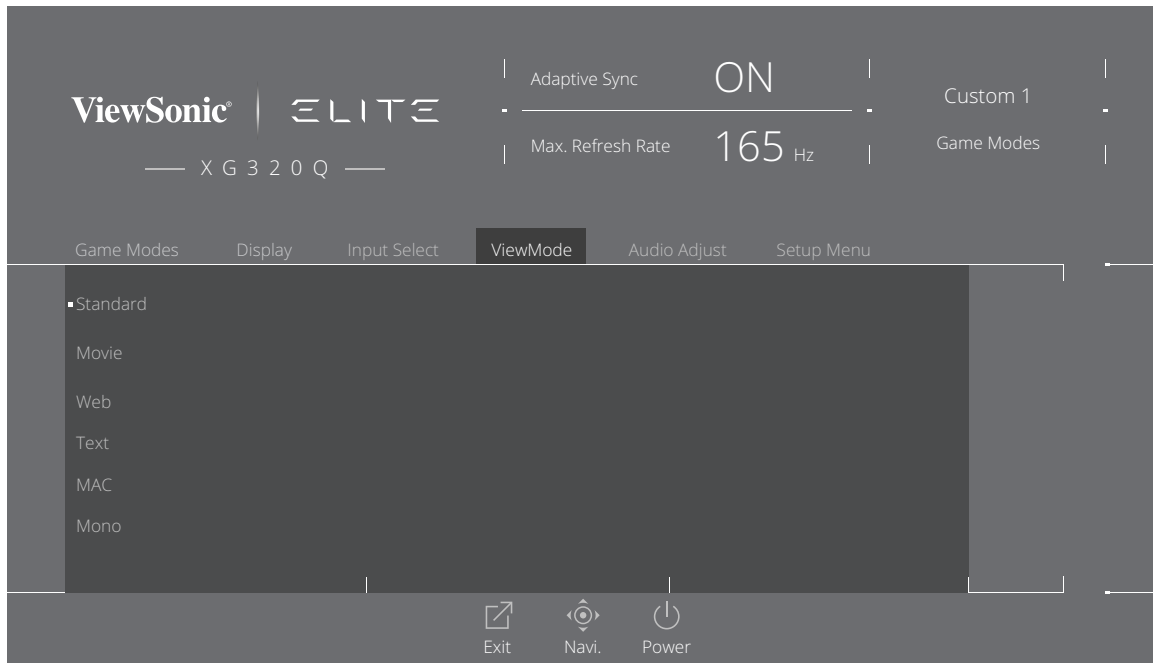

3. Move the joy key [▲] or [▼] to select the setting. Then press the [●] key to confirm the selection.

Menu Option	Description
Standard	Select this option for general use.
Movie	Select this option for watching movies.
Web	Select this option for surfing the web.
Text	Select this option for text-based tasks.
MAC	Select this option when connecting to Mac computers.
Mono	Select this option for monochrome.

Audio Adjust

1. Press the [●] key or move the joy key [◀] or [▲] or [▼] to display the On-Screen Display (OSD) Menu.
2. Move the joy key [◀] or [▶] to select **Audio Adjust**. Then move the joy key [▼] to enter the **Audio Adjust** menu.



3. Move the joy key [▲] or [▼] to select the desired option. Then move the joy key [▶] to enter its sub-menu.
4. Move the joy key [▲] or [▼] to adjust/select the setting, and press the [●] key to confirm the selection (if applicable).

Menu Option	Description
Volume	Adjust the volume level.
Mute	Enable to disable the sound.

Setup Menu

1. Press the [●] key or move the joy key [◀] or [▲] or [▼] to display the On-Screen Display (OSD) Menu.
2. Move the joy key [◀] or [▶] to select **Setup Menu**. Then move the joy key [▼] to enter the **Setup Menu** menu.



3. Move the joy key [▲] or [▼] to select the menu option. Then move the joy key [▶] to enter its sub-menu.
4. Move the joy key [▲] or [▼] to adjust/select the setting. Then press the [●] key to confirm (if applicable).

NOTE: Some sub-menu options may have another sub-menu. To enter the respective sub-menu, move the joy key [▶].

Menu Option	Description
Language Select	Select an available language for the OSD Menu.
Information	Display the monitor information.
Quick Access	Select which options to have present in the Quick Access Menu.
Crosshair	Aim more clearly and quickly during FPS games with the on-screen overlay. For more, see page 59.
Elite RGB	<p>This setting controls the RGB lighting on the back of the monitor and under the bezel in order to enhance your RGB experience. When switched on, or after being reset, the default 'Breathing' will activate.</p> <p>In addition, the RGB lights are also synced with several key partners. Downloading their software will give you the power to manipulate your RGB capabilities even further.</p> <p>If you would like to leverage partnered software see the advanced setup below.</p> <p><u>Partner Software RGB Setup</u></p> <ul style="list-style-type: none"> • Visit https://www.viewsonic.com/elite/rgb/ and choose a partner RGB software to download. • Download and install your software of choice. • Included with your monitor is a USB 3.0 A-Male to B-Male cable. Plug in the USB 3.0 B-Male connector to your monitor and the USB 3.0 A-Male connector to your PC. • Run the partner software and start customizing your RGB lighting! <p>You can also check out our RGB software setup tutorials online at https://www.viewsonic.com/elite/rgb/.</p> <p>*Mode variations, customization features and any other features or uses shall be based on and subject to the terms of use, end user license agreement and the software capabilities as specified or provided in partners' software.</p>
Resolution Notice	Enable this option to allow the system to inform users that the current viewing resolution is not the correct native resolution.
Boot Up Screen	Toggle the start screen On or Off.

Menu Option	Description
OSD Timeout	Adjust the length of time the OSD Menu remains on screen.
OSD Background	Show/Hide the OSD background when the OSD Menu appears on the screen.
Multi-Picture	<p><u>Off</u> Disable this function.</p> <p><u>PBP Left-Right</u> Display two windows, a 1x1 split screen, side-by-side on the left and right of the screen. The user can specify the input source for each screen.</p> <p><u>PIP</u> Split the screen into two parts, a main window and an inset window. The user can specify the input source for each screen.</p>
Power Indicator	Set the Power Indicator On or Off. If the setting is set to On, the power indicator lights blue when the device is turned on.
Auto Power Off	Enable this option to allow the monitor to automatically turn off after a certain amount of time.
Sleep	Set the amount of idle time before the monitor enters <i>Sleep mode</i> .
ECO Mode	Choose between various modes, based on power consumption. NOTE: Energy Saving Mode is On by default. Once turned Off, the brightness level can be adjusted to the maximum level.
DDC/CI	Enable this option to allow the monitor control via the graphics card.
DisplayPort 1.2	Enable/Disable DisplayPort 1.2 support.
Standby Charger	When activated, the USB will continue to supply power even when the monitor is in standby mode.
Rename	Rename the personalized custom profile.
Memory Recall	Resets all settings to their default values.

> Advanced Features and Settings

This section describes advanced features of the monitor.

Adaptive Sync

Enabling Adaptive Sync will put an end to choppy gameplay and broken games with fluid, artifact-free performance at virtually any frame rate.

To enable the Adaptive Sync function:

1. Press the [●] key or move the joy key [◀] or [▲] or [▼] to display the On-Screen Display (OSD) Menu.
2. Move the joy key [◀] or [▶] to select **Display**. Then move the joy key [▼] to enter the **Display** menu.
3. Move the joy key [▲] or [▼] to select **Adaptive Sync**. Then move the joy key [▶] to confirm the selection.
4. Move the joy key [▲] or [▼] to select **On** or **Off**. Then press the [●] key to confirm the selection.

NOTE: To use the G-Sync function, a DisplayPort connection must be used. Additionally, please note:

1. Your computer must be equipped with a GeForce GTX 10-Series or GeForce RTX 20-Series graphics card.
2. The latest GeForce Driver should be installed.
3. For more information on how to enable G-Sync on an Adaptive Sync monitor, please visit: <https://www.nvidia.com/en-us/geforce/news/geforce-rtx-2060-g-sync-compatible-game-ready-driver/> .

PureXP™

Short for “Pure Experience”, this feature can enhance the visual quality of moving objects, making them less vague with a clearer view. XP is also a play on the life bar in some games. XP is a common & cool way for naming, just like video industry, video effect as VFX. It also adds a more gaming & technological touch.

This is ViewSonic’s exclusive technology to optimize the moving picture response time (MPRT) for better performance during gaming.

NOTE: Only available for refresh rates above 100Hz.

To enable the PureXP™ function:

1. Press the [●] key or move the joy key [◀] or [▲] or [▼] to display the On-Screen Display (OSD) Menu.
2. Move the joy key [◀] or [▶] to select **Display**. Then move the joy key [▼] to enter the **Display** menu.
3. Move the joy key [▲] or [▼] to select **PureXP™**. Then move the joy key [▶] to confirm the selection.
4. Move the joy key [▲] or [▼] to select your preferred experience. Then press the [●] key to confirm the selection.

Hertz Limiter

A monitor hertz controller allows users to control how many frames the monitor can output. The monitor will put a cap on the maximum amount of frames that can be rendered from the monitor to save power and loading from the monitor’s side.

To adjust the Hertz Limiter:

1. Press the [●] key or move the joy key [◀] or [▲] or [▼] to display the On-Screen Display (OSD) Menu.
2. Move the joy key [◀] or [▶] to select **Display**. Then move the joy key [▼] to enter the **Display** menu.
3. Move the joy key [▲] or [▼] to select **Hertz Limiter**. Then move the joy key [▶] to confirm the selection.
4. Move the joy key [▲] or [▼] to select your preferred frame output. Then press the [●] key to confirm the selection.

Menu Options
Native
60Hz
100Hz
144Hz
165Hz

NOTE:

- If Adaptive Sync is “On”, Hertz Limiter will be disabled.
- ViewScale may not support all Hz levels.

Response Time OD

Adjusting the Response Time OD setting will allow the user to fine-tune their desired response time. With five (5) settings to choose from, users can precisely select the best fit for each use scenario.

Each setting will increase response time speed, allowing users the ability to match their PC and game type, creating a “best fit” scenario.

To enable the Response Time OD function:

1. Press the [●] key or move the joy key [◀] or [▲] or [▼] to display the On-Screen Display (OSD) Menu.
2. Move the joy key [◀] or [▶] to select **Display**. Then move the joy key [▼] to enter the **Display** menu.
3. Move the joy key [▲] or [▼] to select **Response Time OD**. Then move the joy key [▶] to confirm the selection.
4. Move the joy key [▲] or [▼] to select your preferred response time. Then press the [●] key to confirm the selection.

Blue Light Filter and Eye Health

The Blue Light Filter blocks high-energy blue light for a more comfortable viewing experience.

Quick Access Blue Light Filter Setup

Enabling and disabling the Blue Light Filter can be done on the fly via the **Quick Access Key**.

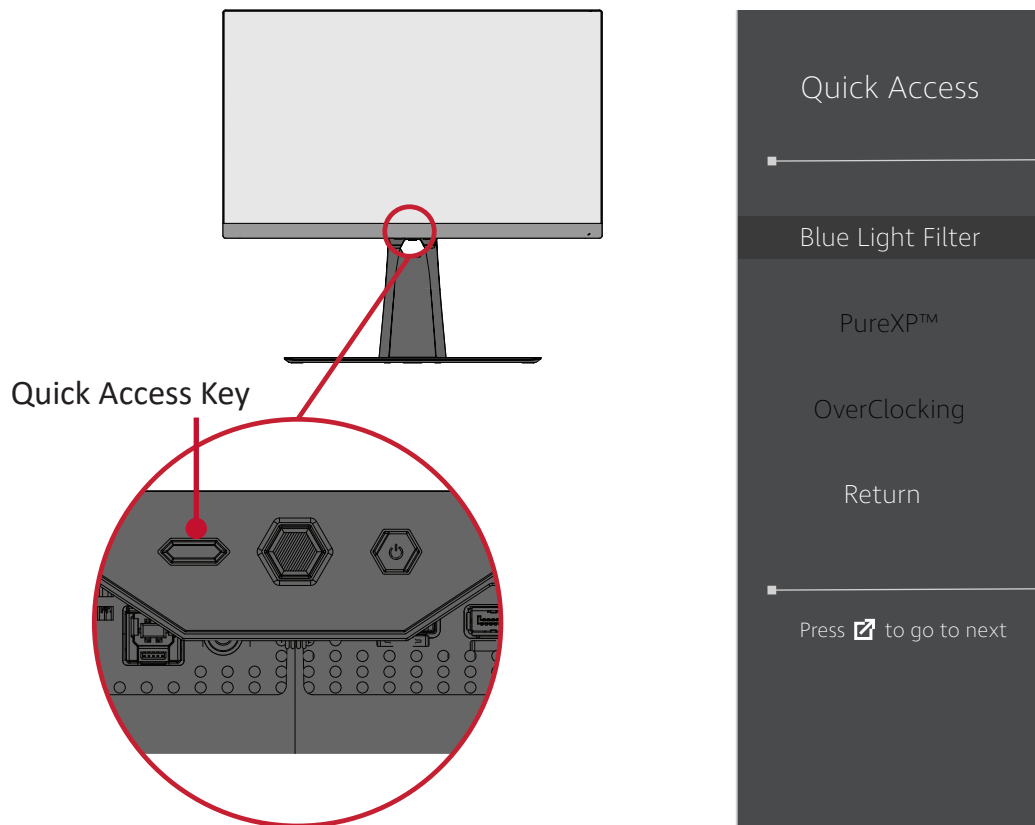

NOTE: When enabling the Blue Light Filter (BLF) via the **Quick Access Key**, the BLF value will be 100 which is certified by TÜV. However, the BLF value will be 0 if the user chooses another function via the **Quick Access Key**.

While using and enjoying your monitor please keep the following in mind:

- Viewing computer screens for extended periods of time may cause eye irritation and discomfort. To reduce these effects, it is recommended to take periodic breaks from viewing to allow the eyes to relax.
- Users can customize the Blue Light Filter value through the **Display Menu**.



- The monitor also supports Flicker-Free, which reduces or eliminates screen flicker, thus easing potential eye strain.

Calculating Breaks

When viewing the monitor for extended periods, it is recommended to take periodic breaks from viewing. Short breaks of at least five (5) minutes are recommended after one (1) to two (2) hours of continuous viewing.

Taking shorter, more frequent breaks are generally more beneficial than longer, less frequent breaks.

Looking at Distant Objects

While taking breaks, users can further reduce eye strain and dryness by focusing on objects that are further away from them.

Eye and Neck Exercises

Eye Exercises

Eye exercises can help minimize eye strain. Slowly roll your eyes to the left, right, up, and down. Repeat as many times as needed.

Neck Exercises

Neck exercises can also help minimize eye strain. Relax your arms and let them hang at your sides, bend forward slightly to stretch the neck, turn your head to the right and to the left. Repeat as many times as needed.

ViewScale

Under ViewScale, users can adjust their current aspect ratio to fit their specific usage scenario. Below are the listed aspect ratios.

NOTE: If users choose a ViewScale aspect mode that is not native, it may impact the user's experience.

To enable ViewScale:

1. Press the [●] key or move the joy key [◀] or [▲] or [▼] to display the On-Screen Display (OSD) Menu.
2. Move the joy key [◀] or [▶] to select **Display**. Then move the joy key [▼] to enter the **Display** menu.
3. Move the joy key [▲] or [▼] to select **Image Adjust** Then move the joy key [▶] to enter its sub-menu.
4. Move the joy key [▲] or [▼] to select **ViewScale**. Then move the joy key [▶] to enter its sub-menu.
5. Move the joy key [▲] or [▼] to select your preferred aspect ratio. Then press the [●] key to confirm the selection.

Aspect Ratio	Description
Full	Scales the inputted image to fill the screen, this is the default input choice and is ideal for 16:9 images.
Aspect	The inputted image is allowed to fill the screen as large as it can go without image distortion.
1:1	The image is directly displayed without scaling.
19" (4:3)	Simulates the inputted image in a 4:3 aspect ratio and 19" display size.
19"W (16:10)	Simulates the inputted image in a 16:10 aspect ratio and 19"W display size.
21.5" (16:9)	Simulates the inputted image in a 16:9 aspect ratio and 21.5" display size.
22"W (16:10)	Simulates the inputted image in a 16:10 aspect ratio and 22"W display size.
23.6"W (16:9)	Simulates the inputted image in a 16:9 aspect ratio and 23.6"W display size.
24"W (16:9)	Simulates the inputted image in a 16:9 aspect ratio and 24"W display size.

Quick Access

Quickly initiate some functions and modes through the Quick Access key and menu. Users can also define which functions or modes they prefer in the Quick Access Menu via the **Setup Menu** in OSD. The function/mode will be enabled as soon as the light-bar moves on the item, and will disable after removing the light-bar.

In the Quick Access Menu, “Return” means users can “automatically” go back to the mode they chose before entering the Quick Access Menu.

For example, if users chose “Console Speed” mode before entering the Quick Access Menu and there is an existing FPS option in the Quick Access Menu, according to the Quick Access definition, users will enable FPS mode when the light-bar moves on the item. Then, when moving the light-bar to “Return,” the mode will be changed into “Console Speed” automatically which is same as the mode before user entering the Quick Access Menu.

To activate the Quick Access Menu:

1. Press the **Quick Access Key** to display the Quick Access Menu.
2. Press the **Quick Access Key** to select your preference.

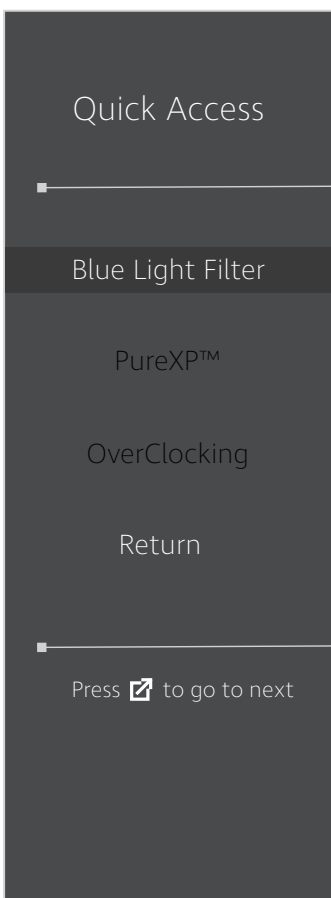

NOTE:

- To change the Quick Access Menu’s default functions (Blue Light Filter, PureXP™, and OverClocking), remove one or more default functions via the OSD **Setup Menu** first.
- The Quick Access Menu will disappear after three (3) seconds automatically.

To Change the Quick Access Menu options:

1. Press the [●] key or move the joy key [◀] or [▲] or [▼] to display the On-Screen Display (OSD) Menu.
2. Move the joy key [◀] or [▶] to select **Setup Menu**. Then move the joy key [▼] to enter the **Setup Menu** menu.
3. Move the joy key [▲] or [▼] to select **Quick Access**. Then move the joy key [▶] to enter its sub-menu.
4. Move the joy key [▲] or [▼] to select your preference. Then press the [●] key to confirm the selection.

NOTE: Some sub-menu options may have another sub-menu. To enter the respective sub-menu, move the joy key [▶].

Elite RGB Lighting

This setting controls the RGB lighting on the back of the monitor and beneath the bezel. When “On”, or after being reset, the default ‘Breathing’ mode will be active.

To enter the Elite RGB menu:

1. Press the [●] key or move the joy key [◀] or [▲] or [▼] to display the On-Screen Display (OSD) Menu.
2. Move the joy key [◀] or [▶] to select **Setup Menu**. Then move the joy key [▼] to enter the **Setup Menu** menu.
3. Move the joy key [▲] or [▼] to select **Elite RGB**. Then move the joy key [▶] to enter its sub-menu.
4. Move the joy key [▲] or [▼] to select your preference. Then press the [●] key to confirm the selection.

NOTE: Some sub-menu options may have another sub-menu. To enter the respective sub-menu, move the joy key [▶].

In addition, the RGB backlights are also synced with several key partners. Downloading their software will give you the power to adjust your RGB capabilities further.

To setup up partner RGB software:

1. Visit: <https://www.viewsonic.com/elite/rgb/>
2. Select a partner RGB software, and download it.
3. Connect one end of the USB Type B cable to the monitor and the other end to your computer.
4. Run and install the partner software.
5. Start customizing the monitor’s RGB lighting.

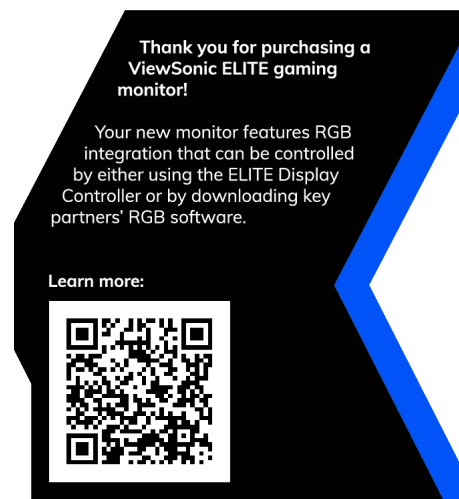
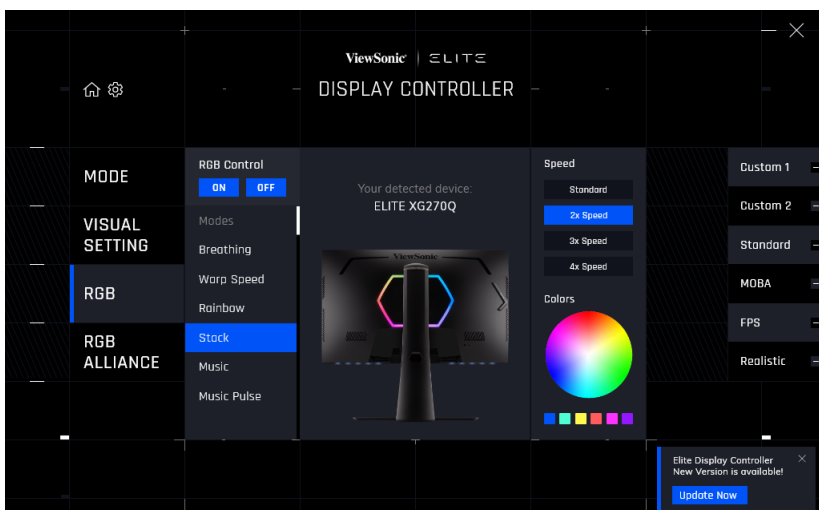



Crosshair

Select from different crosshair styles and colors to overlay on your screen.

To enable the Crosshair function:

1. Press the [●] key or move the joy key [◀] or [▲] or [▼] to display the On-Screen Display (OSD) Menu.
2. Move the joy key [◀] or [▶] to select **Setup Menu**. Then move the joy key [▼] to enter the **Setup Menu** menu.
3. Move the joy key [▲] or [▼] to select **Crosshair**. Then move the joy key [▶] to confirm the selection.
4. Move the joy key [▲] or [▼] to select your preferred crosshair style and color. Then press the [●] key to confirm the selection.

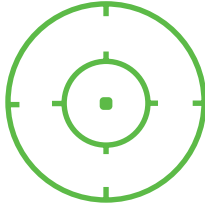
NOTE: A preview image of the crosshair (type and color) will be displayed on the right side of the OSD Menu before confirming.

Crosshair	Description
Type A	
Type B	
Type C	

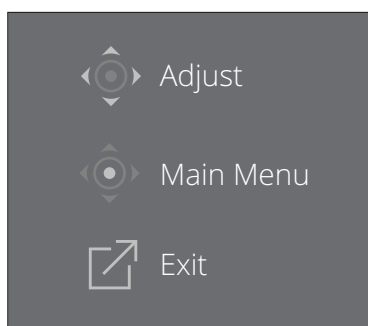

NOTE: This message box will appear with the crosshair, and disappear after three (3) seconds automatically.

Firmware Update

For the best display performance and to resolve any known issues, it is best to keep your monitor updated with the latest firmware version. With the USB cable and firmware update tool, you can easily update your monitor firmware any time.

You can visit: <https://www.viewsonic.com/elite/display-controller/> to check and download the latest firmware version with the update tool.

To update the firmware:

1. Check and download the Firmware Update Tool with latest firmware version for your monitor from: <http://www.viewsonic.com/elite/display-controller/>.
2. Connect the USB Type B male cable (square with 2 cut corners) to the USB Type B port of your monitor. Then connect the other end of the cable to the USB port of the computer.

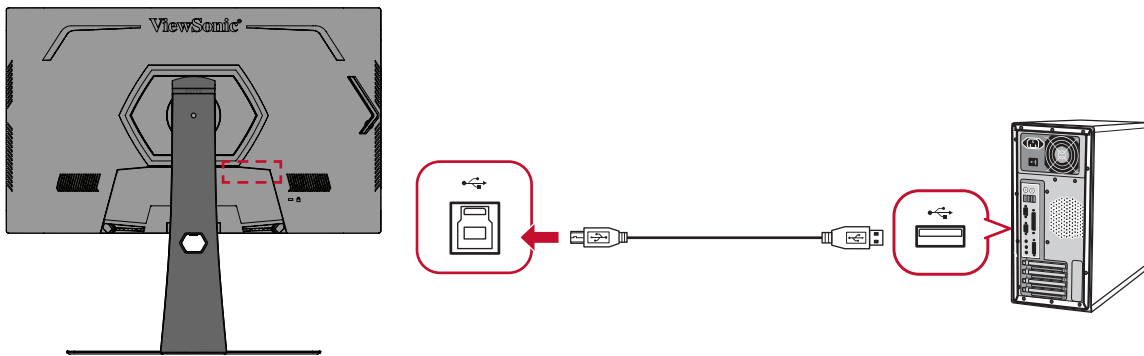

3. Unzip the downloaded Firmware Update Tool and double-click on the .exe file or .pkg file. Then follow the on-screen instructions to complete the application installation.
4. Launch the Firmware Update Tool. The application will automatically detect and verify your monitor model and current firmware version.

5. Click **Update** to upgrade your monitor firmware.



6. Wait until the upgrade process is complete.

NOTE:

- Any interruptions during the firmware upgrade process may permanently damage your monitor. Do not disconnect the USB cable or turn off your PC and monitor.
- By using the Elite Display Controller, users can receive an auto-notification when new firmware is available.

> Appendix

Specifications

Item	Category	Specifications
LCD	Type	TFT, Active Matrix 2560 x 1440 LCD, 0.27675 mm x 0.27675 mm pixel pitch
	Display Size	81.29 cm, 32"
	Color Filter	RGB vertical stripe
	Glass Surface	Anti-Glare type, 3H hard coating
Input Signal	Video Sync	<u>TMDS digital (100 Ω)</u> HDMI: f_h :30-230 kHz, f_v :48-144 Hz DisplayPort: f_h :30-254 kHz, f_v :48-175 Hz
Compatibility	PC	up to 2560 x 1440
	Macintosh	up to 2560 x 1440
	Recommended	2560 x 1440 @ 165Hz
Resolution ¹	Supported	<ul style="list-style-type: none"> • 2560 x 1440 @ 120, 144, 165, 175Hz (DP) • 2560 x 1440 @ 120, 144Hz (HDMI) • 1920 x 1200 @ 60Hz • 1920 x 1080 @ 120Hz • 1680 x 1050 @ 60Hz • 1600 x 1200 @ 60Hz • 1280 x 1024 @ 60, 75Hz • 1280 x 800 @ 60Hz • 1152 x 864 @ 75Hz • 1024 x 768 @ 60, 70, 75Hz • 800 x 600 @ 56, 60, 72, 75Hz • 720 x 400 @ 70Hz • 640 x 480 @ 60, 67, 72, 75Hz
Power Adapter ²	Input Voltage	AC 100-240V, 50/60Hz (auto switch)
Display Area	Full Scan (H x V)	708.48 x 398.52 mm (27.89" x 15.68")
Operating conditions	Temperature	0° C to 40° C (32° F to 104° F)
	Humidity	20% to 90% (non-condensing)
	Altitude	10,000 feet (3.048 km)
Storage conditions	Temperature	-20° C to 60° C (-4° F to 140° F)
	Humidity	5% to 90% (non-condensing)
	Altitude	40,000 feet (12.1 km)

Item	Category	Specifications
Dimensions	Physical (W x H x D)	726.28 x 482.3~602.3 x 265.21 mm (28.59" x 18.99~23.71" x 10.44")
Wall Mount	Dimensions	100 x 100 mm
Weight	Physical	14.56 kg (32.1 lbs)
Power saving modes	On ³	43.8W (Typical) ⁴
	Off	< 0.3W (Max)

¹ Do not set the graphics card in your computer to exceed these timing modes; doing so may result in permanent damage to the display.

² Please use the power adapter from ViewSonic® or an authorized source only.

³ The test condition follows EEI standards.

⁴ Without USB and audio.



Glossary

This section describes the standard glossary of terms used in all LCD display models. All terms are listed in alphabetical order.

NOTE: Some terms may not be applicable to your monitor.

A

Advanced DCR

Advanced DCR technology automatically detects the image signal and intelligently controls the backlight brightness and color to improve on the ability to make the black blacker in a dark scene, and make the white whiter in a bright environment.

Adaptive Sync

Adaptive Sync technology puts an end to choppy gameplay and broken frames with fluid, artifact-free performance at virtually any frame rate.

Audio Adjust

Adjusts the volume, mutes the sound, or toggles between inputs if you have more than one source.

Auto Detect

If the current input source has no signal, the monitor will automatically switch to the next input option. This function, on some models, is disabled by default.

B

Black Stabilization

ViewSonic's Black Stabilization provides heightened visibility and detail by brightening dark scenes.

Blue Light Filter

Adjusts the filter that blocks high-energy blue light for a more comfortable viewing experience.

Boot Up Screen

Turning off the boot screen will disable the on-screen message from displaying when turning on the monitor.

Brightness

Adjusts background black levels of the screen image.

C Color Adjust

Provides several color adjustment modes to help adjust the color settings to fit the user's needs.

Color Range

The monitor can detect the input signal color range automatically. You can manually change the color range options to fit the correct color range if the colors are not displayed correctly.

Options	Description
Auto	The monitor automatically recognizes the color format and black and white levels.
Full Range	The color range of the black and white levels are full.
Limited Range	The color range of the black and white levels are limited.

Color Space

Allows users to choose which color space they would like to use for monitor color output (RGB, YUV).

Color Temperature

Allows users to select specific color temperature settings to further customize their viewing experience.

Panel Default	Panel Original Status
sRGB	Standard color space used for the Windows system.
Bluish	Set the color temperature to 9300K.
Cool	Set the color temperature to 7500K.
Native	Default color temperature. Recommended for general use.
Warm	Set the color temperature to 5000K.

ColorX

A unique color mode, balancing speed and color, for fast-paced action. Best for games that require twitch-like reflexes and precise color for quick reactions.

Contrast

Adjusts the difference between the image background (black level) and the foreground (white level).

Crosshair

Select from different crosshair styles and colors to overlay on your screen.

E Elite RGB Lighting

This setting controls the RGB lighting on the back of the monitor and beneath the bezel. Both the color and style of the RGB lighting can be adjusted.

G Game Mode

Integrating a gaming-oriented OSD design including pre-calibrated FPS, RTS, and MOBA gaming settings. Each mode is functionally customized with in-game testing and adjustments made for the best blend of color and technology.

Gamma

Allows users to manually adjust the brightness level of the monitor's grayscale levels. There are six selections: 1.8, 2.0, 2.2, 2.4, 2.6, and 2.8.

H Hertz Limiter

Allows users to control how many frames the monitor can output. The monitor will put a cap on the maximum amount of frames that can be rendered from the monitor to save power and loading from the monitor's side.

Hue

Adjusts the tint of each color (red, green, blue, cyan, magenta, and yellow).

I Information

Displays the timing mode (video signal input) coming from the graphics card in the computer, the LCD model number, the serial number, and the ViewSonic® website URL. See your graphics card's user guide for instructions on changing the resolution and refresh rate (vertical frequency).

NOTE: VESA 1024 x 768 @ 60Hz, for example, means that the resolution is 1024 x 768 and the refresh rate is 60Hz.

Input Select

Toggles between the various input options that are available for the monitor.

- L Low Input Lag**
ViewSonic® offers low input lag, utilizing a monitor process reducer, which decreases signal latency. Under the “Low Input Lag” sub-menu, you can select the appropriate speed for your desired use from the options.
- M Manual Image Adjust**
Displays the “Manual Image Adjust” menu. You can manually set a variety of image quality adjustments.
- Memory Recall**
Returns the adjustments back to factory settings if the display is operating in a factory preset timing mode listed in the “Specifications” of this manual.
- NOTE:** (Exception) This control does not affect changes made in the “Language Select” or “Power Lock” setting.
- O Offset**
Adjusts black levels for red, green, and blue. The gain and offset functions allow users to control the white balance for the upmost control when manipulating contrast and dark scenes.
- OSD Pivot**
Sets the monitor OSD Menu display direction.
- Overscan**
Refers to a cropped image on your monitor’s screen. A setting on your monitor zooms in on movie content, so that you cannot see the outermost edges of the film.
- P Power Indicator**
The light that displays whether the monitor is on or off. This setting also controls the lighting on the stand. Users can turn off the lighting effect under “Power Indicator”. Additionally, the power indicator displays an average color directly interpreting the input color signal received on screen.
- PureXP™**
Short for “Pure Experience”, this feature can enhance the visual quality of moving objects, making them less vague with a clearer view. XP is also a play on the life bar in some games. XP is a common & cool way for naming, just like video industry, video effect as VFX. It also adds a more gaming & technological touch.

Q Quick Access
Quickly initiate some functions and modes through the Quick Access key and menu. Users can also define which functions or modes they prefer in the Quick Access Menu via the **Setup Menu** in OSD. The function/mode will be enabled as soon as the light-bar moves on the item, and will disable after removing the light-bar.

R Recall
Resets the ViewMode monitor settings.

Resolution Notice

The notice tells users that the current viewing resolution is not the correct native resolution. This notice will appear in the display settings window when setting up the display resolution.

Response Time OD

An advanced tuning function for users that want to adjust their monitor's response time. They can select from five (5) different levels to more precisely tune the response to be as fast as needed while reducing blurring or ghosting based on each unique gaming scenario.

S Setup Menu
Adjusts On-Screen Display (OSD) Menu settings. Many of these settings can activate on-screen display notifications so users do not have to reopen the menu.

Sharpness

Adjusts the picture quality of the monitor.

V ViewMode
ViewSonic's unique ViewMode feature offers "Game", "Movie", "Web", "Text", "MAC", and "Mono" presets. These presets are specifically designed to deliver an optimized viewing experience for different screen applications.

ViewScale

Gamers have the ability to adjust the display size of the image on the monitor, allowing for a "best fit" scenario.

Troubleshooting

This section describes some common problems that you may experience when using the monitor.

Problem or Issue	Possible Solutions
No power	<ul style="list-style-type: none">• Make sure you have turned on the monitor by pressing the Power button.• Make sure the power cord is properly and securely connected to the monitor and power outlet.• Plug another electrical device into the power outlet to verify that the outlet is supplying power.
Power is On, but no image appears on screen	<ul style="list-style-type: none">• Make sure the video cable connecting the monitor to the computer is properly and securely connected.• Adjust the brightness and contrast settings.• Make sure the correct input source is selected.
Wrong or abnormal colors	<ul style="list-style-type: none">• If any colors (red, green, or blue) are missing, check the video cable to make sure it is properly and securely connected. Loose or broken pins in the cable connector could cause an improper connection.• Connect the monitor to another computer.• If you have an older graphics card, contact ViewSonic® for a non-DDC adapter.
Screen image is too light or dark	<ul style="list-style-type: none">• Adjust brightness and contrast settings via the OSD Menu.• Reset the monitor to factory settings.
Screen image cuts in and out	<ul style="list-style-type: none">• Make sure the correct input source is selected.• Check for bent or broken pins in the video cable connector.• Make sure the video cable connecting the monitor to the computer is properly and securely connected.
Screen image is blurred	<ul style="list-style-type: none">• Adjust the resolution to the correct Aspect Ratio.• Reset the monitor to factory settings.

Problem or Issue	Possible Solutions
The screen isn't centered correctly	<ul style="list-style-type: none"> • Adjust the horizontal and vertical controls via the OSD Menu. • Check the Aspect Ratio. • Reset the monitor to factory settings.
The screen appears yellow	<ul style="list-style-type: none"> • Make sure the "Blue Light Filter" is Off.
The OSD Menu does not appear on the screen/the OSD controls are inaccessible	<ul style="list-style-type: none"> • Check whether the OSD Menu is locked. • Turn off the monitor, unplug the power cord, plug it back in, and then turn on the monitor. • Reset the monitor to factory settings.
Control panel keys do not work	<ul style="list-style-type: none"> • Press only one key at a time. • Restart the computer.
Some menus aren't selectable in the OSD	<ul style="list-style-type: none"> • Adjust the ViewMode or the input source. • Reset the monitor to factory settings.
No audio output	<ul style="list-style-type: none"> • If using ear-/headphones, ensure the mini stereo jack is connected. • Make sure the volume is not muted, nor set to 0. • Check the Audio Input setting.
The monitor will not adjust	<ul style="list-style-type: none"> • Make sure there are no obstructions near or on the monitor, and that there is adequate spacing. • For more information, see "Adjusting the Viewing Angle".
USB devices connected to the monitor do not work	<ul style="list-style-type: none"> • Make sure the USB cable is connected properly. • Try changing to another USB port (if applicable). • Some USB devices require a higher electric current; connect the device directly to the computer.
The external device is connected, but no image appears on the screen	<ul style="list-style-type: none"> • Make sure the Power is On • Adjust brightness and contrast via the OSD Menu. • Check the connecting cable and make sure it is properly and securely connected. Loose or broken pins in the cable connector could cause an improper connection.

Maintenance

General Precautions

- Make sure the monitor is turned off and the power cable is unplugged from the power outlet.
- Never spray or pour any liquid directly onto the screen or case.
- Handle the monitor with care, as a darker-colored monitor, if scuffed, may show marks more clearly than a lighter-colored monitor.

Cleaning the Screen

- Wipe the screen with a clean, soft, lint-free cloth. This removes dust and other particles.
- If the screen is still not clean, apply a small amount of non-ammonia, non-alcohol based glass cleaner onto a clean, soft, lint-free cloth; then wipe the screen.

Cleaning the Case

- Use a soft, dry cloth.
- If the case is still not clean, apply a small amount of non-ammonia, non-alcohol based, mild non-abrasive detergent onto a clean, soft, lint-free cloth, then wipe the surface.

Disclaimer

- ViewSonic® does not recommend the use of any ammonia or alcohol-based cleaners on the display screen or case. Some chemical cleaners have been reported to damage the screen and/or case of the monitor.
- ViewSonic® will not be liable for damage resulting from use of any ammonia or alcohol-based cleaners.

> Regulatory and Service Information

Compliance Information

This section addresses all connected requirements and statements regarding regulations. Confirmed corresponding applications shall refer to nameplate labels and relevant markings on the unit.

FCC Compliance Statement

This device complies with part 15 of FCC Rules. Operation is subject to the following two conditions: (1) this device may not cause harmful interference, and (2) this device must accept any interference received, including interference that may cause undesired operation. This equipment has been tested and found to comply with the limits for a Class B digital device, pursuant to part 15 of the FCC Rules.

These limits are designed to provide reasonable protection against harmful interference in a residential installation. This equipment generates, uses, and can radiate radio frequency energy, and if not installed and used in accordance with the instructions, may cause harmful interference to radio communications. However, there is no guarantee that interference will not occur in a particular installation. If this equipment does cause harmful interference to radio or television reception, which can be determined by turning the equipment off and on, the user is encouraged to try to correct the interference by one or more of the following measures:

- Reorient or relocate the receiving antenna.
- Increase the separation between the equipment and receiver.
- Connect the equipment into an outlet on a circuit different from that to which the receiver is connected.
- Consult the dealer or an experienced radio/TV technician for help.

Warning: You are cautioned that changes or modifications not expressly approved by the party responsible for compliance could void your authority to operate the equipment.

Industry Canada Statement

CAN ICES-003(B) / NMB-003(B)

The following information is only for EU-member states:

The mark shown to the right is in compliance with the Waste Electrical and Electronic Equipment Directive 2012/19/EU (WEEE). The mark indicates the requirement NOT to dispose of the equipment as unsorted municipal waste, but use the return and collection systems according to local law.



Declaration of RoHS2 Compliance

This product has been designed and manufactured in compliance with Directive 2011/65/EU of the European Parliament and the Council on restriction of the use of certain hazardous substances in electrical and electronic equipment (RoHS2 Directive) and is deemed to comply with the maximum concentration values issued by the European Technical Adaptation Committee (TAC) as shown below:

Substance	Proposed Maximum Concentration	Actual Concentration
Lead (Pb)	0.1%	< 0.1%
Mercury (Hg)	0.1%	< 0.1%
Cadmium (Cd)	0.01%	< 0.01%
Hexavalent Chromium (Cr6 ⁺)	0.1%	< 0.1%
Polybrominated biphenyls (PBB)	0.1%	< 0.1%
Polybrominated diphenyl ethers (PBDE)	0.1%	< 0.1%
Bis (2-ethylhexyl) phthalate (DEHP)	0.1%	< 0.1%
Butyl benzyl phthalate (BBP)	0.1%	< 0.1%
Dibutyl phthalate (DBP)	0.1%	< 0.1%
Diisobutyl phthalate (DIBP)	0.1%	< 0.1%

Certain components of products as stated above are exempted under the Annex III of the RoHS2 Directives as noted below. Examples of exempted components are:

- Lead as an alloying element in aluminum containing up to 0.4% lead by weight.
- Copper alloy containing up to 4% lead by weight.
- Lead in high melting temperature type solders (i.e. lead-based alloys containing 85% by weight or more lead).
- Electrical and electronic components containing lead in a glass or ceramic other than dielectric ceramic in capacitors, e.g. piezoelectronic devices, or in a glass or ceramic matrix compound.

Indian Restriction of Hazardous Substances

Restriction on Hazardous Substances statement (India). This product complies with the “India E-waste Rule 2011” and prohibits use of lead, mercury, hexavalent chromium, polybrominated biphenyls or polybrominated diphenyl ethers in concentrations exceeding 0.1 weight % and 0.01 weight % for cadmium, except for the exemptions set in Schedule 2 of the Rule.

Product Disposal at End of Product Life

ViewSonic® respects the environment and is committed to working and living green. Thank you for being part of Smarter, Greener Computing. Please visit the ViewSonic® website to learn more.

USA & Canada:

<http://www.viewsonic.com/company/green/recycle-program/>

Europe:

<http://www.viewsoniceurope.com/eu/support/call-desk/>

Taiwan:

<https://recycle.epa.gov.tw/>

Copyright Information

Copyright© ViewSonic® Corporation, 2021. All rights reserved.

Macintosh and Power Macintosh are registered trademarks of Apple Inc.

Microsoft, Windows, and the Windows logo are registered trademarks of Microsoft Corporation in the United States and other countries.

ViewSonic®, the three birds logo, OnView, ViewMatch, and ViewMeter are registered trademarks of ViewSonic® Corporation.

VESA is a registered trademark of the Video Electronics Standards Association. DPMS, DisplayPort, and DDC are trademarks of VESA.

ENERGY STAR® is a registered trademark of the U.S. Environmental Protection Agency (EPA).

As an ENERGY STAR® partner, ViewSonic® Corporation has determined that this product meets the ENERGY STAR® guidelines for energy efficiency.

Disclaimer: ViewSonic® Corporation shall not be liable for technical or editorial errors or omissions contained herein; nor for incidental or consequential damages resulting from furnishing this material, or the performance or use of this product.

In the interest of continuing product improvement, ViewSonic® Corporation reserves the right to change product specifications without notice. Information in this document may change without notice.

No part of this document may be copied, reproduced, or transmitted by any means, for any purpose without prior written permission from ViewSonic® Corporation.

Customer Service

For technical support or product service, see the table below or contact your reseller.

NOTE: You will need the product's serial number.

Country/ Region	Website	Country/ Region	Website
Asia Pacific & Africa			
Australia	www.viewsonic.com/au/	Bangladesh	www.viewsonic.com/bd/
中国 (China)	www.viewsonic.com.cn	香港 (繁體中文)	www.viewsonic.com/hk/
Hong Kong (English)	www.viewsonic.com/hk-en/	India	www.viewsonic.com/in/
Indonesia	www.viewsonic.com/id/	Israel	www.viewsonic.com/il/
日本 (Japan)	www.viewsonic.com/jp/	Korea	www.viewsonic.com/kr/
Malaysia	www.viewsonic.com/my/	Middle East	www.viewsonic.com/me/
Myanmar	www.viewsonic.com/mm/	Nepal	www.viewsonic.com/np/
New Zealand	www.viewsonic.com/nz/	Pakistan	www.viewsonic.com/pk/
Philippines	www.viewsonic.com/ph/	Singapore	www.viewsonic.com/sg/
臺灣 (Taiwan)	www.viewsonic.com/tw/	ประเทศไทย	www.viewsonic.com/th/
Việt Nam	www.viewsonic.com/vn/	South Africa & Mauritius	www.viewsonic.com/za/
Americas			
United States	www.viewsonic.com/us	Canada	www.viewsonic.com/us
Latin America	www.viewsonic.com/la		
Europe			
Europe	www.viewsonic.com/eu/	France	www.viewsonic.com/fr/
Deutschland	www.viewsonic.com/de/	Қазақстан	www.viewsonic.com/kz/
Россия	www.viewsonic.com/ru/	España	www.viewsonic.com/es/
Türkiye	www.viewsonic.com/tr/	Україна	www.viewsonic.com/ua/
United Kingdom	www.viewsonic.com/uk/		

Limited Warranty

ViewSonic® Display

What the warranty covers:

ViewSonic® warrants its products to be free from defects in material and workmanship during the warranty period. If a product proves to be defective in material or workmanship during the warranty period, ViewSonic® will, at its sole option, and as your sole remedy, repair or replace the product with a similar product. Replacement Product or parts may include remanufactured or refurbished parts or components. The repair or replacement unit or parts or components will be covered by the balance of the time remaining on the customer's original limited warranty and the warranty period will not be extended. ViewSonic® provides no warranty for any third-party software whether included with the product or installed by the customer, installation of any unauthorized hardware parts or components (e.g. Projector Lamps). (Please refer to: "What the warranty excludes and does not cover" section).

How long the warranty is effective:

ViewSonic® displays are warranted for between 1 and 3 years, depending on your country of purchase, for all parts including the light source and for all labor from the date of the first consumer purchase.

Who the warranty protects:

This warranty is valid only for the first consumer purchaser.

What the warranty excludes and does not cover:

- Any product on which the serial number has been defaced, modified, or removed.
- Damage, deterioration, or malfunction resulting from:
 - » Accident, misuse, neglect, fire, water, lightning, or other acts of nature, unauthorized product modification, or failure to follow instructions supplied with the product.
 - » Repair or attempted repair by anyone not authorized by ViewSonic®.
 - » Damage to or loss of any programs, data, or removable storage media.
 - » Normal wear and tear.
 - » Removal or installation of the product.
- Software or data loss occurring during repair or replacement.
- Any damage of the product due to shipment.

- Causes external to the product, such as electric power fluctuations or failure.
- Use of supplies or parts not meeting ViewSonic’s specifications.
- Failure of owner to perform periodic product maintenance as stated in the User Guide.
- Any other cause which does not relate to a product defect.
- Damage caused by static (non-moving) images displayed for lengthy periods of time (also referred to as image burn-in).
- Software - Any third-party software included with the product or installed by the customer.
- Hardware/Accessories/Parts/Components – Installation of any unauthorized hardware, accessories, consumable parts or components (e.g. Projector Lamps).
- Damage to, or abuse of, the coating on the surface of the display through inappropriate cleaning as described in the product User Guide.
- Removal, installation, and set-up service charges, including wall-mounting of the product.

How to get service:

- For information about receiving service under warranty, contact ViewSonic® Customer Support (Please refer to the “Customer Service” page). You will need to provide your product’s serial number.
- To obtain warranty service, you will be required to provide: (a) the original dated sales slip, (b) your name, (c) your address, (d) a description of the problem, and (e) the serial number of the product.
- Take or ship the product, freight prepaid, in the original container to an authorized ViewSonic® service center or ViewSonic®.
- For additional information or the name of the nearest ViewSonic® service center, contact ViewSonic®.

Limitation of implied warranties:

There are no warranties, express or implied, which extend beyond the description contained herein including the implied warranty of merchantability and fitness for a particular purpose.

Exclusion of damages:

ViewSonic's liability is limited to the cost of repair or replacement of the product. ViewSonic® shall not be liable for:

- Damage to other property caused by any defects in the product, damages based upon inconvenience, loss of use of the product, loss of time, loss of profits, loss of business opportunity, loss of goodwill, interference with business relationships, or other commercial loss, even if advised of the possibility of such damages.
- Any other damages, whether incidental, consequential or otherwise.
- Any claim against the customer by any other party.
- Repair or attempted repair by anyone not authorized by ViewSonic®.

Effect of state law:

This warranty gives you specific legal rights, and you may also have other rights which vary from state to state. Some states do not allow limitations on implied warranties and/or do not allow the exclusion of incidental or consequential damages, so the above limitations and exclusions may not apply to you.

Sales outside the U.S.A. and Canada:

For warranty information and service on ViewSonic® products sold outside of the U.S.A. and Canada, contact ViewSonic® or your local ViewSonic® dealer.

The warranty period for this product in mainland China (Hong Kong, Macao, and Taiwan Excluded) is subject to the terms and conditions of the Maintenance Guarantee Card.

For users in Europe and Russia, full details of warranty provided can be found at: <http://www.viewsonic.com/eu/> under "Support/Warranty Information".

Mexico Limited Warranty

ViewSonic® Display

What the warranty covers:

ViewSonic® warrants its products to be free from defects in material and workmanship, under normal use, during the warranty period. If a product proves to be defective in material or workmanship during the warranty period, ViewSonic® will, at its sole option, repair or replace the product with a like product. Replacement product or parts may include remanufactured or refurbished parts or components & accessories.

How long the warranty is effective:

ViewSonic® LCD displays are warranted for between 1 and 3 years, depending on your country of purchase, for all parts including the light source and for all labour from the date of the first consumer purchase.

Who the warranty protects:

This warranty is valid only for the first consumer purchaser.

What the warranty excludes and does not cover:

- Any product on which the serial number has been defaced, modified or removed.
- Damage, deterioration, or malfunction resulting from:
 - » Accident, misuse, neglect, fire, water, lightning, or other acts of nature, unauthorized product modification, unauthorized attempted repair, or failure to follow instructions supplied with the product.
 - » Causes external to the product, such as electrical power fluctuations or failure.
 - » Use of supplies or parts not meeting ViewSonic®'s specifications.
 - » Normal wear and tear.
 - » Any other cause which does not relate to a product defect.
- Any product exhibiting a condition commonly known as “image burn-in” which results when a static image is displayed on the product for an extended period of time.
- Removal, installation, insurance, and set-up service charges.

How to get service:

For information about receiving service under warranty, contact ViewSonic® Customer Support (Please refer to the attached “Customer Service” page). You will need to provide your product’s serial number, so please record the product information in the space provided below on your purchase for your future use. Please retain your receipt of proof of purchase to support your warranty claim.

For Your Records

Product Name: _____ Model Number: _____

Document Number: _____ Serial Number: _____

Purchase Date: _____ Extended Warranty Purchase? _____ (Y/N)

If so, what date does warranty expire? _____

- To obtain warranty service, you will be required to provide (a) the original dated sales slip, (b) your name, (c) your address, (d) a description of the problem, and (e) the serial number of the product.
- Take or ship the product, in the original container packaging, to an authorized ViewSonic® service center.
- Round trip transportation costs for in-warranty products will be paid by ViewSonic®.

Limitation of implied warranties:

There are no warranties, express or implied, which extend beyond the description contained herein including the implied warranty of merchantability and fitness for a particular purpose.

Exclusion of damages:

ViewSonic®’s liability is limited to the cost of repair or replacement of the product.

ViewSonic® shall not be liable for:

- Damage to other property caused by any defects in the product, damages based upon inconvenience, loss of use of the product, loss of time, loss of profits, loss of business opportunity, loss of goodwill, interference with business relationships, or other commercial loss, even if advised of the possibility of such damages.
- Any other damages, whether incidental, consequential or otherwise.
- Any claim against the customer by any other party.
- Repair or attempted repair by anyone not authorized by ViewSonic®.

Contact Information for Sales & Authorized Service (Centro Autorizado de Servicio) within Mexico:	
Name, address, of manufacturer and importers: México, Av. de la Palma #8 Piso 2 Despacho 203, Corporativo Interpalmas, Col. San Fernando Huixquilucan, Estado de México Tel: (55) 3605-1099 http://www.viewsonic.com/la/soporte/index.htm	
NÚMERO GRATIS DE ASISTENCIA TÉCNICA PARA TODO MÉXICO: 001.866.823.2004	
Hermosillo: Distribuciones y Servicios Computacionales SA de CV. Calle Juárez 284 local 2 Col. Bugambilias C.P: 83140 Tel: 01-66-22-14-9005 E-Mail: disc2@hmo.megared.net.mx	Villahermosa: Compumantenimientos Garantizados, S.A. de C.V. AV. GREGORIO MENDEZ #1504 COL, FLORIDA C.P. 86040 Tel: 01 (993) 3 52 00 47 / 3522074 / 3 52 20 09 E-Mail: compumantenimientos@prodigy.net.mx
Puebla, Pue. (Matriz): RENTA Y DATOS, S.A. DE C.V. Domicilio: 29 SUR 721 COL. LA PAZ 72160 PUEBLA, PUE. Tel: 01(52).222.891.55.77 CON 10 LINEAS E-Mail: datos@puebla.megared.net.mx	Veracruz, Ver.: CONEXION Y DESARROLLO, S.A DE C.V. Av. Americas # 419 ENTRE PINZÓN Y ALVARADO Fracc. Reforma C.P. 91919 Tel: 01-22-91-00-31-67 E-Mail: gacosta@qplus.com.mx
Chihuahua: Soluciones Globales en Computación C. Magisterio # 3321 Col. Magisterial Chihuahua, Chih. Tel: 4136954 E-Mail: Cefeo@soluglobales.com	Cuernavaca: Compusupport de Cuernavaca SA de CV Francisco Leyva # 178 Col. Miguel Hidalgo C.P. 62040, Cuernavaca Morelos Tel: 01 777 3180579 / 01 777 3124014 E-Mail: aquevedo@compusupportcva.com
Distrito Federal: QPLUS, S.A. de C.V. Av. Coyoacán 931 Col. Del Valle 03100, México, D.F. Tel: 01(52)55-50-00-27-35 E-Mail : gacosta@qplus.com.mx	Guadalajara, Jal.: SERVICRECE, S.A. de C.V. Av. Niños Héroes # 2281 Col. Arcos Sur, Sector Juárez 44170, Guadalajara, Jalisco Tel: 01(52)33-36-15-15-43 E-Mail: mmiranda@servicrece.com
Guerrero Acapulco: GS Computación (Grupo Sesicomp) Progreso #6-A, Colo Centro 39300 Acapulco, Guerrero Tel: 744-48-32627	Monterrey: Global Product Services Mar Caribe # 1987, Esquina con Golfo Pérsico Fracc. Bernardo Reyes, CP 64280 Monterrey N.L. México Tel: 8129-5103 E-Mail: aydeem@gps1.com.mx
MERIDA: ELECTROSER Av Reforma No. 403Gx39 y 41 Mérida, Yucatán, México CP97000 Tel: (52) 999-925-1916 E-Mail: rrrb@sureste.com	Oaxaca, Oax.: CENTRO DE DISTRIBUCION Y SERVICIO, S.A. de C.V. Murguía # 708 P.A., Col. Centro, 68000, Oaxaca Tel: 01(52)95-15-15-22-22 Fax: 01(52)95-15-13-67-00 E-Mail: gpotai2001@hotmail.com
Tijuana: STD Av Ferrocarril Sonora #3780 L-C Col 20 de Noviembre Tijuana, Mexico	FOR USA SUPPORT: ViewSonic® Corporation 381 Brea Canyon Road, Walnut, CA. 91789 USA Tel: 800-688-6688 E-Mail: http://www.viewsonic.com



ViewSonic®